

**Honeywell**

# Granit™ XP 199xi Series

Models: 1990iSR, 1990iXR, 1991iSR, and 1991iXR  
Industrial Area-Imaging Scanners and Bases



---

## User Guide

---

# Disclaimer

Honeywell International Inc. (“HII”) reserves the right to make changes in specifications and other information contained in this document without prior notice, and the reader should in all cases consult HII to determine whether any such changes have been made. The information in this publication does not represent a commitment on the part of HII.

HII shall not be liable for technical or editorial errors or omissions contained herein; nor for incidental or consequential damages resulting from the furnishing, performance, or use of this material. HII disclaims all responsibility for the selection and use of software and/or hardware to achieve intended results.

This document contains proprietary information that is protected by copyright. All rights are reserved. No part of this document may be photocopied, reproduced, or translated into another language without the prior written consent of HII.

Copyright © 2020-2021 Honeywell International Inc. All rights reserved.

Web Address: [sps.honeywell.com](https://sps.honeywell.com).

# Trademarks

Microsoft® Windows® and the Windows logo are trademarks or registered trademarks of Microsoft Corporation.

The Bluetooth® word mark and logos are owned by Bluetooth SIG, Inc.

Apple is a trademark of Apple Inc., registered in the U.S. and other countries.

Other product names or marks mentioned in this document may be trademarks or registered trademarks of other companies and are the property of their respective owners.

# Patents

For patent information, refer to [www.hsmpats.com](https://www.hsmpats.com).

# TABLE OF CONTENTS

Customer Support .....	xiii
Technical Assistance .....	xiii
Product Service and Repair .....	xiii
Limited Warranty .....	xiii
<b>Chapter 1 - Get Started .....</b>	<b>1</b>
About This Manual.....	1
Unpack Your Device.....	1
Features of the Device.....	2
1990i/1991i SR Features.....	2
1990i/1991i XR Features.....	2
Connect a Corded Device.....	2
Connect with USB.....	3
Connect with Keyboard Wedge .....	4
Connect with RS232 Serial Port .....	5
Connect with RS485.....	6
Mount a CCB22-100BT-03N Charge Base .....	8
Reading Techniques.....	8
Granit XP SR.....	9
Granit XP XR .....	10
Menu Barcode Security Settings .....	10
Set Custom Defaults.....	10
Reset the Custom Defaults.....	11

**Chapter 2 - Program the Interface..... 13**

- Introduction ..... 13
- Program the Interface - Plug and Play ..... 13
- Keyboard Wedge ..... 13
- Laptop Direct Connect ..... 14
- RS232 Serial Port..... 14
- RS485..... 14
- USB IBM SurePos ..... 15
- USB PC or Macintosh Keyboard ..... 16
- USB HID..... 16
- USB Serial..... 16
  - CTS/RTS Emulation ..... 17
  - ACK/NAK Mode..... 17
  - USBXNN..... 17
- Verifone® Ruby Terminal..... 18
- Gilbarco® Terminal..... 18
- Honeywell Bioptic Aux Port ..... 18
- Datalogic™ Magellan® Aux Port..... 19
- Wincor Nixdorf Terminal..... 19
- Wincor Nixdorf Beetle™ Terminal ..... 19
- Wincor Nixdorf RS232 Mode A..... 20
- Keyboard Country Layout..... 20
- Keyboard Wedge Modifiers ..... 27
  - ALT Mode..... 27
- Keyboard Style ..... 28
- Keyboard Conversion ..... 29
- Control Character Output..... 30
- Keyboard Modifiers..... 30
- RS232 Modifiers ..... 32
  - RS232 Baud Rate ..... 32
  - RS232 Word Length: Data Bits, Stop Bits, and Parity ..... 33

RS232 Receiver Time-Out.....	34
RS232 Handshake .....	35
RS232 Timeout.....	35
XON/XOFF .....	36
ACK/NAK.....	36
Scanner to Bioptic Communication .....	36
Scanner-Biopic Packet Mode.....	37
Scanner-Biopic ACK/NAK Mode.....	37
Scanner-Biopic ACK/NAK Timeout .....	37

## **Chapter 3 - Cordless System Operation .....39**

How the Cordless Charge Base Works.....	39
Pair with a Honeywell Vehicle Mount Computer.....	39
Legacy Mode .....	39
Compatibility Mode .....	40
Replace a Linked Scanner .....	40
Communication Between the Cordless System and the Host.....	40
Program the Scanner and Base or Access Point .....	41
RF (Radio Frequency) Module Operation.....	41
System Conditions.....	42
Page Button.....	43
Temporary Streaming Presentation Timeout.....	43
Charge Information.....	44
Battery Information for the Granit XP 1991iSR and 1991iXR .....	44
Battery Recommendations .....	44
Safety Precautions for Lithium Batteries.....	44
Proper Disposal of the Battery .....	45
Beeper and LED Sequences and Meaning .....	45
Scanner Communication and Scanning .....	46
Base/Access Point Communication and Scanning .....	47
Base Power Communication Indicator .....	47
About the Bluetooth Status and Battery Icons.....	48
About the Bluetooth Status Icon .....	48

About the Battery Status Icon .....	48
Reset Scanner .....	49
Base Charge Modes .....	49
Page .....	50
Page Mode .....	50
Page Pitch .....	50
Error Indicators.....	51
Beeper Pitch - Base Error .....	51
Number of Beeps - Base Error .....	51
Scanner Report.....	51
Scanner Address .....	52
Base or Access Point Address .....	52
Scanner Modes.....	52
Charge Only Mode .....	52
Charge and Link Mode.....	53
Linked Modes .....	53
Unlink the Scanner.....	54
Override Locked Scanner .....	54
Out-of-Range Alarm.....	54
Alarm Sound Type .....	55
Scanner Power Time-Out Timer.....	55
Flexible Power Management.....	57
Granit XP 1990i and 1991i.....	57
Batch Mode .....	58
Batch Mode Beep .....	59
Batch Mode Storage .....	59
Batch Mode Quantity.....	60
Enter Quantities.....	60
Batch Mode Output Order .....	62
Total Records.....	62
Delete Last Code .....	62
Clear All Codes .....	62
Transmit Records to Host .....	63

Batch Mode Transmit Delay .....	63
Multiple Scanner Operation .....	63
Scanner Name.....	64
Application Work Groups .....	65
Application Work Group Selection .....	65
Reset the Factory Defaults: All Application Work Groups .....	66
Reset the Custom Defaults: All Application Work Groups .....	67
Use the Scanner with Bluetooth Devices.....	67
Bluetooth Secure Simple Pairing (SSP).....	67
Connect with Bluetooth Device Directly.....	68
Virtual Keyboard.....	70
Bluetooth HID Keyboard Disconnect.....	70
Pair with Bluetooth Low Energy (BLE) Devices.....	70
Bluetooth Serial Port - PCs/Laptops.....	71
PDAs/Mobility Systems Devices .....	71
Change the Scanner's Bluetooth PIN Code .....	71
Minimize Bluetooth/ISM Band Network Activity .....	71
Auto Reconnect Mode .....	72
Maximum Link Attempts .....	72
Relink Time-Out .....	73
Bluetooth/ISM Network Activity Examples.....	73
Host Acknowledgment.....	74
Host ACK On/Off .....	76
Host ACK Timeout .....	76
Host ACK Responses .....	76

## **Chapter 4 - Input/Output Settings .....** **77**

Power Up Beeper .....	77
Beep on BEL Character .....	78
Trigger Click.....	78
Good Read and Error Indicators.....	78
Beeper – Good Read .....	78
Beeper Volume – Good Read .....	79

Beeper Pitch – Good Read .....	79
Vibrate – Good Read.....	80
Beeper Pitch – Error .....	80
Beeper Duration – Good Read.....	81
LED – Good Read .....	81
Number of Beeps – Good Read.....	81
Number of Beeps – Error.....	81
Good Read Delay .....	82
User-Specified Good Read Delay.....	82
Trigger Modes .....	83
Manual Trigger.....	83
Trigger Toggle .....	83
Serial Trigger .....	85
Trigger Mode 11.....	85
Presentation Mode.....	86
Triggered Presentation Mode.....	86
Presentation LED Behavior after Decode.....	86
Presentation Centering.....	87
Near-Far Camera Modes (XR Models only).....	88
Near Camera Only.....	89
Far Camera Only.....	89
Automatic Switching Between Near and Far Camera Channels (with steady illumination) .....	89
Alternate Switching Between Near and Far Camera Channels (with extra far field illumination).....	89
Poor Quality Codes.....	90
Poor Quality 1D Codes .....	90
Poor Quality PDF Codes .....	90
Low Resolution PDF Codes .....	90
CodeGate™.....	91
Streaming Presentation™ Mode .....	91
Hands Free Time-Out.....	92
Reread Delay.....	92
User-Specified Reread Delay.....	93



2D Reread Delay .....	93
Character Activation .....	93
Activation Character.....	94
End Character Activation After Good Read.....	94
Character Activation Timeout.....	95
Character Deactivation .....	95
Deactivation Character .....	95
Illumination Lights.....	96
Aimer Delay.....	96
User-Specified Aimer Delay.....	97
Aimer Mode .....	97
Laser Aimer - Scan Duration .....	97
Centering.....	98
Single Code Centering.....	98
Custom Centering .....	98
Preferred Symbology .....	100
High Priority Symbology.....	101
Low Priority Symbology .....	101
Preferred Symbology Time-out.....	101
Preferred Symbology Default .....	101
Output Sequence Overview.....	102
Output Sequence Editor .....	102
To Add an Output Sequence.....	102
Output Sequence Editor Commands.....	103
Enter Output Sequence .....	105
Partial Sequence.....	106
Good Read Tone - Output Sequences .....	109
Multiple Symbols .....	110
No Read.....	111
Video Reverse.....	111
Working Orientation.....	112

## **Chapter 5 - Data Edit .....113**

Prefix/Suffix Overview .....	113
Points to Keep In Mind .....	113
Add a Prefix or Suffix:.....	114
Example: Add a Tab Suffix to All Symbologies.....	114
Clear One or All Prefixes or Suffixes .....	114
Add a Carriage Return Suffix to All Symbologies .....	115
Prefix Selections.....	115
Suffix Selections.....	115
Function Code Transmit.....	116
Intercharacter, Interfunction, and Intermessage Delays.....	116
Intercharacter Delay .....	116
User Specified Intercharacter Delay.....	117
Interfunction Delay .....	117
Intermessage Delay.....	118

## **Chapter 6 - Data Format .....119**

Data Format Editor Introduction.....	119
Show Data Format.....	120
Add a Data Format.....	120
Other Programming Selections.....	121
Terminal ID Table.....	122
Data Format Editor Commands.....	122
Send Commands.....	122
Move Commands .....	128
Search Commands .....	129
Miscellaneous Commands.....	132
Data Formatter.....	135
Data Format Non-Match Error Tone .....	136
Primary/Alternate Data Formats .....	137
Single Scan Data Format Change .....	137

## Chapter 7 - Symbologies.....139

All Symbologies.....	140
Message Length Description .....	140
Codabar.....	140
Code 39 .....	143
Interleaved 2 of 5.....	146
NEC 2 of 5 .....	148
Code 93 .....	149
Straight 2 of 5 Industrial (three-bar start/stop) .....	151
Straight 2 of 5 IATA (two-bar start/stop) .....	152
Matrix 2 of 5 .....	153
Code 11 .....	154
Code 128 .....	155
ISBT 128 Concatenation.....	155
GS1-128 .....	157
Telepen .....	158
UPC-A .....	159
UPC-A/EAN-13 with Extended Coupon Code .....	161
Coupon GS1 DataBar Output.....	162
UPC-E0 .....	162
UPC-E1 .....	165
EAN/JAN-13.....	166
ISBN Translate .....	172
EAN/JAN-8 .....	173
MSI .....	175
GS1 DataBar Omnidirectional.....	177
GS1 DataBar Limited.....	177
GS1 DataBar Expanded.....	178
Trioptic Code .....	178
Codablock A.....	179
Codablock F.....	180

Label Code.....	180
PDF417 .....	181
MacroPDF417 .....	181
MicroPDF417 .....	182
GS1 Composite Codes .....	182
GS1 Emulation.....	183
TCIF Linked Code 39 (TLC39) .....	184
QR Code.....	185
QR Code with Web Link .....	187
DotCode.....	187
Digimarc Barcode™ .....	188
Data Matrix.....	189
MaxiCode .....	191
Aztec Code .....	192
Chinese Sensible (Han Xin) Code .....	193
Postal Codes - 2D .....	194
Planet Code Check Digit.....	197
Postnet Check Digit.....	197
Australian Post Interpretation.....	198
Postal Codes - Linear .....	198
China Post (Hong Kong 2 of 5) .....	199
Korea Post .....	199

## **Chapter 8 - Imaging Commands ..... 201**

Single-Use Basis .....	201
Command Syntax .....	201
Image Snap - IMGSNP.....	202
IMGSNP Modifiers .....	202
Image Ship - IMGSHIP .....	205
IMGSHIP Modifiers .....	206
Image Size Compatibility .....	213
Intelligent Signature Capture - IMGBOX .....	214

Signature Capture Optimize .....	214
IMGBOX Modifiers .....	215
RF Default Imaging Device .....	219

## **Chapter 9 - Utilities..... 221**

To Add a Test Code I.D. Prefix to All Symbologies.....	221
Show Software Revision .....	221
Test Menu.....	221
TotalFreedom.....	222
Application Plug-Ins (Apps).....	222
EZConfig for Scanning Introduction .....	223
Configure with EZConfig for Scanning.....	223
Reset the Factory Defaults .....	224

## **Chapter 10 - Serial Programming Commands..... 225**

Conventions .....	225
Menu Command Syntax.....	225
Query Commands .....	226
Trigger Commands.....	228
Reset the Custom Defaults .....	229
Menu Commands .....	230

## **Chapter 11 - Product Specifications..... 259**

Granit XP SR and Granit XP XR 1990i Corded Scanner Product Specifications	259
Granit XP SR and Granit XP XR 1991i Cordless Scanner Product Specifications	260
CCB22-100BT-03N/COB22 Charge Base Product Specifications .....	262
Depth of Field Charts .....	263
Granit XP SR Performance.....	263
Granit XP XR Performance .....	264
Standard Connector Pinouts.....	266
Keyboard Wedge .....	266
Serial Output .....	266
RS485 Output.....	267

USB .....	267
Required Safety Labels .....	268
Scanner .....	268
CCB22-100BT-03N-BF Base.....	269

**Chapter 12 - Maintenance and Troubleshooting .....271**

Repairs .....	271
Maintenance.....	271
Clean the Scanner.....	271
Clean the Window .....	272
Inspect Cords and Connectors .....	272
Replace Cables in Corded Scanners.....	272
Replace an Interface Cable .....	272
Replace Cables and Batteries in Cordless Systems.....	273
Replace an Interface Cable in a Base.....	273
Change a Scanner Battery.....	273
Troubleshoot a Corded Scanner .....	273
Troubleshoot a Cordless System .....	274
Troubleshoot a Base.....	274
Troubleshoot a Cordless Scanner.....	274

**Chapter A - Reference Charts .....277**

Symbology Charts .....	277
Linear Symbologies.....	277
2D Symbologies.....	279
Postal Symbologies .....	279
ASCII Conversion Chart (Code Page 1252).....	280
Lower ASCII Reference Table .....	281
ISO 2022/ISO 646 Character Replacements.....	284
Keyboard Key References .....	286

**Sample Symbols .....287**

**Programming Chart.....289**

# Customer Support

## Technical Assistance

To search our knowledge base for a solution or to log in to the Technical Support portal and report a problem, go to [www.hsmcontactsupport.com](http://www.hsmcontactsupport.com).

For our latest contact information, see [sps.honeywell.com](http://sps.honeywell.com).

## Product Service and Repair

Honeywell International Inc. provides service for all of its products through service centers throughout the world. To obtain warranty or non-warranty service, return your product to Honeywell (postage paid) with a copy of the dated purchase record. To learn more, go to [sps.honeywell.com](http://sps.honeywell.com) and select **Support**.

## Limited Warranty

For warranty information, go to [www.sps.honeywell.com](http://www.sps.honeywell.com) and click **Support > Warranties**.





## About This Manual

This User Guide provides installation and programming instructions for the Granit™ XP 1990iSR and 1990iXR corded industrial area-imaging scanners and the Granit XP 1991iSR and 1991iXR cordless industrial area-imaging scanners. Product specifications, dimensions, warranty, and customer support information are also included.

Honeywell barcode scanners are factory programmed for the most common terminal and communications settings. If you need to change these settings, programming is accomplished by scanning the barcodes in this guide.

An asterisk (\*) next to an option indicates the default setting.

## Unpack Your Device

After you open the shipping carton containing the product, take the following steps:

- Check for damage during shipment. Report damage immediately to the carrier who delivered the carton.
- Make sure the items in the carton match your order.
- Save the shipping container for later storage or shipping.

# Features of the Device

## 1990i/1991i SR Features

Provides extreme performance scanning even on damaged and low-quality barcodes. The SR is built to survive harsh treatment, including drops and extreme temperatures. Ideally suited to normal near-field scanning operations on 1D and 2D barcodes. For more information and specifications, see [Depth of Field Charts](#) on page 263.

## 1990i/1991i XR Features

Like the SR, provides extreme performance scanning even on damaged and low-quality barcodes. The XR is built to survive harsh treatment, including drops and extreme temperatures. Ideally suited to normal near-field scanning operations on 1D and 2D barcodes, with an expanded range scanning 100% UPC to 1.5m (5 ft) and 100 mil Code 39 barcodes to 10 M (33 ft). For more information and specifications, see [Depth of Field Charts](#) on page 263.

For information about Bluetooth connection, see [Connect with Bluetooth Device Directly](#) on page 68.

## Connect a Corded Device

When connecting the corded scanner, make sure the cable is pushed tightly into the scanner. Loosen the locking plate and slide it over the base of the cable connector to lock the cable in place. Tighten the screw.

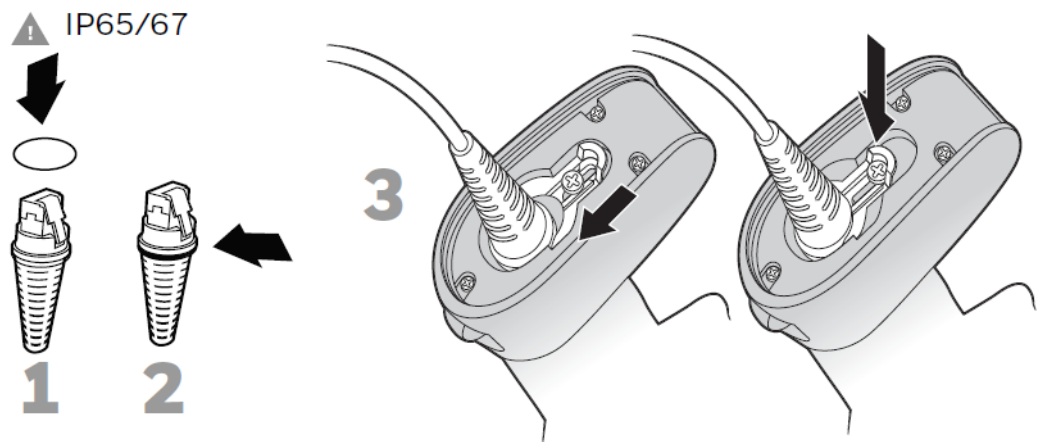

**Note:** It is important to insert the red O-ring onto the end of the communication cable as shown, and make sure that the O-ring cannot be seen after the cable is inserted into the scanner. This ensures proper assembly and IP65/67 compliance function.

# Connect with USB

A scanner or a cordless base can be connected to the USB port of a computer.

1. Connect the appropriate interface cable to the device first, then to the computer.

## Corded Granit XP Scanner USB Connection:

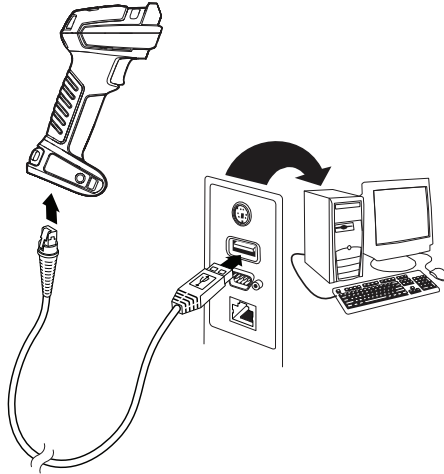

2. If you are connecting a CCB22-100BT-03N or a COB22-100BT-03N base horizontally, make sure the cables are secured in the wireways in the bottom of the cordless base and the base sits flat on a horizontal surface.

## CCB22-100BT-03N Base USB Connection:

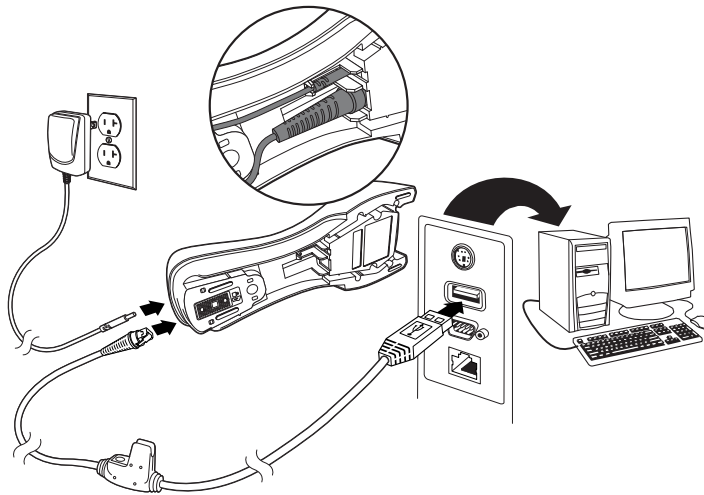

**Note:** The power supply must be ordered separately, if needed.

3. The scanner beeps.
4. Verify the scanner or cordless base operation by scanning a barcode from the [Sample Symbols](#), beginning on page 287.

The unit defaults to a USB PC Keyboard. Refer to [page 16](#) for other USB terminal settings.

For additional USB programming and technical information, refer to “USB Application Note,” available at [www.honeywellaidc.com](http://www.honeywellaidc.com).

## Connect with Keyboard Wedge

A scanner or cordless base can be connected between the keyboard and PC as a “keyboard wedge,” where the scanner provides data output that is similar to keyboard entries. The following is an example of a keyboard wedge connection:

1. Turn off power and disconnect the keyboard cable from the back of the terminal/computer.
2. Connect the appropriate interface cable to the device and to the terminal/computer.

### **Corded Granit XP Scanner Keyboard Wedge Connection:**

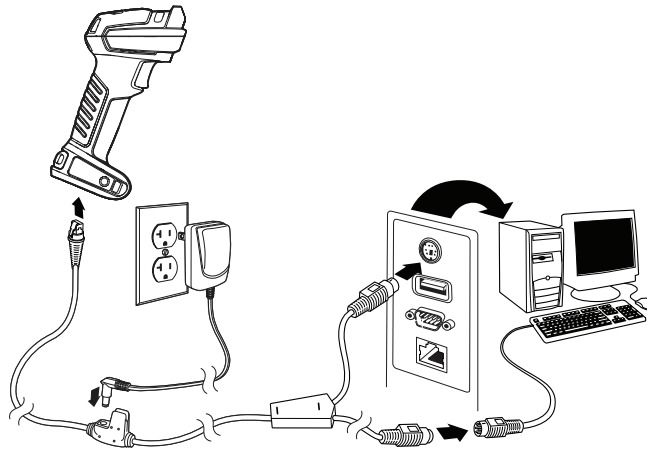

**Note:** The power supply must be ordered separately, if needed.

### CCB22-100BT-03N Base Keyboard Wedge Connection:

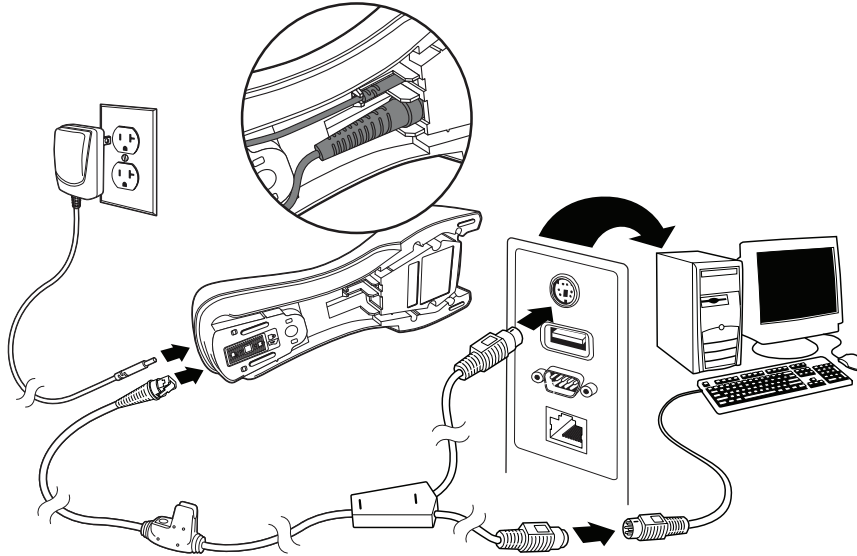

3. Turn the terminal/computer power back on. The scanner beeps.
4. Verify the scanner or cordless base operation by scanning a barcode from the [Sample Symbols](#), beginning on page 287.

The unit defaults to an IBM PC AT and compatibles keyboard wedge interface with a USA keyboard. A carriage return (CR) suffix is added to barcode data.

## Connect with RS232 Serial Port

1. Turn off power to the terminal/computer.
2. Connect the appropriate interface cable to the scanner.

**Note:** For the scanner or cordless base to work properly, you must have the correct cable for your type of terminal/computer.

### Corded Granit XP Scanner RS232 Serial Port Connection:

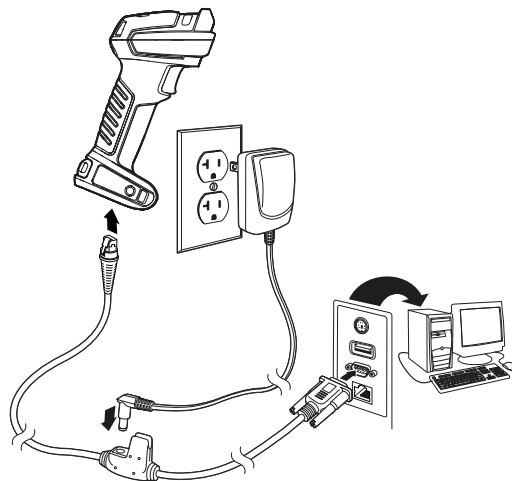

3. If you are connecting a the base horizontally, make sure the cables are secured in the wireways in the bottom of the cordless base and the base sits flat on a horizontal surface.

**CCB22-100BT-03N Base RS232 Serial Port Connection:**

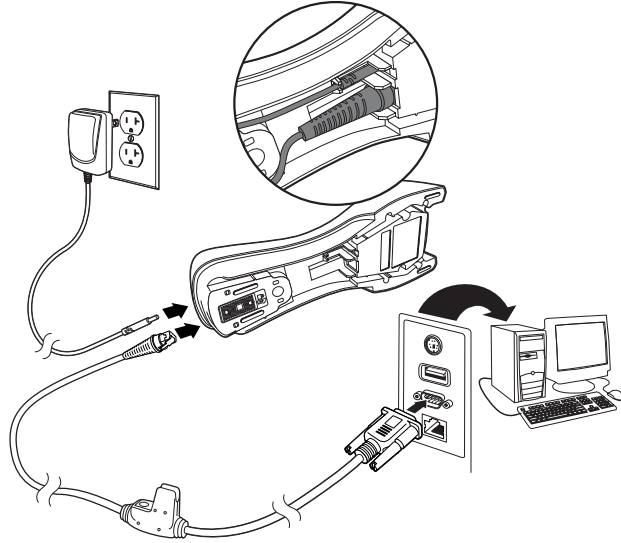

**Note:** *The power supply must be ordered separately, if needed.*

4. Plug the serial connector into the serial port on your computer. Tighten the two screws to secure the connector to the port.
5. Once the scanner or cordless base has been fully connected, power up the computer.

This interface programs 115,200 baud, 8 data bits, no parity, and 1 stop bit.

## Connect with RS485

A Granit XP scanner or cordless base can be connected for an IBM POS terminal interface.

1. Connect the appropriate interface cable to the device, then to the computer.

**Corded Granit XP Scanner RS485 Connection:**

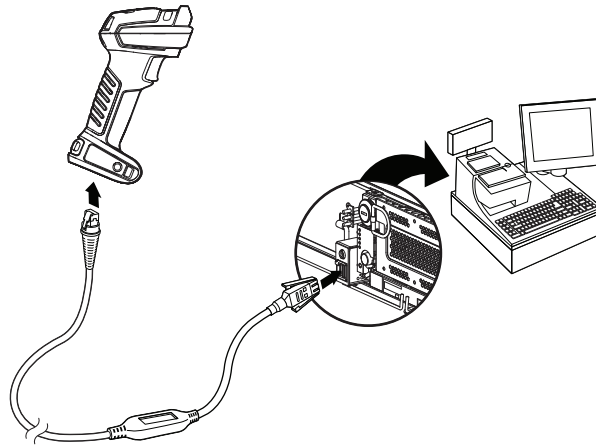

2. If you are connecting the base horizontally, make sure the cables are secured in the wireways in the bottom of the cordless base and the base sits flat on a horizontal surface.

**CCB22-100BT-03N Base RS485 Serial Port Connection:**

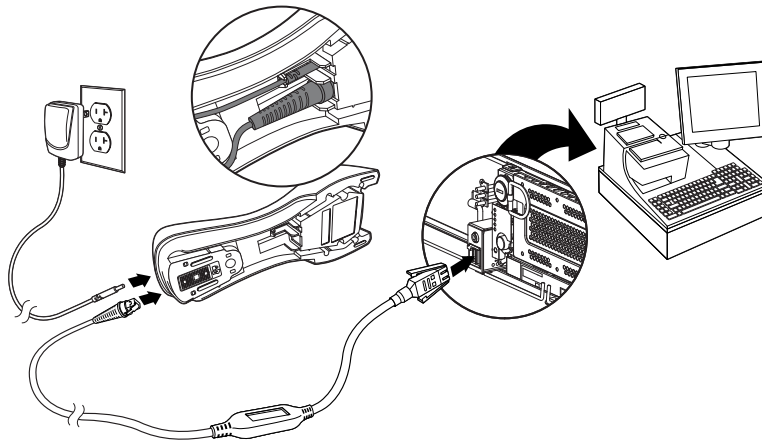

**Note:** The power supply must be ordered separately, if needed.

3. Turn the terminal/computer power back on. The scanner beeps.
4. Verify the scanner or cordless base operation by scanning a barcode from the [Sample Symbols](#), beginning on page 287. The scanner beeps once.

For further RS485 settings, refer to [RS485](#), page 14.

# Mount a CCB22-100BT-03N Charge Base

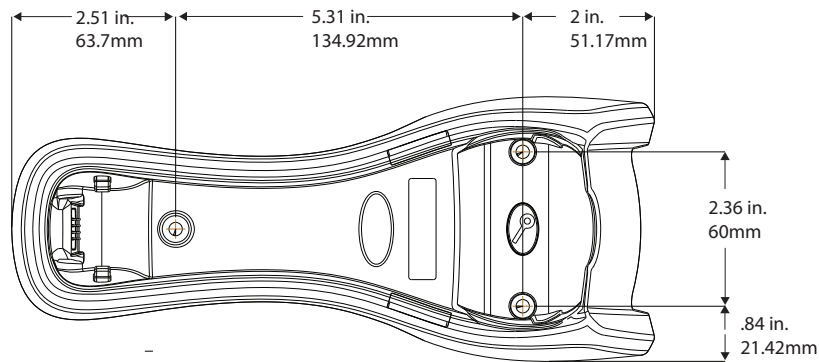

## Reading Techniques

The Granit XP SR scanners have an aimer that projects a bright red spot/cross and corner indicators that correspond to the scanner's field of view. The aiming spot/cross should be centered over the bar code, with the entire bar code falling within the corner indicators. The scanner can be positioned/rotated in any direction for a good read.

Granit XP XR scanners have an aimer that projects a bright red spot that corresponds to the scanner's center of field of view. The aiming dot should be centered over the bar code. The scanner can be positioned/rotated in any direction for a good read.



# Granit XP SR

Linear Barcodes and 2D matrix symbol with aiming dot.

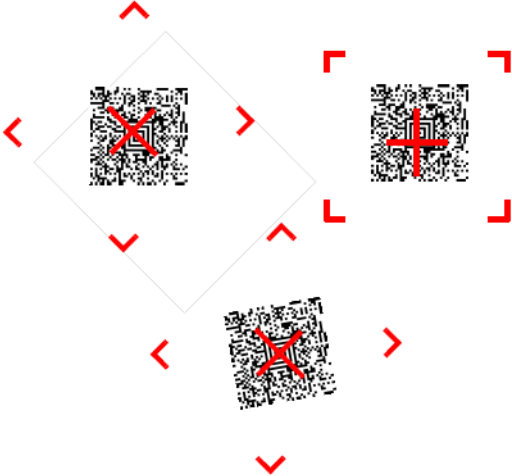
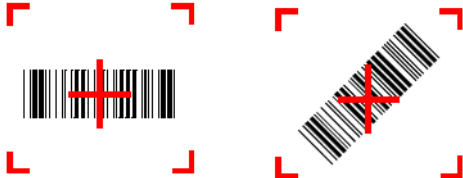

# Granit XP XR

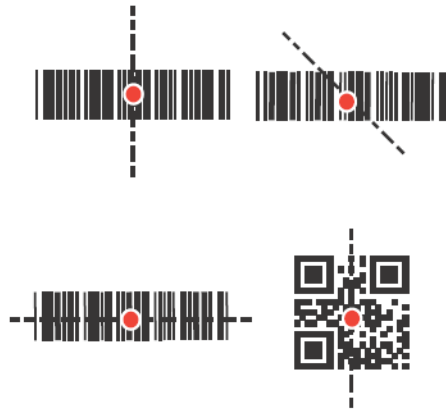

## Menu Barcode Security Settings

Honeywell scanners are programmed by scanning menu barcodes or by sending serial commands to the scanner. If you want to restrict the ability to scan menu codes, you can use the Menu Barcode Security settings. Contact the nearest technical support office (see [Technical Assistance](#) on page xiii) for further information.

## Set Custom Defaults

You have the ability to create a set of menu commands as your own, custom defaults. To do so, scan the **Set Custom Defaults** barcode below before scanning the menu commands for your custom defaults. If a menu command requires scanning numeric codes from the [Programming Chart](#), beginning on page 289, then a

**Save** code, that entire sequence will be saved to your custom defaults. When you have entered all the commands you want to save for your custom defaults, scan the **Save Custom Defaults** barcode.



**Note:** When using a cordless system, the Custom Defaults settings apply to all workgroups. Scanning the **Save Defaults** barcode also causes both the scanner and the base or Access Point to perform a reset and become unlinked. The scanner must be placed in its base to re-establish the link before any setup codes are entered. If using an Access Point, the linking barcode must be scanned. See [Cordless System Operation](#) beginning on page 39 for additional information.

You may have a series of custom settings and want to correct a single setting. To do so, just scan the new setting to overwrite the old one. For example, if you had previously saved the setting for Beeper Volume at Low to your custom defaults, and decide you want the beeper volume set to High, just scan the **Set Custom Defaults** barcode, then scan the Beeper Volume High menu code, and then **Save Custom Defaults**. The rest of the custom defaults will remain, but the beeper volume setting will be updated.

## Reset the Custom Defaults

If you want the custom default settings restored to your scanner, scan the **Activate Custom Defaults** barcode below. This is the recommended default barcode for most users. It resets the scanner to the custom default settings. If there are no custom defaults, it will reset the scanner to the factory default settings. Any settings that have not been specified through the custom defaults will be defaulted to the factory default settings.



**Note:** If using a cordless system, scanning this barcode also causes both the scanner and the base or Access Point to perform a reset and become unlinked. The scanner must be placed in its base to re-establish the link. If using an Access Point, the linking barcode must be scanned. See [Cordless System Operation](#) beginning on page 39 for additional information.



## Introduction

This chapter describes how to program your system for the desired interface.

## Program the Interface - Plug and Play

Plug and Play barcodes provide instant scanner set up for commonly used interfaces.

**Note:** After you scan one of the codes, power cycle the host terminal to have the interface in effect.

## Keyboard Wedge

If you want your system programmed for an IBM PC AT and compatibles keyboard wedge interface with a USA keyboard, scan the barcode below. Keyboard wedge is the default interface.

**Note:** The following barcode also programs a carriage return (CR) suffix.



PAP\_AT.

IBM PC AT and Compatibles with  
CR suffix

# Laptop Direct Connect

For most laptops, scanning the **Laptop Direct Connect** barcode allows operation of the scanner in parallel with the integral keyboard. The following **Laptop Direct Connect** barcode also programs a carriage return (CR) suffix and turns on Emulate External Keyboard (page 29).



PAPLTD.

Laptop Direct Connect  
with CR suffix

# RS232 Serial Port

The **RS232 Interface** barcode is used when connecting to the serial port of a PC or terminal. The following **RS232 Interface** barcode also programs a carriage return (CR) and a line feed (LF) suffix, baud rate, and data format as indicated below. It also changes the trigger mode to manual.

Option	Setting
Baud Rate	115,200 bps
Data Format	8 data bits, no parity bit, 1 stop bit



PAP232.

RS232 Interface

# RS485

Scan one of the following “Plug and Play” codes to program the scanner for an IBM POS terminal interface.

**Note:** After scanning one of these codes, you must power cycle the cash register.



PAPP5B.

IBM Port 5B Interface



PAP9B1.

IBM Port 9B  
HHBCR-1 Interface



Each barcode above also programs the following suffixes for each symbology:

Symbology	Suffix	Symbology	Suffix
EAN 8	0C	Code 39	00 0A 0B
EAN 13	16	Interleaved 2 of 5	00 0D 0B
UPC A	0D	Code 128 *	00 0A 0B
UPC E	0A	Code 128 **	00 18 0B
		MaxiCode	00 2F 0B

\* Suffixes programmed for Code 128 with IBM 4683 Port 5B, IBM 4683 Port 9B HHBCR-1, and IBM 4683 Port 17 Interfaces

\*\* Suffixes programmed for Code 128 with IBM 4683 Port 9 HHBCR-2 Interface

## USB IBM SurePos

Scan one of the following “Plug and Play” codes to program the scanner for an IBM SurePos (USB handheld scanner) or IBM SurePos (USB tabletop scanner) interface.

**Note:** After scanning one of these codes, you must power cycle the cash register.



Each barcode above also programs the following suffixes for each symbology:

Symbology	Suffix	Symbology	Suffix
EAN 8	0C	Code 39	00 0A 0B
EAN 13	16	Interleaved 2 of 5	00 0D 0B
UPC A	0D	Code 128	00 18 0B
UPC E	0A	Code 39	00 0A 0B

# USB PC or Macintosh Keyboard

Scan one of the following codes to program the scanner for USB PC Keyboard or USB Macintosh Keyboard. Scanning these codes also adds a CR suffix.



PAP124.  
USB Keyboard (PC)



PAP125.  
USB Keyboard (Mac)



TRMUSB134.  
USB Japanese Keyboard (PC)

# USB HID

Scan the following code to program the scanner for USB HID Barcode scanners.



PAP131.  
USB HID Barcode Scanner

# USB Serial

If you are using a Microsoft® Windows® PC, you will need to download the latest driver from the Honeywell website ([www.honeywellaidc.com](http://www.honeywellaidc.com)) and go to **Get Resources - Downloads - Software**. The driver will use the next available COM Port number. Apple® Macintosh computers recognize the scanner as a USB CDC class device and automatically use a class driver.

After the driver is downloaded, scan the following code to program the scanner to emulate a regular RS232-based COM Port.



TRMUSB130.  
USB Serial

No extra configuration (e.g., baud rate) is necessary.

**Note:** *If you scan the USB Serial barcode either with an older Honeywell serial driver, or no driver installed, you may no longer be able to scan barcodes. If this happens, either uninstall the older driver versions and install the latest driver, or delete the specific device entry in Device Manager.*



# CTS/RTS Emulation

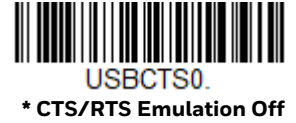
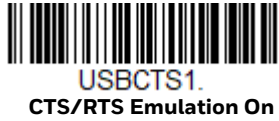

# ACK/NAK Mode



# USBXNN

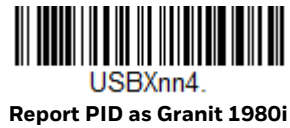
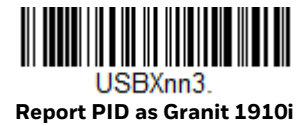
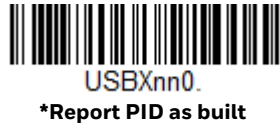

# Verifone® Ruby Terminal

Scan the following Plug and Play code to program the scanner for a Verifone Ruby terminal. This barcode sets the baud rate to 1200 bps and the data format to 8 data bits, mark parity bit, 1 stop bit. It also adds a line feed (LF) suffix and programs the following prefixes for each symbology:

Symbology	Prefix
UPC-A	A
UPC-E	A
EAN-8	FF
EAN-13	F



PAPRBY.

Verifone Ruby Settings

# Gilbarco® Terminal

Scan the following Plug and Play code to program the scanner for a Gilbarco terminal. This barcode sets the baud rate to 2400 bps and the data format to 7 data bits, even parity, 2 stop bits. It also adds a carriage return (CR) suffix and programs the following prefixes for each symbology:

Symbology	Prefix
UPC-A	A
UPC-E	EO
EAN-8	FF
EAN-13	F



PAPGLB.

Gilbarco Settings

# Honeywell Bioptic Aux Port

Scan the following Plug and Play code to program the scanner for a Honeywell bioptic scanner auxiliary port configuration. This barcode sets the baud rate to 38400 bps and the data format to 8 data bits, no parity, 1 stop bit.



PAPBIO.

Honeywell Bioptic Settings

# Datalogic™ Magellan® Aux Port

Scan the following Plug and Play code to program the scanner for a Datalogic Magellan auxiliary port configuration. This barcode sets the baud rate to 9600 bps and the data format to 8 data bits, no parity, 1 stop bit.



PAPMAG.

Datalogic Magellan Settings

## Wincor Nixdorf Terminal

Scan the following Plug and Play code to program the scanner for a Wincor Nixdorf terminal. This barcode sets the baud rate to 9600 bps and the data format to 8 data bits, no parity, 1 stop bit.



PAPWNX.

Wincor Nixdorf Terminal Settings

## Wincor Nixdorf Beetle™ Terminal

Scan the following Plug and Play code to program the scanner for a Wincor Nixdorf Beetle terminal. The following prefixes are programmed for each symbology:

Symbology	Prefix	Symbology	Prefix
Aztec Code	V	Interleaved 2 of 5	I
Codabar	N	MaxiCode	T
Code 93	L	MicroPDF417	S
Code 128	K	PDF417	Q
Data Matrix	R	QR Code	U
EAN-8	B	Straight 2 of 5 IATA	H
EAN-13	A	UPC-A	A0
GS1 DataBar	E	UPC-E	C
GS1-128	P	All other barcodes	M



PAPBTL.

Wincor Nixdorf Beetle Settings

# Wincor Nixdorf RS232 Mode A

Scan the following Plug and Play code to program the scanner for a Wincor Nixdorf RS232 Mode A terminal. This barcode sets the baud rate to 9600 bps and the data format to 8 data bits, odd parity, 1 stop bit. The following prefixes are programmed for each symbology:

Symbology	Prefix	Symbology	Prefix
Code 128	K	EAN-13	A
Code 93	L	GS1-128	K
Codabar	N	Interleaved 2 of 5	I
UPC-A	A0	Straight 2 of 5 IATA	H
UPC-E	C	GS1 DataBar	E
EAN-8	B		
All other barcodes	M		



PAPWMA.

Wincor Nixdorf RS232 Mode A  
Settings

## Keyboard Country Layout

If your interface is USB Keyboard or Keyboard Wedge, your keyboard layout default is a US keyboard. To change this layout, scan the appropriate Keyboard Country barcode below. By default, national character replacements are used for the following characters: # \$ @ [ \ ] ^ ' { | } ~. Refer to the ["ISO 2022/ISO 646 Character Replacements" on page A-284](#) to view the character replacements for each country.

### Keyboard Countries



KBDCTY0.

\* United States



KBDCTY35.

Albania



KBDCTY81.

Azeri (Cyrillic)



KBDCTY80.

Azeri (Latin)

## Keyboard Countries (Continued)



KBDCTY82.  
Belarus



KBDCTY33.  
Bosnia



KBDCTY59.  
Brazil (MS)



KBDCTY53.  
Bulgaria (Latin)



KBDCTY18.  
Canada (French)



KBDCTY32.  
Croatia



KBDCTY1.  
Belgium



KBDCTY16.  
Brazil



KBDCTY52.  
Bulgaria (Cyrillic)



KBDCTY54.  
Canada (French legacy)



KBDCTY55.  
Canada (Multilingual)



KBDCTY15.  
Czech

## Keyboard Countries (Continued)



**KBDCTY40.**  
**Czech (Programmers)**



**KBDCTY38.**  
**Czech (QWERTZ)**



**KBDCTY11.**  
**Dutch (Netherlands)**



**KBDCTY83.**  
**Faroese**



**KBDCTY3.**  
**France**



**KBDCTY4.**  
**Germany**



**KBDCTY39.**  
**Czech (QWERTY)**



**KBDCTY8.**  
**Denmark**



**KBDCTY41.**  
**Estonia**



**KBDCTY2.**  
**Finland**



**KBDCTY84.**  
**Gaelic**



**KBDCTY17.**  
**Greek**

## Keyboard Countries (Continued)



KBDCTY64.  
Greek (220 Latin)



KBDCTY65.  
Greek (319 Latin)



KBDCTY63.  
Greek (Latin)



KBDCTY60.  
Greek (Polytonic)



KBDCTY50.  
Hungarian (101 key)



KBDCTY75.  
Iceland



KBDCTY61.  
Greek (220)



KBDCTY62.  
Greek (319)



KBDCTY66.  
Greek (MS)



KBDCTY12.  
Hebrew



KBDCTY19.  
Hungary



KBDCTY73.  
Irish

## Keyboard Countries (Continued)



**KBDCTY56.**  
**Italian (142)**



**KBDCTY28.**  
**Japan ASCII**



**KBDCTY79.**  
**Kyrgyz (Cyrillic)**



**KBDCTY42.**  
**Latvia**



**KBDCTY44.**  
**Lithuania**



**KBDCTY34.**  
**Macedonia**



**KBDCTY5.**  
**Italy**



**KBDCTY78.**  
**Kazakh**



**KBDCTY14.**  
**Latin America**



**KBDCTY43.**  
**Latvia (QWERTY)**



**KBDCTY45.**  
**Lithuania (IBM)**



**KBDCTY74.**  
**Malta**



## Keyboard Countries (Continued)



KBDCTY86.  
Mongolian (Cyrillic)



KBDCTY20.  
Poland



KBDCTY58.  
Polish (Programmers)



KBDCTY25.  
Romania



KBDCTY67.  
Russian (MS)



KBDCTY21.  
SCS



KBDCTY9.  
Norway



KBDCTY57.  
Polish (214)



KBDCTY13.  
Portugal



KBDCTY26.  
Russia



KBDCTY68.  
Russian (Typewriter)



KBDCTY37.  
Serbia (Cyrillic)

## Keyboard Countries (Continued)



KBDCTY36.  
Serbia (Latin)



KBDCTY49.  
Slovakia (QWERTY)



KBDCTY31.  
Slovenia



KBDCTY51.  
Spanish variation



KBDCTY29.  
Switzerland (French)



KBDCTY85.  
Tatar



KBDCTY22.  
Slovakia



KBDCTY48.  
Slovakia (QWERTZ)



KBDCTY10.  
Spain



KBDCTY23.  
Sweden



KBDCTY6.  
Switzerland (German)



KBDCTY27.  
Turkey F

## Keyboard Countries (Continued)



KBDCTY24.  
Turkey Q



KBDCTY76.  
Ukrainian



KBDCTY7.  
United Kingdom



KBDCTY87.  
United States (Dvorak)



KBDCTY88.  
United States (Dvorak left)



KBDCTY89.  
United States (Dvorak right)



KBDCTY30.  
United States (International)



KBDCTY77.  
Uzbek (Cyrillic)

## Keyboard Wedge Modifiers

### ALT Mode

If your barcode contains special characters from the extended ASCII chart, for example, an e with an accent grave (è), you will use ALT Mode. (See [Extended ASCII Characters](#) on page 281.)

**Note:** Scan the ALT mode barcode after scanning the appropriate Keyboard Country code.

If your keystrokes require the ALT key and 3 or 4 characters, scan the **3 Characters** or **4 Characters** barcode. The data is then output with the special character(s) for values 00-255. *Default = Off.*



KBDALT0.

\* Off



KBDALT6.

3 Characters



KBDALT7.

4 Characters

## Keyboard Style

This programs keyboard styles, such as Caps Lock and Shift Lock. If you have used [Keyboard Conversion](#) settings, they will override any of the following Keyboard Style settings. *Default = Regular.*

**Regular** is used when you normally have the Caps Lock key off.



KBDSTY0.

\* Regular

**Caps Lock** is used when you normally have the Caps Lock key on.



KBDSTY1.

Caps Lock

**Shift Lock** is used when you normally have the Shift Lock key on (not common to U.S. keyboards).



KBDSTY2.

Shift Lock

**Caps Lock Shift Enable** is used two different ways. In Europe (KBDCSE0), Shift is used to close caps. In China, Shift is used to switch from Chinese to English (KBDCSE1). *Default = KBDCSE0*



**Automatic Caps Lock** is used if you change the Caps Lock key on and off. The software tracks and reflects if you have Caps Lock on or off. This selection can only be used with systems that have an LED that notes the Caps Lock status (AT keyboards).



**Autocaps via NumLock** barcode should be scanned in countries (e.g., Germany, France) where the Caps Lock key cannot be used to toggle Caps Lock. The NumLock option works similarly to the regular Autocaps, but uses the NumLock key to retrieve the current state of the Caps Lock.

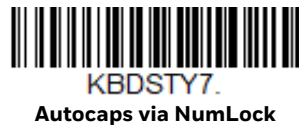

**Emulate External Keyboard** should be scanned if you do not have an external keyboard (IBM AT or equivalent).



**Note:** After scanning the Emulate External Keyboard barcode, you must power cycle your computer.

## Keyboard Conversion

Alphabetic keyboard characters can be forced to be all upper case or all lowercase. So if you have the following barcode: “abc569GK,” you can make the output “ABC569GK” by scanning **Convert All Characters to Upper Case**, or to “abc569gk” by scanning **Convert All Characters to Lower Case**.

These settings override [Keyboard Style](#) selections.

**Note:** If your interface is a keyboard wedge, first scan the menu code for [Automatic Caps Lock](#) (page 29). Otherwise, your output may not be as expected.

Default = Keyboard Conversion Off.



KBDCNV0.

\* Keyboard Conversion Off



KBDCNV1.

Convert All Characters  
to Upper Case



KBDCNV2.

Convert All Characters  
to Lower Case

## Control Character Output

This selection sends a text string instead of a control character. For example, when the control character for a carriage return is expected, the output would display [CR] instead of the ASCII code of 0D. Refer to [ASCII Conversion Chart \(Code Page 1252\)](#) on page 280. Only codes 00 through 1F are converted (the first column of the chart). *Default = Off.*

**Note:** *Control + X (Control + ASCII) Mode overrides this mode.*



KBDNPE1.

Control Character Output On



KBDNPE0.

\* Control Character Output Off

## Keyboard Modifiers

This modifies special keyboard features, such as CTRL+ ASCII codes and Turbo Mode.

**Control + X (Control + ASCII) Mode On:** The scanner sends key combinations for ASCII control characters for values 00-1F. Windows is the preferred mode. All keyboard country codes are supported. DOS mode is a legacy mode, and it does not support all keyboard country codes. New users should use the Windows mode. Refer to [ASCII Conversion Chart \(Code Page 1252\)](#), page 280 for CTRL+ X Values.

**Windows Mode Prefix/Suffix Off:** The scanner sends key combinations for ASCII control characters for values 00-1F, but it does not translate prefix or suffix information.

**Support ALT 3 Digit HEX Mode:** The scanner sends key combinations for ASCII control characters for values 00-1F transmitted as the ALT key and 3 digits.

*Default = Control + X Mode Off.*



KBDCAS2.

Windows Mode Control + X Mode On



KBDCAS0.

\* Control + X Mode Off



KBDCAS1.

DOS Mode Control + X Mode On



KBDCAS3.

Windows Mode Prefix/Suffix



KBDCAS4.

DOS Mode Control + X Mode On with Windows Mode Prefix/Suffix



KBDCAS5.

Supports ALT 3 Digit HEX Mode

**Turbo Mode:** The scanner sends characters to a terminal faster. If the terminal drops characters, do not use Turbo Mode. *Default = Off.*



KBDTMD1.

Turbo Mode On



KBDTMD0.

\* Turbo Mode Off

**Numeric Keypad Mode:** Sends numeric characters as if entered from a numeric keypad. *Default = Off.*



KBDNPS1.

**Numeric Keypad Mode On**



KBDNPS0.

**\* Numeric Keypad Mode Off**

**Automatic Direct Connect Mode:** This selection can be used if you have an IBM AT style terminal and the system is dropping characters. *Default = Off.*



KBDADC1.

**Automatic Direct Connect  
Mode On**



KBDADC0.

**\* Automatic Direct Connect  
Mode Off**

## RS232 Modifiers

### RS232 Baud Rate

Baud Rate sends the data from the scanner to the terminal at the specified rate. The host terminal must be set for the same baud rate as the scanner. *Default = 115,200.*



232BAD0.

**300**



232BAD1.

**600**



232BAD2.

**1200**





## RS232 Word Length: Data Bits, Stop Bits, and Parity

**Data Bits** sets the word length at 7 or 8 bits of data per character. If an application requires only ASCII Hex characters 0 through 7F decimal (text, digits, and punctuation), select 7 data bits. For applications that require use of the full ASCII set, select 8 data bits per character. *Default = 8.*

**Stop Bits** sets the stop bits at 1 or 2. *Default = 1.*

**Parity** provides a means of checking character bit patterns for validity. *Default = None.*





## RS232 Receiver Time-Out

The unit stays awake to receive data until the RS232 Receiver Time-Out expires. A manual or serial trigger resets the time-out. When an RS232 receiver is sleeping, a character may be sent to wake up the receiver and reset the time-out. A transaction on the CTS line will also wake up the receiver. The receiver takes 300 milliseconds to completely come up. Change the RS232 receiver time-out by scanning the barcode below, then scanning digits from the [Programming Chart](#), beginning on page 289, then scanning **Save**. The range is 0 to 300 seconds. *Default = 0 seconds (no time-out - always on).*



## RS232 Handshake

RS232 Handshaking allows control of data transmission from the scanner using software commands from the host device. When RTS/CTS is turned Off, no data flow control is used.

**Flow Control, No Timeout:** The scanner asserts RTS when it has data to send, and will wait indefinitely for CTS to be asserted by the host.

**Two-Direction Flow Control:** The scanner asserts RTS when it is OK for the host to transmit. The host asserts CTS when it is OK for the device to transmit.

**Flow Control with Timeout:** The scanner asserts RTS when it has data to send and waits for a delay (see [RS232 Timeout](#) on page 35) for CTS to be asserted by the host. If the delay time expires and CTS is not asserted, the device transmit buffer is cleared and scanning may resume. *Default = RTS/CTS Off.*



Flow Control, No Timeout



Two-Direction Flow Control



Flow Control with Timeout



\* RTS/CTS Off

## RS232 Timeout

When using **Flow Control with Timeout**, you must program the length of the delay you want to wait for CTS from the host. Set the length (in milliseconds) for a timeout by scanning the barcode below, then setting the timeout (from 1-5100 milliseconds) by scanning digits from the [Programming Chart](#), beginning on page 289, then scanning **Save**.



RS232 Timeout

## XON/XOFF

Standard ASCII control characters can be used to tell the scanner to start sending data (XON/XOFF On) or to stop sending data (XON/XOFF Off). When the host sends the XOFF character (DC3, hex 13) to the scanner, data transmission stops. To resume transmission, the host sends the XON character (DC1, hex 11). Data transmission continues where it left off when XOFF was sent. *Default = XON/XOFF Off.*



232XON1.  
XON/XOFF On



232XON0.  
\* XON/XOFF Off

## ACK/NAK

After transmitting data, the scanner waits for an ACK character (hex 06) or a NAK character (hex 15) response from the host. If ACK is received, the communications cycle is completed and the scanner looks for more barcodes. If NAK is received, the last set of barcode data is retransmitted and the scanner waits for ACK/NAK again. Turn on the ACK/NAK protocol by scanning the **ACK/NAK On** barcode below. To turn off the protocol, scan **ACK/NAK Off**. *Default = ACK/NAK Off.*



232ACK1.  
ACK/NAK On



232ACK0.  
\* ACK/NAK Off

## Scanner to Bioptic Communication

The following settings are used to set up communication between Honeywell scanners and bioptic scanners.

**Note:** *The scanner's baud rate must be set to 38400 and the RS232 timeout must be set to 3000 in order to communicate with a bioptic scanner. See "RS232 Modifiers" on page 32, and [RS232 Timeout](#) on page 35 for further information.*

## Scanner-Bioptic Packet Mode

**Packet Mode On** must be scanned to set the scanner's format so it is compatible with a bioptic scanner. *Default = Packet Mode Off.*



232PKT0.

\* Packet Mode Off



232PKT2.

Packet Mode On

## Scanner-Bioptic ACK/NAK Mode

**Bioptic ACK/NAK On** must be scanned so the scanner will wait for an ACK or NAK from a bioptic scanner after each packet is sent. The Scanner-Bioptic ACK/NAK Timeout (below) controls how long the scanner will wait for a response. *Default = Bioptic ACK/NAK Off.*



232NAK0.

\* Bioptic ACK/NAK Off



232NAK1.

Bioptic ACK/NAK On

## Scanner-Bioptic ACK/NAK Timeout

This allows you to set the length (in milliseconds) for a timeout for a bioptic scanner's ACK/NAK response. Scan the barcode below, then set the timeout (from 1-30,000 milliseconds) by scanning digits from the [Programming Chart](#), beginning on page 289, then scanning **Save**. *Default = 5100.*



232DLK.

ACK/NAK Timeout



# CORDLESS SYSTEM OPERATION

## How the Cordless Charge Base Works

A CCB22-100BT-03N cordless charge base provides the link between the cordless scanner and the host system. The base contains an interface assembly and an RF communication module. The RF communication module performs the data exchange between the cordless scanner and the interface assembly. The control assembly coordinates the central interface activities including: transmitting/receiving commands and data to/from the host system, performing software activities (parameter menuing, visual indicator support, power-on diagnostics), and data translation required for the host system.

## Pair with a Honeywell Vehicle Mount Computer

A Granit XP SR or Granit XP XR can pair with Honeywell vehicle mounted computers. Scan the EZPairing barcode that is either supplied with the vehicle mount computer, attached to the vehicle mount computer, or displayed on the screen. The EZPairing barcode begins with {FNC3} LnkB, followed by 12 digits, like the sample below.



## Legacy Mode

In Legacy Mode, the scanner works in SPP.



## Compatibility Mode

In Compatibility Mode, the scanner can work with HID, SPP, or other Bluetooth profiles. Bluetooth needs to be set manually before scanning this barcode.



LKBMOD1.

**Compatibility Mode**  
(optional)

## Replace a Linked Scanner

If you need to replace a broken or lost scanner that is linked to a base or an Access Point, scan the **Override Locked Scanner** barcode below with a new scanner and place that scanner in the base, or scan the Access Point linking barcode. The locked link will be overridden, the broken or lost scanner's link with the base or Access Point will be removed, and the new scanner will be linked.



BT\_RPL1.

**Override Locked Scanner**  
(Single Scanner)

## Communication Between the Cordless System and the Host

The cordless scanner provides immediate feedback in the form of a “good read” indication with a green LED on the scanner and an audible beep. The scanner also vibrates, if programmed to do so. This indicates that the barcode has been scanned correctly and the base or Access Point has acknowledged receiving the data. This is possible since the cordless system provides two-way communication between the scanner and the base or Access Point.



When data is scanned, the data is sent to the host system via the base or Access Point. The cordless scanner recognizes data acknowledgment (ACK) from the base or Access Point. If it cannot be determined that the data has been properly sent to the base or Access Point, the scanner issues an error indication. You must then check to see if the scanned data was received by the host system.

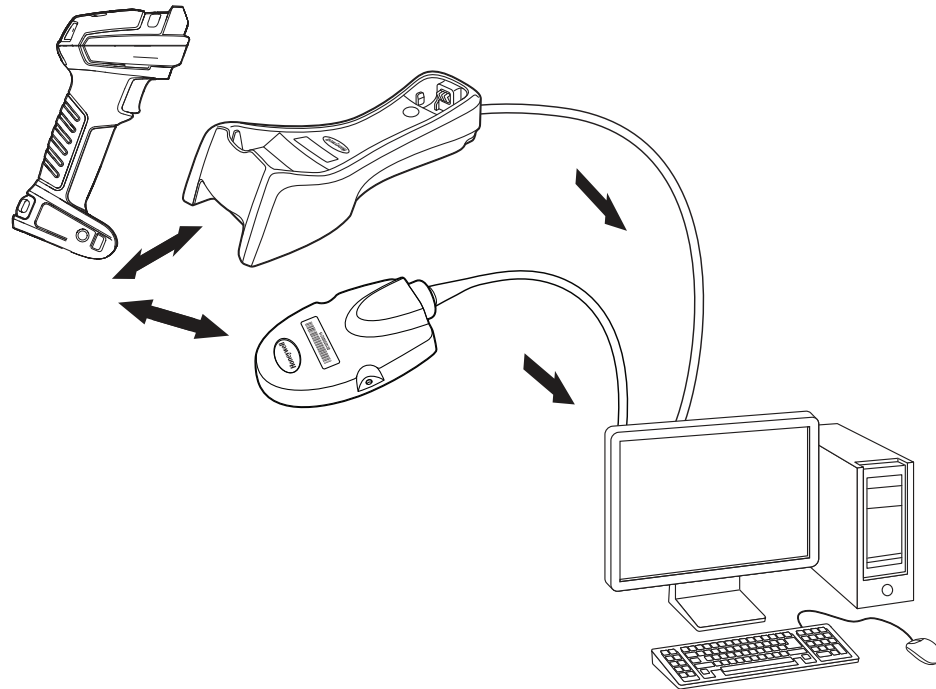

1. Scanner reads code and gets ACK from base or Access Point.
2. Base or Access Point sends data to host.

## Program the Scanner and Base or Access Point

When using the scanner and charge base or Access Point together as a system, menu parameters and configuration settings are stored in the charge base or Access Point. Therefore, when programming any menu configuration settings, the scanner must be linked to the intended charge base or Access Point.

**Note:** *This only applies when the scanner is linked to a charge base or Access Point. If the scanner is in a non-base mode, configuration settings are stored in the scanner.*

## RF (Radio Frequency) Module Operation

The cordless system uses a two-way Bluetooth™ radio to transmit and receive data between the scanner and the base or Access Point. Designed for point-to-point and multi-point-to-single point applications, the radio operates using a license free ISM band, which sends relatively small data packets at a fast data rate over a radio signal with randomly changing frequencies, makes the cordless system highly responsive to a wide variety of data collection applications and resistant to

noisy RF environments. The bases (Bluetooth Class 1 or Class 2) provide a communication range of 328 feet (100m) or 33 feet (10m) between the scanner and base or Access Point, depending on the environment. See [Flexible Power Management](#), page 57, for information about controlling this range.

## System Conditions

The components of the cordless system interact in specific ways as you associate a scanner to a base or Access Point, as you move a scanner out of range, bring a scanner back in range, or swap scanners between two cordless systems. The following information explains the cordless system operating conditions.

### Link Process

Once a scanner is placed into a cordless charge base, the scanner's charge status is checked, and software automatically detects the scanner and links it to the base depending on the selected link mode.

### Scanner Is Out of Range

The cordless scanner is in communication with its base or Access Point, even when it is not transmitting barcode data. Whenever the scanner can't communicate with the base or Access Point for a few seconds, it is out of range. If the scanner is out of range and you scan a barcode, the scanner issues an error tone indicating no communication with the base or Access Point. A cordless charge base can also sound an alarm. Refer to [Out-of-Range Alarm](#), page 54.

### Scanner Is Moved Back Into Range

The scanner relinks if the scanner or the base or Access Point have been reset, or the scanner comes back into range. If the scanner relinks, you will hear a single chirp when the relinking process (uploading of the parameter table) is complete. Refer to [Out-of-Range Alarm](#) on page 54 for further information.

### Out of Range and Back into Range with Batch Mode On

The scanner may store a number of symbols (approximately 500 U.P.C. symbols; others may vary) when it is out of range and then send them to the base or Access Point when back in range (see [Batch Mode](#) on page 58).

You will not hear a communication error tone in this mode, but you will hear a short buzz when you press the trigger if the radio communication is not working. Once the radio connection is made, the scanner produces a series of beeps while the data is being transferred to the base or Access Point.

# Page Button

When you press the page button on the base or Access Point, the scanners associated with that base or Access Point will begin beeping (3 short and 1 long beep). If you press the trigger on a scanner that is beeping in response, or press the page button on the base or Access Point a second time, all associated scanners will stop beeping. See [Page](#) on page 50 for further information about page button settings.

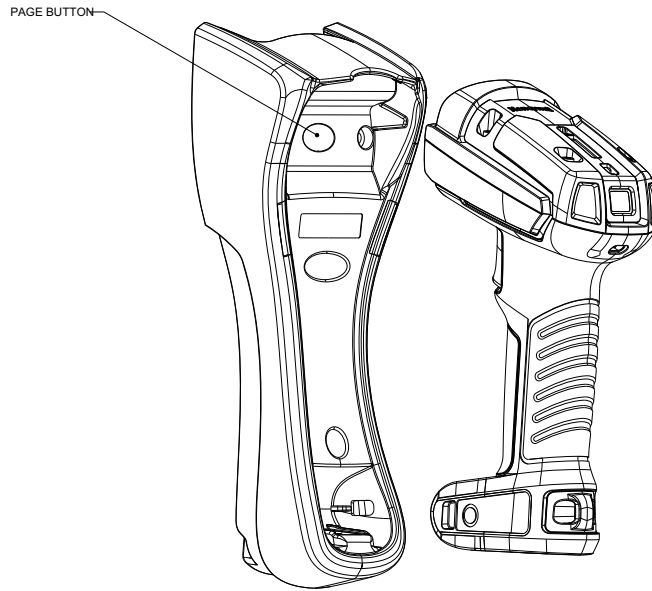

## Temporary Streaming Presentation Timeout

Set a timeout for the length of time the illumination remains on and searching for barcodes when using Temporary Streaming Presentation Mode. Set the length for the timeout by scanning one of the barcodes below. *Default = 10,000 ms (10 seconds).*



TRGTPM10000.  
\*10 Second Timeout



TRGTPM30000.  
30 Second Timeout

# Charge Information

The battery or charge pack is designed to charge while the scanner is positioned in the cordless base unit. Refer to [Scanner Communication and Scanning](#), page 46, for an interpretation of the Charge Status indicators. Refer to [Charge Only Mode](#) (page 52) if you need to charge a scanner without linking it to the base.

Place the scanner in the base that is connected to an appropriate power supply. Use only a Listed Limited Power Source (LPS) or Class 2 type power supply with output rated 5 to 5.2Vdc, 1A.

**Note:** *If you are powering the base through the interface cable (for example, a USB cable) and not using an external power supply plugged into the aux port, the current available for charging is reduced and charge times are increased.*

# Battery Information for the Granit XP 1991iSR and 1991iXR

Power is supplied to the scanner by a rechargeable battery that is integrated in the scanner handle. Batteries are shipped only partially charged. The battery should be charged for a minimum of 4 hours before initial use to ensure optimal performance.

## Battery Recommendations

- The battery is a lithium ion cell and can be used without a full charge, and can also be charged without fully discharging, without impacting the battery life. There is no need to perform any charge/discharge conditioning on this type of battery.
- Keep the base connected to power when the host is not in use.
- Replace a defective battery immediately since it could damage the scanner.
- Although your battery can be recharged many times, it will eventually be depleted. Replace it after the battery is unable to hold an adequate charge.
- If you are not sure if the battery or charger is working properly, send it to Honeywell International Inc. or an authorized service center for inspection. Refer to [Customer Support](#) on page xiii for additional information.



**Caution:** Use only Honeywell Li-ion battery packs, model number BAT-SCN05 (or legacy Granit BAT-SCN01/BAT-SCN01A), rated 3.7 Vdc, 7.4Whr in this device. Use of any non-Honeywell battery may result in damage not covered by the warranty.

## Safety Precautions for Lithium Batteries

- Do not place batteries in fire or heat the batteries.

- Do not store batteries near fire or other high temperature locations.
- Do not store or carry batteries together with metal objects.
- Do not expose batteries to water or allow the batteries to get wet.
- Do not connect (short) the positive and negative terminals, of the batteries, to each other with any metal object.
- Do not pierce, strike or step on batteries or subject batteries to strong impacts or shocks.
- Do not disassemble or modify batteries.



**Caution: Danger of explosion if batteries are incorrectly replaced. Dispose of used batteries according to the recycle program for batteries as directed by the governing agency for the country where the batteries are to be discarded.**

## Proper Disposal of the Battery

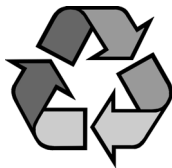

When the battery has reached the end of its useful life, the battery should be disposed of by a qualified recycling or hazardous materials handler. Do not incinerate the battery or dispose of the battery with general waste materials. You may send the scanner's battery to us (postage paid). The shipper is responsible for complying with all federal, state, and local laws and regulations related to the packing, labeling, manifesting, and shipping of spent batteries. Contact the Product Service Department ([page xiii](#)) for recycling or disposal information. Since you may find that your cost of returning the batteries is significant, it may be more cost effective to locate a local recycle/disposal company.

## Beeper and LED Sequences and Meaning

The scanner contains LEDs on the rear of the unit that indicate linking status, decoding state, and battery condition or instant charge pack condition. The base has LEDs on the top of the unit that indicate its power up, communication, and battery charge condition or instant charge pack condition.

For more information see, [About the Bluetooth Status and Battery Icons](#) on page 48

## Scanner Communication and Scanning

The following feedback is provided by the scanner and indicates communication and scanning status.

LED	Beeper	Cause
<b>Normal Operation</b>		
Green Flash	1 Beep	Successful communication or linking
Red, Blinking	Razz or Error Tone	Failed communication
<b>Menu Operation</b>		
Green Flash	2 Beeps	Successful menu change
Red, Blinking	Razz or Error Tone	Unsuccessful menu change

Querying battery volume by three times trigger in 2 seconds when the scanner is out of the base will activate the battery status icon.

**Note:** This functionality is only available with the smart battery pack.

Battery Icon LED	Red	Yellow	Green	Scanner Beep	Charge Level
Querying battery volume by three times trigger in 2 seconds when the scanner is out of the base will activate the battery status icon	3 sets of quick flashes in a row			No beep	<20%
		3 sets of quick flashes in a row		No beep	20%-40%
			3 sets of quick flashes in a row	No beep	>40%
When the scanner is in the base	2 sets of flashes then off 10 seconds			No beep	<20%
		2 sets of flashes then off 10 seconds		No beep	20%-40%
			2 sets of flashes then off 10 seconds	No beep	>40%
			Steady on	No beep	100%

Battery Icon LED	Red	Yellow	Green	Scanner Beep	Charge Level
When the scanner is out of the base and has been idle for 5 seconds		3 sets of flashes repeatedly every 3 seconds		No beep	<15%
	3 sets of flashes repeatedly every 3 seconds			No beep	<5%
	20 sets of rapid flashes			No beep	<2%

## Base/Access Point Communication and Scanning

The following feedback is provided by the base (red LED) or Access Point (blue LED) and indicates communication and scanning status.

LED	Communication Condition
Off	USB suspend
On continuously	Power on, system idle
Short blinks in multiple pulses. Occurs while transferring data to/from the RF module or the Host port.	Receiving data

## Base Power Communication Indicator

To display the power indicator on a base or an Access Point, scan the **Base Power Communication Indicator On** barcode. To turn off the power indicator, scan the **Off** barcode. *Default = On.*



**BASRED1.**

\* Base Power Communication Indicator On



**BASRED0.**

Base Power Communication Indicator Off

# About the Bluetooth Status and Battery Icons

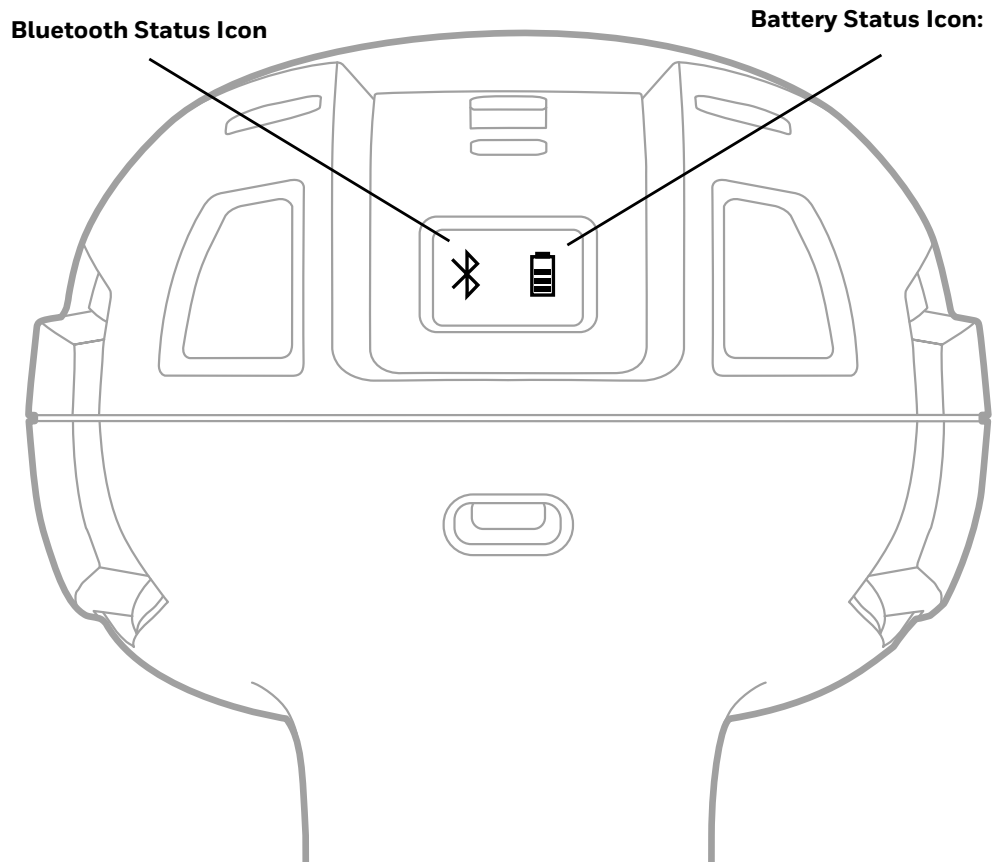

## About the Bluetooth Status Icon

The blue Bluetooth Icon LED has two behaviors flash and on. The icon will flash when linking to a device then will remain on, indicating the base and scanner are linked and stays on when the scanner is in base.

Once the scanner is removed from base, the blue LED stays on for four seconds then turns off.

**Note:** Link status can be checked by holding the trigger for three seconds, the BT LED will stay on for four seconds when BT is linked.

## About the Battery Status Icon

The Battery status icon displays the charged level of the battery. Low-power alerts are non-configurable. See the table below to learn more about low power indicators.

Scanner LED	Scanner Beep	Charge Level
Yellow 3 sets of flashes	No beep	<15%



Scanner LED	Scanner Beep	Charge Level
Red 3 sets of flashes, repeatedly every 3 seconds	No Beep	<5%
Red 20 sets of rapid flashes	No Beep	<2%

## Reset Scanner

Scanning this barcode reboots the scanner and causes it to relink with the base or Access Point.



## Base Charge Modes

When the base has both an external power supply (plugged into the auxiliary power port) and a host interface cable, it will draw its power from the external power supply. When the base does not have an external power supply, it draws its power from the interface cable. However, the scanner charges more slowly from a host interface cable than if auxiliary power were available. Using the following selections, you can specify whether the scanner is charged from power supplied via the host interface cable.

When **Base Charge Off** is selected, the scanner does not charge when the scanner is in the base cradle.

When **External or Interface Cable Power** is selected, the scanner charges from the base's external power supply, if there is one. If there is no external power supply to the base, the scanner charges from the interface cable.

When **External Power Only** is selected, the scanner only charges from the base's external power supply. If there is no external power supply, the scanner does not charge.

*Default = External or Interface Cable Power.*



# Page

## Page Mode

By default, the page button on the base or Access Point pages the scanners associated with that base or Access Point. If you want the page button on your base or Access Point to be disabled, scan the **Page Mode Off** barcode, below. When Page Mode is off, the base or Access Point will no longer page scanners when the button is pressed. The red LED on the base or blue LED on the Access Point will remain lit to indicate that page mode is off. (This light will go out when the button is pressed, then back on when it's released.) *Default = Page Mode On.*



BEPPGE1.  
\* Page Mode On



BEPPGE0.  
Page Mode Off

## Page Pitch

When you press the page button on the base or Access Point, the scanners associated with that base or Access Point will begin beeping (see [Page Button](#) on page 43). You can set the pitch of the paging beep for each scanner by scanning one of the following barcodes. *Default = Low.*



BEPPFQ1000.  
\* Low (1000 Hz)



BEPPFQ3250.  
Medium (3250 Hz)



BEPPFQ4200.  
High (4200 Hz)

# Error Indicators

## Beeper Pitch - Base Error

The base can be configured to beep at a particular pitch when an error occurs, such as transmission problems to a host system. The beeper pitch codes modify the pitch (frequency) of the error tone the base emits when there is an error. *Default = Low.*



BASFQ2250.

\* Low/Razz (250 Hz)



BASFQ23250.

Medium (3250 Hz)



BASFQ24200.

High (4200 Hz)

## Number of Beeps - Base Error

The number of beeps and LED flashes emitted by the base for an error condition can be programmed from 1 - 9. For example, if you program this option to have five error beeps, there will be five error beeps and five LED flashes in response to an error. To change the number of error beeps, scan the barcode below and then scan a digit (1-9) from the [Programming Chart](#), beginning on page 289, then **Save**. *Default = 1.*



BASERR.

Number of Base Error Beeps/LED Flashes

## Scanner Report

Scan the barcode below to generate a report for the connected scanners. The report indicates the port, work group, scanner name, and address. To assign a name to your scanner, refer to [Menu Command Syntax](#), page 225.



RPTSCN.

Scanner Report

# Scanner Address

Scan the barcode below to determine the address of the scanner you are using.



BT\_LDA.

**Scanner Address**

# Base or Access Point Address

Scan the barcode below to determine the address of the base or Access Point you are using.



BASLDA.

**Base Address**

# Scanner Modes

Your scanner is capable of working in single scanner mode, multiple scanner mode, or with Bluetooth devices other than a charge base or Access Point.

# Charge Only Mode

There may be times when you want to charge your scanner, but not link to the base. For example, if a scanner is linked to an Access Point or other Bluetooth device and you need to charge the scanner, but want to retain your existing link.

In order to program the base for Charge Only Mode, you must link a scanner to it. Once the scanner is linked to the base, scan the **Charge Only Mode** barcode. Any subsequent scanners placed in that base will charge without linking to it. The scanner used to program the base remains linked to the base. To unlink this scanner, scan [Unlink Scanner](#) on page 54.



BASLNK0.

**Charge Only Mode**

**Note:** *When in Charge Only Mode, the scanner periodically wakes up and beeps. See [Power Up Beeper](#) on page 77 to change this setting.*

## Charge and Link Mode

If you want to charge a scanner and link to the base, use Charge and Link Mode. If the base is programmed for Charge Only Mode, you must link a scanner to it first in order to program it for Charge and Link Mode. Scan the linking barcode on the base to link the scanner, then scan **Charge and Link Mode**. *Default = Charge and Link Mode.*



## Linked Modes

Locked Link Mode and Open Link Mode are the link modes that accommodate different applications. Scan the appropriate barcodes included in the Open Link and Locked Link Mode explanations that follow to switch from one mode to another. *Default = Open Link Mode.*

### Locked Link Mode - Single Scanner

If you link a scanner to a base or an Access Point using the Locked Link Mode, other scanners are blocked from being linked if they are inadvertently placed into the base, or if the Access Point linking barcode is scanned. If you do place a different scanner into a base, it will charge the scanner, but the scanner will not be linked.



To use a different scanner, you need to unlink the original scanner by scanning the **Unlink Scanner** barcode. (See [Unlink the Scanner](#), page 54.)

### Open Link Mode - Single Scanner

When newly shipped or defaulted to factory settings, a scanner is not linked to a base or an Access Point. A link is established when the scanner is placed into a base, or an Access Point linking barcode is scanned. When in Open Link Mode, a new link is established when a new scanner is placed in the base, or you scan an Access Point linking barcode. Each time a scanner is placed into a base or scans an Access Point linking barcode, the scanner becomes linked to the base or Access point and the old scanner is unlinked.



## Unlink the Scanner

If a base or an Access Point has a scanner linked to it, that scanner must be unlinked before a new scanner can be linked. Once the previous scanner is unlinked, it will no longer communicate with the base or Access Point. To unlink the scanner from a base or an Access Point, scan the **Unlink Scanner** barcode below.



## Override Locked Scanner

If you need to replace a broken or lost scanner that is linked to a base or an Access Point, scan the **Override Locked Scanner** barcode below with a new scanner and place that scanner in the base, or scan the Access Point linking barcode. The locked link will be overridden; the broken or lost scanner's link with the base or Access Point will be removed, and the new scanner will be linked.



## Out-of-Range Alarm

If your scanner is out range of the base, an alarm sounds from both your base and scanner. If your scanner is out range of an Access Point, an alarm sounds from just the scanner. The alarm stops when the scanner is moved closer to the base or Access Point, when the base or Access Point connects to another scanner, or when the alarm duration expires. To activate the alarm options for the scanner or the base and to set the alarm duration, scan the appropriate barcode below and then set the time-out duration (from 0-3000 seconds) by scanning digits on the [Programming Chart](#), beginning on page 289, then **Save**. *Default = 0 sec (no alarm).*



**Note:** *The Access Point does not have a base alarm.*



**Note:** *If you are out of range when you scan a barcode, you will receive an error tone even if you do not have the alarm set. You receive the error tone because the data could not be sent to the base or Access Point or the host.*

## Alarm Sound Type

You may change the alarm type for the scanner or base by scanning the appropriate barcode below and then scanning a digit (0-7) barcode from the [Programming Chart](#), beginning on page 289, then **Save**. *Default = 0.*

The sounds are as follows:

Setting	Sound
0	3 long beeps, medium pitch
1	3 long beeps, high pitch
2	4 short beeps, medium pitch
3	4 short beeps, high pitch
4	single chirps, medium pitch
5	2 chirps, then 1 chirp, medium pitch
6	single chirps, high pitch
7	2 chirps, then 1 chirp, high pitch



BASORW.

Base Alarm Type



BT\_ORW.

Scanner Alarm Type

## Scanner Power Time-Out Timer

When there is no activity within a specified time period, the scanner enters low power mode. Scan the appropriate scanner power time-out barcode to change the time-out duration (in seconds).

**Note:** Scanning zero (0) is the equivalent of setting no time-out.

If there are no trigger pulls during the timer interval, the scanner goes into power down mode. Whenever the trigger is enabled, the timer is reset. The scanner will not go into power down mode when it is in the base and charging. *Default = 3600 seconds.*



BT\_LPT0.

0 seconds



BT\_LPT200.

200 seconds



BT\_LPT400.

400 seconds



BT\_LPT900.

900 seconds



BT\_LPT3600.

\* 3600 seconds



BT\_LPT7200.

7200 seconds

**Note:** *When the scanner is in power down mode, press the trigger to power the unit back up. There will be a set of power up beeps and a delay of up to a few seconds for the radio to join. The scanner will then be ready to use.*



# Flexible Power Management

If you are experiencing network performance issues, and suspect the scanner is interfering with other devices, you can turn down the power output of the scanner. This reduces the range between the scanner and a base or an Access Point as shown in the following illustration:

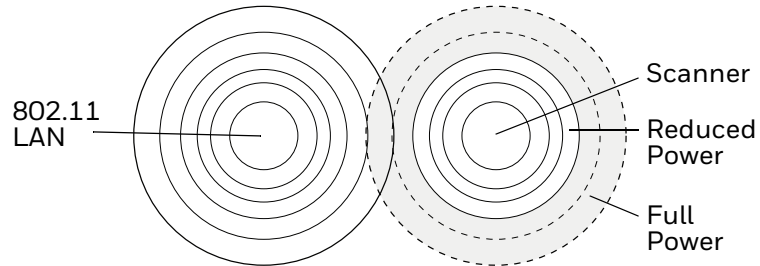

## Granit XP 1990i and 1991i

Scan one of the barcodes below to set the scanner's power output to **Full Power** (100%), **Medium Power** (35%), **Medium Low Power** (5%), or **Low Power** (1%).  
*Default = Full Power.*

For Bluetooth Class 1 operation, use Full Power.

For Bluetooth Class 2 operation, use Medium Power or lower.

For BLE operation, use Medium Power.



BT\_TXP100.  
\* Full Power



BT\_TXP35.  
Medium Power



BT\_TXP5.  
Medium Low Power



BT\_TXP1.  
Low Power

# Batch Mode

Batch mode is used to store barcode data when a scanner is out of range of its base or Access Point, or when performing inventory. The data is transmitted to the base or Access Point once the scanner is back in range or when the records are manually transmitted.

**Note:** *Batch Mode is only supported by the Honeywell Charge and Communication Base (CCB) and Honeywell Access Point (AP). Batch mode has limitations when using multiple scanners to one base or Access Point. If a cordless system is being used in “multiple link mode,” where up to 3 scanners are to be connected to one base or Access Point, some accumulated or batched scans could be lost if scanners are constantly being moved in and out of range.*

**Automatic Batch Mode** stores barcode data when the scanner is out of range of the base or Access Point. The data is automatically transmitted to the base or Access Point once the scanner is back in range. When the scanner’s buffer space is full, any barcodes scanned generate an error tone. In order to scan barcodes again, the scanner must be moved back into range of the base or Access Point so data can be transmitted.

**Inventory Batch Mode** stores barcode data, whether or not you are in range of the base or Access Point. To transmit the stored data to the base or Access Point, either place the scanner in the base, or scan [Transmit Inventory Records](#) (page 63). When the scanner’s buffer space is full, any barcodes scanned generate an error tone. In order to scan barcodes again, the data must be transmitted to the base or Access Point. Once the data is transmitted, it is cleared in the scanner.

**Persistent Batch Mode** is the same as Inventory Batch Mode, except that once the data is transmitted to the base or Access Point, it is retained in the scanner. If you want to transmit more than once, you can do so using this mode. In order to clear the scanner’s buffer, you must scan [Clear All Codes](#) (see page 62).

*Default = Batch Mode Off.*



BATENA0.

\* Batch Mode Off



BATENA1.

Automatic Batch Mode



BATENA2.

Inventory Batch Mode



BATENA3.

Persistent Batch Mode

## Batch Mode Beep

When scanning in [Inventory Batch Mode](#) (page 58), the scanner beeps every time a barcode is scanned. When Batch Mode Beep is **On**, you will also hear a click when each barcode is sent to the host. If you do not want to hear these clicks, scan **Batch Mode Beep Off**. *Default = Batch Mode Beep On.*



BATBEP0.

**Batch Mode Beep Off**



BATBEP1.

**\* Batch Mode Beep On**

## Batch Mode Storage

When a scanner is storing data during a Batch Mode process, you can select whether the data is stored in Flash memory or in RAM.

**Flash Storage:** The scanner writes any untransmitted data to flash memory prior to powering down. The data will still be there when the scanner powers back up. However, the scanner will power down, even with untransmitted data, if it reaches a power down timeout or if the battery or charge pack power is very low.

**RAM Storage:** The scanner will not power down while it contains data that has not been transmitted to the base or Access Point, even if it reaches a power down timeout. However, if the scanner runs out of power, it will power down and the data will be lost.

*Default = Flash Storage.*



BATNVS1.

**\* Flash Storage**



BATNVS0.

**RAM Storage**

## Batch Mode Quantity

When in Batch Mode, you may wish to transmit the number of multiple barcodes scanned, rather than a single barcode multiple times. For example, if you scan three barcodes called XYZ with **Batch Mode Quantity Off**, when you transmit your data it will appear as XYZ three times. Using **Batch Mode Quantity On** and the Quantity Codes ([page 61](#)), you could output your data as “XYZ, 00003” instead.

**Note:** *If you wish to format your output, for example, place a CR or tab between the barcode data and the quantity, refer to [Data Format](#) beginning on page 119.*

*Default = Batch Mode Quantity Off.*



BATQTY0.

\* Batch Mode Quantity Off



BATQTY1.

Batch Mode Quantity On

## Enter Quantities

Quantity Codes ([page 61](#)) allow you to enter a quantity for the last item scanned, up to 9999 (default = 1). Quantity digits are shifted from right to left, so if a fifth digit is scanned, the first digit scanned is discarded and the second, third and fourth digits are moved to the left to accommodate the new digit.

For example, if the Quantity 5 barcode is scanned after the quantity has been set to 1234, then the 1 is dropped, the quantity will be 2345.

**Example:** Add a quantity of 5 for the last item scanned.

1. Scan the item's barcode.
2. Scan the quantity **5** barcode.

**Example:** Add a quantity of 1,500 for the last item scanned.

1. Scan the item's barcode.
2. Scan the quantity **1** barcode.
3. Scan the quantity **5** barcode.
4. Scan the quantity **0** barcode.
5. Scan the quantity **0** barcode.

**Example:** Change a quantity of 103 to 10.

To correct an incorrect quantity, scan the quantity 0 barcode to replace the incorrect digits, then scan the correct quantity barcodes.

1. Scan the quantity **0** barcode to change the quantity to 1030.
2. Scan the quantity **0** barcode to change the quantity to 0300.
3. Scan the quantity **1** barcode to change the quantity to 3001.
4. Scan the quantity **0** barcode to change the quantity to 0010.

*Default = 1.*

## Quantity Codes

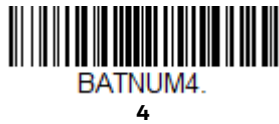
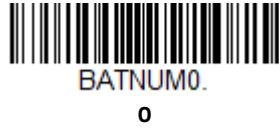

## Batch Mode Output Order

When batch data is transmitted, select whether you want that data sent as **FIFO** (first-in first-out), or **LIFO** (last-in first-out). *Default = Batch Mode FIFO.*



BATLIF0.

\* Batch Mode FIFO



BATLIF1.

Batch Mode LIFO

## Total Records

If you wish to output the total number of barcodes scanned when in Batch Mode, scan **Total Records**.



BATNRC.

Total Records

## Delete Last Code

If you want to delete the last barcode scanned when in Batch Mode, scan **Delete Last Code**.



BATUND.

Delete Last Code

## Clear All Codes

If you want to clear the scanner's buffer of all data accumulated in Batch Mode, scan **Clear All Codes**.



BATCLR.

Clear All Codes

## Transmit Records to Host

If you are operating in Inventory Batch Mode (see [Inventory Batch Mode](#) on page 58), you must scan the following barcode to transmit all the stored data to the host system.



BAT\_TX.

Transmit Inventory Records

## Batch Mode Transmit Delay

Sometimes when accumulated scans are sent to the host system, the transmission of those scans is too fast for the application to process. To program a transmit delay between accumulated scans, scan one of the following delays. *Default = Off.*

**Note:** *In most cases, a short (250 ms (milliseconds)) delay is ideal, however, longer delays may be programmed. Contact Technical Support ([page xiii](#)) for additional information.*



BATDLY0.

\* Batch Mode Transmit Delay Off  
(No Delay)



BATDLY250.

Batch Mode Transmit Delay Short  
(250 ms)



BATDLY500.

Batch Mode Transmit Delay Medium  
(500 ms)



BATDLY1000.

Batch Mode Transmit Delay Long  
(1000 ms)

## Multiple Scanner Operation

**Note:** *Multiple Scanner Operation Mode allows you to link up to 3 scanners to one base or Access Point. You cannot join an 4th scanner until you unlink one of the 3 scanners or take a scanner out of range.*

To put the scanner in multiple scanner mode, scan the barcode below. Once you scan this barcode, the scanner is unlinked from the base or Access Point and must either be placed into the base, or you must scan the Access Point linking barcode in order to relink.



## Scanner Name

You may assign a name to each scanner you are using for identification purposes. For example, you may want to have a unique identifier for a scanner that is receiving imaging commands sent from the base or Access Point.

The default name is in the format “ScannerName\_Model\_SN\_XXXXXXXXXX” If you have more than one scanner linked to a base, and they all have the same name, the first scanner linked to the base receives commands. When renaming a series of scanners with identical names, unlink all except one of the scanners from the base.

Perform the rename operation using either the barcodes on [page 65](#), or by sending the serial command **:ScannerName:BT\_NAMNewName.** where *ScannerName* is the current name of the scanner, and *NewName* is the new name for the scanner. If you wish to change the names of additional scanners, link them one at a time and repeat the **:ScannerName:BT\_NAMNewName.** command for each scanner.

To rename scanners with sequential numeric names, scan the barcodes below. Scan the **Reset** code after each name change and wait for the scanner to relink to the base or Access Point before scanning a barcode to rename the next scanner.

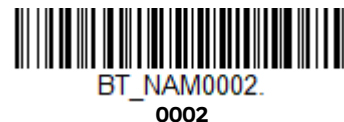



You may also scan the **Scanner Name** barcode below and scan a number for the scanner name. For example, if you wanted to name the linked scanner “312,” you would scan the barcode below, scan the **3**, **1**, and **2** barcodes on the [Programming Chart](#), beginning on page 289, then **Save**. Scan the **Reset** barcode and wait for the scanner to relink to the base.

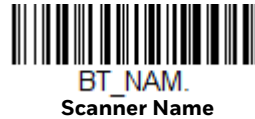

## Application Work Groups

Your cordless system can have up to 3 scanners linked to one base or Access Point. You can also have up to 3 work groups. If you want to have all of the scanners’ settings programmed alike, you don’t need to use more than one work group. If you want each scanner to have unique settings (e.g., beeper volume, prefix/suffix, data formatter), then you may program each scanner to its own unique work group and may program each scanner independently. For example, you might want to have multiple work groups in a retail/warehouse application where you need to have different data appended to barcodes used in the warehouse area versus the retail area. You could assign all the scanners in the retail area to one work group and those in the warehouse to another. Consequently, any desired changes to either the retail or warehouse area would apply to all scanners in that particular work group. Honeywell’s online configuration tool, EZConfig-Scanning ([page 222](#)), makes it easy for you to program your system for use with multiple scanners and multiple work groups.

The scanner keeps a copy of the menu settings it is using. Whenever the scanner is connected or reconnected to a base or an Access Point, the scanner is updated with the latest settings from the base or Access Point for its work group. The scanner also receives menu setting changes processed by the base or Access Point. If a scanner is removed from a base or an Access Point and placed into another base or linked to another Access Point, it will be updated with the new base/Access Point settings for whatever work group to which that the scanner was previously assigned. For example, if the scanner was in work group 1 linked to the first base, it will be placed in work group 1 in the second base with the associated settings.

## Application Work Group Selection

This programming selection allows you to assign a scanner to a work group by scanning the barcode below. You may then program the settings (e.g., beeper volume, prefix/suffix, data formatter) that your application requires. *Default = Group 0.*





## Reset the Factory Defaults: All Application Work Groups

The following barcode defaults all of the work groups to the factory default settings.



To see what the factory default settings are, refer to the table of [Menu Commands](#), beginning on page 230. The standard product default settings for each of the commands are indicated by an asterisk (\*).

**Note:** *Scanning this barcode also causes both the scanner and the base or Access Point to perform a reset and become unlinked. The scanner must be placed in the base, or the Access Point linking barcode must be scanned to re-establish the link. Refer to [Scanner Modes](#), page 52 for additional information.*

*If your scanner is in multiple scanner mode, you will hear up to 30 seconds of beeping while all scanners are relinked to the base or Access Point and the settings are changed.*

# Reset the Custom Defaults: All Application Work Groups

If you want the custom default settings restored to all of the work groups, scan the **Custom Product Default Settings** barcode below. (If there are no custom defaults, it will reset the work groups to the factory defaults.) See [Set Custom Defaults](#) on page 10 for further information about custom defaults.



**Note:** Scanning this barcode also causes both the scanner and the base or Access Point to perform a reset and become unlinked. The scanner must be placed in its base, or the Access Point linking barcode must be scanned to re-establish the link. Refer to [Scanner Modes](#), page 52 for additional information.

*If your scanner is in multiple scanner mode, you will hear up to 30 seconds of beeping while all scanners are relinked to the base or Access Point and the settings are changed.*

## Use the Scanner with Bluetooth Devices

The scanner can be used either with the charge base or with other Bluetooth devices. Those devices include personal computers, laptops, PDAs, and Honeywell mobility systems devices.

## Bluetooth Secure Simple Pairing (SSP)

Secure Simple Pairing (SSP) allows you to connect simply and securely to other Bluetooth devices without having to enter a PIN code (as described in [Connect with Bluetooth Device Directly](#) procedure). SSP is only available when using Bluetooth version 2.1 or higher. When SSP is on, no PIN is required for pairing. Turn SSP off if you are connecting to a Bluetooth device that is not using a compatible Bluetooth version. *Default = Bluetooth SSP On.*



## Connect with Bluetooth Device Directly

Your scanner can be paired with Bluetooth-capable devices, such as personal computers, laptops, and tablets, so that scanned data appears on your device screen as though it was entered on the keyboard. In order to pair with the Bluetooth device:

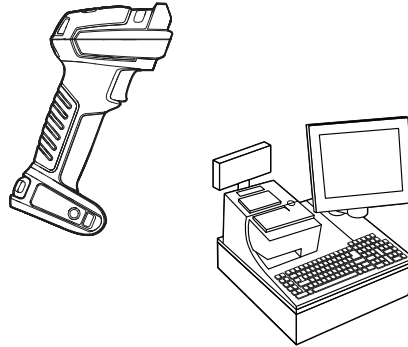

1. Scan the appropriate **Bluetooth HID Keyboard Connect** barcode below.



2. Set your personal computer, laptop or tablet so it searches for other Bluetooth devices. (Refer to your device's User Guide for pairing instructions.)
3. Select the scanner name on your device. Some devices will automatically pair with the scanner. If your device pairs automatically with the scanner, it displays a successful pairing message and you do not need to continue to the next step.
4. If your device does not automatically pair with the scanner, a PIN is displayed. This PIN must be scanned within 60 seconds. Quickly scan **Bluetooth PIN Code** below, then scan the numeric barcode(s) for the PIN code from the chart below, then scan **Save**.





K1K

1



K3K

3



K5K

5



K7K

7



K9K

9



K2K

2



K4K

4



K6K

6



K8K

8



MNUSAV.

Save

## Virtual Keyboard

Once your scanner has been connected directly to an iPad, smart phone, or laptop, you can toggle the virtual keyboard on your device with a quick double pull of the scanner trigger.



## Bluetooth HID Keyboard Disconnect

If your scanner has been connected directly to an iPad, smart phone, or laptop, you must disconnect it in order to once again communicate with the base or Access Point. Scan the **Bluetooth HID Keyboard Disconnect** barcode to unlink the scanner from the currently linked host. Scan the linking barcode on the base or Access Point to relink the scanner.



## Pair with Bluetooth Low Energy (BLE) Devices

Use the following codes to connect to Bluetooth low energy devices. Scan **HID BLE Connect** to connect the scanner to Bluetooth Low Energy HID devices. Scan **Serial BLE Connect** to establish two-way communication between the scanner and Bluetooth Low Energy serial devices.



## Bluetooth Serial Port - PCs/Laptops

Scanning the **Non-Base BT Connection** barcode below unlinks your scanner and puts it into a discoverable state. Once the scanner searches for and connects with a Bluetooth host, the scanner stores the connection to the host device address and switches virtual COM ports. This allows the scanner to automatically relink to the host if the connection is lost.



BT\_TRM0;BT\_DNG5.

**Non-Base BT Connection**

## PDA/Mobility Systems Devices

You may also use the scanner with a PDA or a Honeywell Mobility Systems device. Scan the barcode below and follow the instructions supplied with your Bluetooth device to locate the scanner, and connect with it.



BT\_TRM0;BT\_DNG1.

**BT Connection - PDA/Mobility Systems Device**

## Change the Scanner's Bluetooth PIN Code

Some devices require a PIN code as part of the Bluetooth security features. Your scanner's default PIN is **1234**, which you may need to enter the first time you connect to your PDA or PC. The PIN code must be between 1 and 16 characters. To change the PIN, scan the barcode below and then scan the appropriate numeric barcodes from the [Programming Chart](#), beginning on page 289, then **Save**.



BT\_PIN.

**Bluetooth PIN**

## Minimize Bluetooth/ISM Band Network Activity

The settings described below can help you customize the relinking behavior of the cordless area-imaging system to obtain the best compromise between convenience and low interference.

**Note:** *ISM band refers to the 2.4 to 2.48 GHz frequency band used by wireless networks, cordless phones, and Bluetooth.*

## Auto Reconnect Mode

Auto Reconnect controls whether or not the scanner automatically begins the relink process when a loss of connection is detected. When the **Auto Reconnect On** barcode is scanned, the scanner begins the relink process immediately, without user intervention. *Default = Auto Reconnect On.*

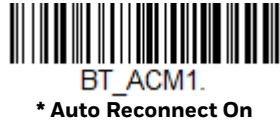

The table below shows the results of the Auto Reconnect On and Off settings:

Event	Auto Reconnect On	Auto Reconnect Off
Scanner out of range	Relink occurs automatically. If maximum number of link attempts is unsuccessful, then the scanner must be relinked by either pulling the trigger, placing the scanner in the base, or scanning the Access Point linking barcode. (See <a href="#">Maximum Link Attempts</a> on page 72.)	The scanner is relinked by pulling the trigger, or scanning the Access Point linking barcode.
Base or Access point reset (firmware upgrade or power cycle)	Scanner behaves as if out of range.	No attempt to relink made while base or Access Point is powered off. Trigger must be pulled to initiate relinking.
Scanner power down due to Power Time-Out Timer setting	Trigger must be pulled, Access Point linking barcode must be scanned, or the scanner must be placed in the base unit to relink. (Note: Scanner re-links on power up, but powers on due to one of the above actions.)	
Scanner reset due to firmware upgrade	Relink occurs automatically.	
Scanner reset due to battery or charge pack change	Relink occurs automatically.	
Scanner placed in different base unit	Relink to new base occurs automatically.	

## Maximum Link Attempts

The Maximum Link Attempts setting controls the number of times the scanner tries to form a connection with a base or an Access Point. During the connection setup process, the scanner transmits in order to search for and connect to a base or an Access Point. In order to prevent continuous transmissions that could interfere with other users of the ISM band, the number of attempts to connect is limited



by this setting. After the maximum number of attempts is reached, the scanner will not attempt to reconnect to a base or an Access Point. Pressing the trigger, scanning an Access Point linking barcode, or placing the scanner in the cradle resets the attempt count and the scanner will again try to link.

Scan the **Maximum Link Attempts** barcode, then scan the number of attempts for the setting (from 0-100) from the [Programming Chart](#), beginning on page 289, then **Save**. *Default = 0.*



**Note:** *When Auto Reconnect Mode is On, setting Maximum Link Attempts to zero will cause the scanner to try to link until the Power Time-Out Timer setting expires. When Auto Reconnect Mode is Off, setting Maximum Link Attempts to zero will cause the scanner to only attempt linking one time after a trigger press.*

## Relink Time-Out

Relink Time-Out controls the idle time between relink attempts. An attempt to link a scanner to a base or an Access Point typically lasts up to 5 seconds. This is the time when the scanner is actually attempting a contact. Relink Time-Out controls the amount of time, in seconds, that elapses between the end of one connection attempt and the start of the next.

**Note:** *The length of time for an attempt depends on the number of scanners connected to a base unit or Access Point. An extra 7 seconds may be required when a connection is successful.*

Scan the **Relink Time-Out** barcode, then scan the number of seconds for the setting (from 1-100) from the [Programming Chart](#), beginning on page 289, then **Save**. *Default = 3 seconds.*



## Bluetooth/ISM Network Activity Examples

### Default values

When the scanner goes out of range, the scanner repeatedly attempts to connect to the base unit or Access Point. Each attempt consists of approximately 5 seconds of active time followed by 3 seconds of idle time. After one hour, the scanner powers off and batch mode data is lost.

**Example:** Maximum Link Attempts set to 15  
Other values at default setting

When the scanner goes out of range, 15 attempts are made to link to the base unit or Access Point. Each attempt consists of approximately 5 seconds of active time followed by 3 seconds of idle time. After 15 cycles (8\*15 =120), or about 2 minutes, the scanner stops trying to connect to the base or Access Point, but retains any barcodes that may have been saved in batch mode. After one hour, the scanner powers off and batch mode data is lost.

**Example:** Auto Reconnect Mode set to 0  
Maximum Link Attempts set to 15  
Other values at default setting

When the scanner goes out of range, no action is taken to relink. When the trigger is pulled, 15 attempts are made to link to the base or Access Point. Each attempt consists of approximately 5 seconds of active time followed by 3 seconds of idle time. After 15 cycles (8\*15 =120), or about 2 minutes, the scanner stops trying to connect to the base or Access Point, but retains any barcodes that may have been saved in batch mode. After one hour, the scanner powers off and batch mode data is lost. Refer to [Auto Reconnect Mode](#), page 72, to review other events that can start the relink process.

**Example:** Auto Reconnect Mode set to 1  
Maximum Link Attempts set to 0  
Relink Time-Out set to 10  
Scanner Power Time-Out Timer set to 1800

**Note:** See [Scanner Power Time-Out Timer](#) on page 55.

The scanner attempts to connect to the base or Access Point every 15 seconds, measured from one attempt start to the next attempt start. After one half hour, the scanner powers off.

## Host Acknowledgment

Some applications require that the host terminal (or server) validate incoming barcode data (database look-up) and provide acknowledgment to the scanner whether or not to proceed. In Host ACK Mode, the scanner waits for this acknowledgment after each scan. Visual and audible acknowledgments provide valuable feedback to the scan operator. The Host ACK functionality is controlled via a number of pre-defined escape commands that are sent to the scanner to make it behave in different ways.

**Note:** *System performance degrades when using Host ACK at rates lower than 9600 baud.*

The following criteria must be met for the Host ACK to work correctly:

- The cordless system must be configured for Host Port RS232 (terminal ID = 000 or USB COM Emulation (terminal ID = 130).
- RTS/CTS is defaulted off. You must enable it if the host system requires it.
- Host ACK must be set to **On** ([page 76](#)).

- A comma must be used as a terminator.
- The host terminal software must be capable of interpreting the barcode data, make decisions based on the data content, and send out appropriate escape commands to the scanner.

Escape commands are addressed to the scanner via “Application Work Groups.” Once a command is sent, all scanners in a group respond to that command. Because of this, it is recommended that each scanner is assigned to its own group in Host ACK mode.

The commands to which the scanner responds are listed on [page 76](#). The **[ESC]** is a **1B** in hex. A typical command string is **y [ESC] x**, where “y” is the application work group number, “[ESC] x” is the escape command, and the comma is the terminator, which is required. (When “y” is not specified, the command is sent to the default Application Work Group 0.)

**Example:** Commands may be strung together to create custom response sequences. An example of a command string is listed below.

**[ESC]4,[ESC]5,[ESC]6,**

The above example will make a scanner that is in application work group zero beep low, then medium, then high.

**Example:** A good read beep is required for any item on file, but a razz or error tone is required if the item is not on file. In this case,

**[ESC]7,** is sent from the host to the scanner for an on-file product

**[ESC]8,[ESC]8,** is sent from the host to the scanner for a not-on-file product

When a barcode is scanned, the scanner enters a timeout period until either the host ACK sequence is received, or the timeout expires (in 10 seconds, by default).

Once Host ACK is enabled, the system works as follows when a barcode is scanned:

- The scanner reads the code and sends data to the base or Access Point to transmit to the host system. No audible or visual indication is emitted until the scanner receives an escape command. The scanner read illumination goes out when there’s a successful read.
- Scanner operation is suspended until 1) a valid escape string is received from the host system or 2) the scanner times out.
- Once condition 1 or 2 above has been met, the scanner is ready to scan again, and the process repeats.

A time-out occurs if the scanner does not receive a valid escape command within 10 seconds. A time-out is indicated by an error tone. If a time-out occurs, the operator should check the host system to understand why a response to the scanner was not received.

## Host ACK On/Off

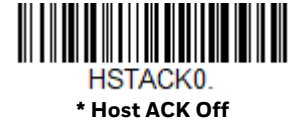

## Host ACK Timeout

You can set a timeout for the length of time the scanner waits for a valid escape command when using Host Acknowledgment Mode. Set the length (in seconds) for a timeout by scanning the following barcode, then setting the timeout (from 1-90 seconds) by scanning digits from the [Programming Chart](#), beginning on page 289, then **Save**. *Default = 10.*



## Host ACK Responses

Command	Action
[ESC] a,	Double beeps to indicate a successful menu change was made.
[ESC] b,	Razz or error tone to indicate a menu change was unsuccessful.
[ESC] 1,	The green LED illuminates for 135 milliseconds followed by a pause.
[ESC] 2,	The green LED illuminates for 2 seconds followed by a pause.
[ESC] 3,	The green LED illuminates for 5 seconds followed by a pause.
[ESC] 4,	Emits a beep at a low pitch.
[ESC] 5,	Emits a beep at a medium pitch.
[ESC] 6,	Emits a beep at a high pitch.
[ESC] 7,	Beeps to indicate a successful decode and communication to host.
[ESC] 8,[ESC] 8,	Razz or error tone to indicate a decode/communication to host was unsuccessful.

## Power Up Beeper

The scanner can be programmed to beep when it's powered up. If you are using a cordless system, the base can also be programmed to beep when it is powered up. Scan the **Off** barcode(s) if you don't want a power up beep. *Default = Power Up Beeper On - Scanner.*



BEPPWR0.

Power Up Beeper Off -  
Scanner



BASPWR0.

Power Up Beeper Off -  
Cordless Base



BEPPWR1.

\* Power Up Beeper On -  
Scanner



BASPWR1.

Power Up Beeper On -  
Cordless Base

# Beep on BEL Character

You may wish to force the scanner to beep upon a command sent from the host. If you scan the **Beep on BEL On** barcode below, the scanner will beep every time a BEL character is received from the host. *Default = Beep on BEL Off.*



# Trigger Click

To hear an audible click every time the scanner trigger is pressed, scan the **Trigger Click On** barcode below. Scan the **Trigger Click Off** code if you don't wish to hear the click. (This feature has no effect on serial or automatic triggering.) *Default = Trigger Click Off.*



# Good Read and Error Indicators

## Beeper – Good Read

The beeper may be programmed **On** or **Off** in response to a good read. Turning this option off only turns off the beeper response to a good read indication. All error and menu beeps are still audible. *Default = Beeper - Good Read On.*



## Beeper Volume – Good Read

The beeper volume codes modify the volume of the beep the scanner emits on a good read. *Default = High for Granit XP.*



BEPLVL1.

Low



BEPLVL2.

Medium



BEPLVL3.

\* High



BEPLVL0.

Off

## Beeper Pitch – Good Read

The beeper pitch codes modify the pitch (frequency) of the beep the scanner emits on a good read. *Default = Medium.*



BEPFQ11600.

Low (1600 Hz)



BEPFQ12700.

\* Medium (2700 Hz)



BEPFQ14200.

High (4200 Hz)

## Vibrate – Good Read

The scanner vibrates once when a barcode is successfully read, and twice when a programming barcode is successfully read. When a programming barcode is unsuccessful, the scanner emits one long vibration (2 times the Vibrate Duration length). Scan **Vibrate – Good Read Off** to keep the scanner from vibrating. *Default = Vibrate – Good Read On.*



## Vibrate Duration

If you want to set the length for the good read vibration, scan the barcode below, then set the duration (from 100 - 2,000 milliseconds) by scanning digits from the [Programming Chart](#), beginning on page 289, then **Save**. *Default = 100 ms.*



## Beeper Pitch – Error

The beeper pitch codes modify the pitch (frequency) of the sound the scanner emits when there is a bad read or error. *Default = Razz.*





## Beeper Duration – Good Read

The beeper duration codes modify the length of the beep the scanner emits on a good read. *Default = Normal.*



BEPBIP0.  
\* Normal Beep



BEPBIP1.  
Short Beep

## LED – Good Read

The LED indicator can be programmed **On** or **Off** in response to a good read. *Default = On.*



BEPLED1.  
\* LED - Good Read On



BEPLED0.  
LED - Good Read Off

## Number of Beeps – Good Read

The number of beeps of a good read can be programmed from 1 - 9. The same number of beeps will be applied to the beeper and LED in response to a good read. For example, if you program this option to have five beeps, there will be five beeps and five LED flashes in response to a good read. The beeps and LED flashes are in sync with one another. To change the number of beeps, scan the barcode below and then scan a digit (1-9) barcode from the [Programming Chart](#), beginning on page 289, then **Save**. *Default = 1.*



BEPRPT.  
Number of Good Read Beeps/LED Flashes

## Number of Beeps – Error

The number of beeps and LED flashes emitted by the scanner for a bad read or error can be programmed from 1 - 9. For example, if you program this option to have five error beeps, there will be five error beeps and five LED flashes in response

to an error. To change the number of error beeps, scan the barcode below and then scan a digit (1-9) barcode from the [Programming Chart](#), beginning on page 289, then **Save**. *Default = 1.*



BEPERR.

Number of Error Beeps/LED Flashes

## Good Read Delay

This sets the minimum amount of time before the scanner can read another barcode. *Default = 0 ms (No Delay).*



DLYGRD0.

\* No Delay



DLYGRD500.

Short Delay (500 ms)



DLYGRD1000.

Medium Delay (1,000 ms)



DLYGRD1500.

Long Delay (1,500 ms)

## User-Specified Good Read Delay

If you want to set your own length for the good read delay, scan the barcode below, then set the delay (from 0 - 30,000 milliseconds) by scanning digits from the [Programming Chart](#), beginning on page 289, then **Save**.



DLYGRD.

User-Specified Good Read Delay

# Trigger Modes

## Manual Trigger

When in manual trigger mode, the scanner scans until a barcode is read, or until the trigger is released. Two modes are available, **Normal** and **Enhanced**. Normal mode offers good scan speed and the longest working ranges (depth of field). Enhanced mode will give you the highest possible scan speed but slightly less range than Normal mode. Enhanced mode is best used when you require a very fast scan speed and don't require a long working range. *Default = Manual Trigger-Normal.*



PAPHHF.

\* Manual Trigger - Normal



PAPHHS.

Manual Trigger -  
Enhanced

## Trigger Toggle

Trigger Toggle mode lets you quickly hit the trigger two or three times to put the scanner into either imaging mode or centering mode, then toggle back to scanning. So, like a double-click with a mouse, you can control what the next scanner's action will be. For example, you could double-press the trigger to go into imaging mode, then the next trigger press takes the image. The scanner then reverts to scanning mode. Use the following codes to configure what action you would like the scanner to take when in Trigger Toggle mode.



TRGTGM0.

\*Trigger Toggle Off



TRGTGM1.

Trigger Toggle - Image Capture



TRGTGM3.

Trigger Toggle - Centering

## Trigger Number

This sets the number of trigger presses required to activate the Trigger Toggle Mode. *Default is 3.*



TRGTPC2.

2 Quick Triggers



TRGTPC3.

\*3 Quick Triggers



TRGTPC4.

4 Quick Triggers

## Trigger Timing

This sets the timing of the trigger presses in order to qualify as a trigger toggle, rather than a regular trigger press. After scanning the **Trigger Timing** barcode, set the time-out duration (from 50-2,000 milliseconds) by scanning digits from the [Programming Chart](#), beginning on page 289, then **Save**. *Default = 400ms.*



TRGTTI.

Trigger Timing

## Trigger Toggle Timeout

This sets the length of time the scanner stays in trigger toggle mode before reverting to scan mode. After scanning the **Trigger Toggle Timeout** barcode, set the time-out duration (from 0 to 65 seconds) by scanning digits from the [Programming Chart](#), beginning on page 289, then **Save**. *Default = 5 seconds.*

**Note:** *If this is set to 0, you must repeat the toggle sequence to return to the default scanning mode. For example, if 2 quick trigger presses puts the scanner into centering mode and the Trigger Timing is 0, you would have to do 2 quick presses again to go back to the default scanning mode.*



TRGTGT.

Trigger Toggle Timeout

## Serial Trigger

You can activate the scanner either by pressing the trigger, or using a serial trigger command (see [Trigger Commands](#) on page 228). You must be in a serial interface mode in order to use serial triggering. Refer to [RS232 Serial Port](#) (page 14) or [USB Serial](#) (page 16) for further information. When in serial mode, the scanner scans until a barcode has been read or until the deactivate command is sent. The scanner can also be set to turn itself off after a specified time has elapsed (see [Read Time-Out](#), which follows).

### Read Time-Out

Use this selection to set a time-out (in milliseconds) of the scanner's trigger when using serial commands to trigger the scanner. Once the scanner has timed out, you can activate the scanner either by pressing the trigger or using a serial trigger command. After scanning the **Read Time-Out** barcode, set the time-out duration (from 0-300,000 milliseconds) by scanning digits from the [Programming Chart](#), beginning on page 289, then **Save**. *Default = 30,000 ms.*



## Trigger Mode 11

Trigger Mode 11 provides an option for improved barcode targeting control. When activated, this enables the user to squeeze the trigger to activate only the aimer for precise targeting, then release the trigger to scan the selected barcode. Combined with [Single Code Centering](#), this can improve performance for scanning specific barcodes in regions with many barcodes present, or for precisely selecting and scanning barcodes at a distance.

Aimer will be pre-lit when trigger is pressed and scanning occurs when trigger is released until a good scan or normal scan timeout. *TRGMODO is the Default.*



# Presentation Mode

Presentation Mode uses ambient light and scanner illumination to detect barcodes. When in Presentation Mode, the LEDs remain dim until a barcode is presented to the scanner, then the aimer turns on and the LEDs turn up to read the code. If the light level in the room is not high enough, Presentation Mode may not work properly

**Note:** *Cordless Granit XP scanners can only be used in presentation mode powered by the battery; this mode cannot be used while docked.*

Scan the following barcode to program your scanner for Presentation Mode.

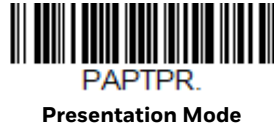

# Triggered Presentation Mode

This mode uses light to detect the presence of an object. *Default = Ambient and Scanner Light.*



# Presentation LED Behavior after Decode

When a scanner is in presentation mode, the LED aimer dims 30 seconds after a barcode is decoded. If you wish to dim the LED aimer immediately after a barcode is decoded, scan the **LEDs Off** barcode, below. *Default = LEDs On.*



# Presentation Centering

Use Presentation Centering to narrow the scanner's field of view when it is in the stand to make sure the scanner reads only those barcodes intended by the user. For instance, if multiple codes are placed closely together, Presentation Centering will insure that only the desired codes are read.

**Note:** To adjust centering when the scanner is hand-held, see [Laser Aimer - Scan Duration](#) (page 4-97).

If a barcode is not touched by a predefined window, it will not be decoded or output by the scanner. If Presentation Centering is turned on by scanning **Presentation Centering On**, the scanner only reads codes that pass through the centering window you specify using the **Top of Presentation Centering Window**, **Bottom of Presentation Centering Window**, **Left**, and **Right of Presentation Centering Window** barcodes.

In the example below, the white box is the centering window. The centering window has been set to 20% left, 30% right, 8% top, and 25% bottom. Since Barcode 1 passes through the centering window, it will be read. Barcode 2 does not pass through the centering window, so it will not be read.

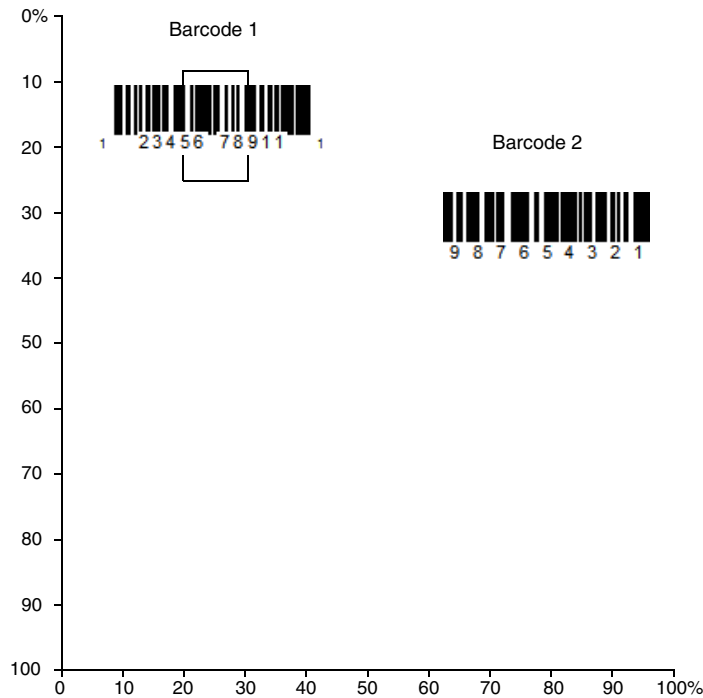

**Note:** A barcode needs only to be touched by the centering window in order to be read. It does not need to pass completely through the centering window.

Scan **Presentation Centering On**, then scan one of the following barcodes to change the top, bottom, left, or right of the centering window. Then scan the percent you want to shift the centering window from the [Programming Chart](#), beginning on page 289, then **Save**. *Default Presentation Centering = 40% for Top and Left, 60% for Bottom and Right.*



PDCWIN1.

**Presentation Centering On**



PDCWIN0.

**\* Presentation Centering Off**



PDCTOP.

**Top of Presentation  
Centering Window**



PDCBOT.

**Bottom of Presentation  
Centering Window**



PDCLFT.

**Left of  
Presentation Centering  
Window**



PDCRGT.

**Right of Presentation  
Centering Window**

For more information, see [Single Code Centering](#) on page 98.

## Near-Far Camera Modes (XR Models only)

The *Granit XP XR* scanner provides extended depth-of-field on many codes through the use of two cameras. Typically, they operate automatically switching between near and far channels as needed, however, the user can choose from the following options.



## Near Camera Only



SDRSEL0.

**Near Camera Only**

## Far Camera Only



SDRSEL1.

**Far Camera Only**

## Automatic Switching Between Near and Far Camera Channels (with steady illumination)



SDRSEL2.

**Automatic Switching \*Default**

## Alternate Switching Between Near and Far Camera Channels (with extra far field illumination)



SDRSEL3.

**Alternate Switching \*Default**

# Poor Quality Codes

## Poor Quality 1D Codes

This setting improves the scanner's ability to read damaged or badly printed linear barcodes. When **Poor Quality 1D Reading On** is scanned, poor quality linear barcode reading is improved, but the scanner's snappiness is decreased, making it less aggressive when reading good quality barcodes. This setting does not affect 2D barcode reading. *Default = Poor Quality 1D Reading Off.*



**Poor Quality 1D Reading On**



**\* Poor Quality 1D Reading Off**

## Poor Quality PDF Codes

This setting improves the scanner's ability to read damaged or badly printed PDF codes by combining information from multiple images. It is useful when a complete barcode cannot be seen in one image. This setting does not affect 1D barcode reading. *Default = Poor Quality PDF Reading On.*



**\*Poor Quality PDF Reading On**



**Poor Quality PDF Reading Off**

## Low Resolution PDF Codes

This setting improves the scanner's ability to read low resolution PDF codes. When **Low Resolution PDF Codes On** is scanned, poor quality PDF code reading is improved, but the scanner's snappiness is decreased, making it less aggressive when reading good quality barcodes. This setting does not affect 1D barcode reading. *Default = Low Resolution PDF Codes Off.*



**Low Resolution PDF Codes On**



PDFDM10.

\* Low Resolution PDF Codes  
Off

## CodeGate™

When CodeGate is **On**, the trigger is used to allow decoded data to be transmitted to the host system. The scanner remains on, scanning and decoding barcodes, but the barcode data is not transmitted until the trigger is pressed. When CodeGate is **Off**, barcode data is transmitted when it is decoded. *Default = CodeGate Off.*



AOSCGD0.

\* CodeGate Off



AOSCGD1.

CodeGate On

## Streaming Presentation™ Mode

When in Streaming Presentation mode, the scanner's aimer goes out after a short time, but the scan illumination remains on all the time to continuously search for barcodes. Two modes are available, **Normal** and **Enhanced**. Normal mode offers good scan speed and the longest working ranges (depth of field). Enhanced mode will give you the highest possible scan speed but slightly less range than Normal mode. Enhanced mode is best used when you require a very fast scan speed and don't require a long working range.



PAPSPN.

Streaming Presentation  
Mode - Normal



PAPSPE.

Streaming Presentation  
Mode - Enhanced

When using (page 4-100), a lower priority symbol must be centered on the aiming pattern to be read in Streaming Presentation Mode.

**Note:** *Cordless Granit XP scanners can only be used in presentation mode powered by the battery; this mode cannot be used while docked.*

# Hands Free Time-Out

The Scan Stand and Presentation Modes are referred to as “hands free” modes. If the scanner’s trigger is pulled when using a hands free mode, the scanner changes to manual trigger mode. You can set the time the scanner should remain in manual trigger mode by setting the Hands Free Time-Out. Once the time-out value is reached, (if there have been no further trigger pulls) the scanner reverts to the original hands free mode.

Scan the **Hands Free Time-Out** barcode, then scan the time-out duration (from 0-300,000 milliseconds) from the [Programming Chart](#), beginning on page 289, then **Save**. *Default = 5,000 ms.*



# Reread Delay

This sets the time period before the scanner can read the *same* barcode a second time. Setting a reread delay protects against accidental rereads of the same barcode. Longer delays are effective in minimizing accidental rereads. Use shorter delays in applications where repetitive barcode scanning is required. Reread Delay only works when in a [Presentation Mode](#) (see page 86). *Default = Medium.*



## User-Specified Reread Delay

If you want to set your own length for the reread delay, scan the barcode below, then set the delay (from 0-30,000 milliseconds) by scanning digits from the [Programming Chart](#), beginning on page 289, then **Save**.



## 2D Reread Delay

Sometimes 2D barcodes can take longer to read than other barcodes. If you wish to set a separate Reread Delay for 2D barcodes, scan one of the programming codes that follows. **2D Reread Delay Off** indicates that the time set for [Reread Delay](#) is used for both 1D and 2D barcodes. *Default = 2D Reread Delay Off.*



## Character Activation

You may use a character sent from the host to trigger the scanner to begin scanning. When the activation character is received, the scanner continues scanning until either the [Character Activation Timeout](#) (page 4-95) is reached, the deactivation character is received (see [Deactivation Character](#) on page 95), or a barcode is

transmitted. Scan the **On** barcode to use character activation, then use [Activation Character](#) (page 94) to select the character you will send from the host to start scanning. *Default = Off.*



## Activation Character

This sets the character used to trigger scanning when using Character Activation Mode. On the [ASCII Conversion Chart \(Code Page 1252\)](#), page 280, find the hex value that represents the character you want to use to trigger scanning. Scan the following barcode, then use the [Programming Chart](#) to read the alphanumeric combination that represents that ASCII character. Scan **Save** to finish. *Default = 12 [DC2].*



## End Character Activation After Good Read

After a barcode is successfully detected and read from the scanner, the illumination can be programmed either to remain on and scanning, or to turn off. When **End Character Activation After Good Read** is enabled, the illumination turns off and stops scanning after a good read. If you scan **Do Not End Character Activation After Good Read**, the illumination remains on after a good read.



## Character Activation Timeout

You can set a timeout for the length of time the illumination remains on and attempting to decode barcodes when using Character Activation Mode. Set the length (in milliseconds) for a timeout by scanning the following barcode, then setting the timeout (from 1-300,000 milliseconds) by scanning digits from the [Programming Chart](#), beginning on page 289, then **Save**. *Default = 30,000 ms.*



HSTCDT.

Character Activation Timeout

## Character Deactivation

If you have sent a character from the host to trigger the scanner to begin scanning, you can also send a deactivation character to stop scanning. Scan the following **On** barcode to use character deactivation, then use **Deactivation Character** (following) to select the character you will send from the host to terminate scanning. *Default = Off.*



HSTDEN0.

\* Off



HSTDEN1.

On

## Deactivation Character

This sets the character used to terminate scanning when using Character Deactivation Mode. On the [ASCII Conversion Chart \(Code Page 1252\)](#), page 280, find the hex value that represents the character you want to use to terminate scanning. Scan the following barcode, then use the [Programming Chart](#), beginning on page 289 to read the alphanumeric combination that represents that ASCII character. Scan **Save** to finish. *Default = 14 [DC4].*



HSTDCH.

Deactivation Character

# Illumination Lights

If you want the illumination lights on while reading a barcode, scan the **Lights On** barcode, below. However, if you want to turn just the lights off, scan the **Lights Off** barcode. *Default = Lights On.*

**Note:** *This setting does not affect the aimer light. The aiming light can be set using [Aimer Mode](#) (page 97).*



SCNLED1.  
\* Lights On



SCNLED0.  
Lights Off

# Aimer Delay

The aimer delay allows a delay time for the operator to aim the scanner before the picture is taken. Use these codes to set the time between when the trigger is pulled and when the picture is taken. During the delay time, the aiming light will appear, but the LEDs won't turn on until the delay time is over. *Default = Off.*



SCNDLY1.  
1 millisecond



SCNDLY250.  
250 milliseconds



SCNDLY500.  
500 milliseconds



SCNDLY0.  
\* Off (no delay)



## User-Specified Aimer Delay

If you want to set your own length for the duration of the delay, scan the barcode below, then set the time-out by scanning digits (0 - 4,000 ms) from the [Programming Chart](#), beginning on page 289, then **Save**.



## Aimer Mode

This feature allows you to turn the aimer on and off. When the **Interlaced** barcode is scanned, the aimer is interlaced with the illumination LEDs. *Default = Interlaced*



## Laser Aimer - Scan Duration

Use the following bar codes to specify how long you want the laser aimer to remain on after the trigger is released. Scan the 10 Second Scan Duration bar code to set the duration to 10 seconds (default) . Scan the Laser Aimer - Scan Duration bar code to set a different duration, then set the duration by scanning digits (0 - 65,535 ms) from the Programming Chart, beginning on page 353. Scan Save to finish.



# Centering

Use Centering to narrow the scanner's field of view to make sure that when the scanner is hand-held, it reads only those barcodes intended by the user. For instance, if multiple codes are placed closely together, centering will insure that only the desired codes are read. (Centering can be used in conjunction with [Aimer Delay](#), page 96, for the most error-free operation in applications where multiple codes are spaced closely together. Using the Aimer Delay and Centering features, the scanner can emulate the operation of older systems, such as linear laser barcode scanners.)

**Note:** To adjust centering when the scanner is in a stand, see [Presentation Centering](#) (page 4-87).

## Single Code Centering

Scan **Single Code Centering** to target the barcode closest to the center of the image. Singling out a barcode in this manner increases scanning accuracy when there are multiple barcodes close together.



Single Code Centering

## Custom Centering

Use the following settings to customize your centering window. If a barcode is not touched by a predefined window, it will not be decoded or output by the scanner. If centering is turned on by scanning **Centering On**, the scanner only reads codes that pass through the centering window you specify using the **Top of Centering Window**, **Bottom of Centering Window**, **Left**, and **Right of Centering Window** barcodes.

**Example:** In the example below, the white box is the centering window. The centering window has been set to 20% left, 30% right, 8% top, and 25% bottom. Since Barcode 1 passes through the centering window, it will be read. Barcode 2 does not pass through the centering window, so it will not be read.

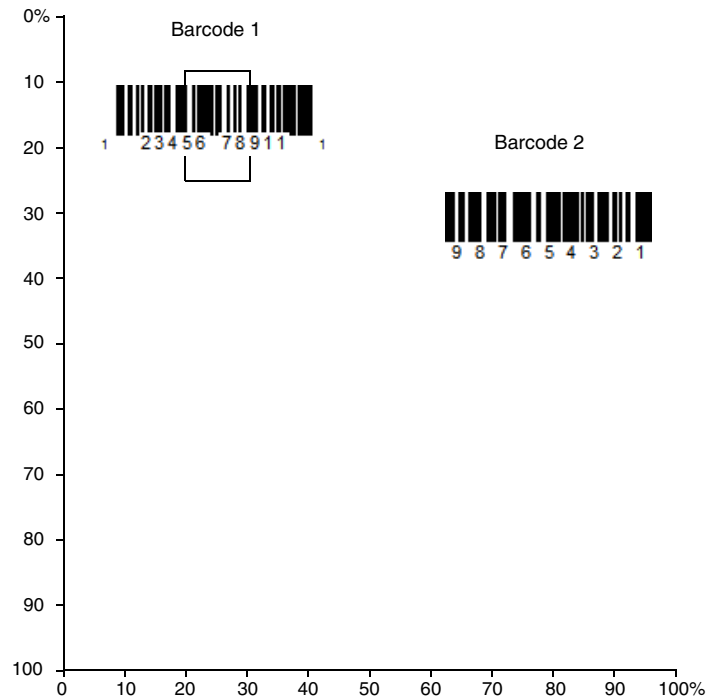

**Note:** A barcode needs only to be touched by the centering window in order to be read. It does not need to pass completely through the centering window.

Scan **Centering On**, then scan one of the following barcodes to change the top, bottom, left, or right of the centering window. Then scan the percent you want to shift the centering window using digits from the [Programming Chart](#), beginning on page 289, then **Save**. Default Centering = 40% for Top and Left, 60% for Bottom and Right.





## Preferred Symbology

The scanner can be programmed to specify one symbology as a higher priority over other symbologies in situations where both barcode symbologies appear on the same label, but the lower priority symbology cannot be disabled.

For example, you may be using the scanner in a retail setting to read U.P.C. symbols, but have occasional need to read a code on a drivers license. Since some licenses have a Code 39 symbol as well as the PDF417 symbol, you can use Preferred Symbology to specify that the PDF417 symbol be read instead of the Code 39.

Preferred Symbology classifies each symbology as high priority, low priority, or as an unspecified type. When a low priority symbology is presented, the scanner ignores it for a set period of time (see [Preferred Symbology Time-out](#) on page 101) while it searches for the high priority symbology. If a high priority symbology is located during this period, then that data is read immediately.

If the time-out period expires before a high priority symbology is read, the scanner will read any barcode in its view (low priority or unspecified). If there is no barcode in the scanner's view after the time-out period expires, then no data is reported.

**Note:** A low priority symbol must be centered on the aiming pattern to be read.

Scan a barcode below to enable or disable Preferred Symbology. *Default = Preferred Symbology Off.*



## High Priority Symbology

To specify the high priority symbology, scan the **High Priority Symbology** barcode below. On the [Symbology Charts](#) on page 277, find the symbology you want to set as high priority. Locate the Hex value for that symbology and scan the 2 digit hex value from the [Programming Chart](#), beginning on page 289, then **Save**. *Default = None.*



## Low Priority Symbology

To specify the low priority symbology, scan the **Low Priority Symbology** barcode below. On the [Symbology Charts](#) on page 277, find the symbology you want to set as low priority. Locate the Hex value for that symbology and scan the 2 digit hex value from the [Programming Chart](#), beginning on page 289.

If you want to set additional low priority symbologies, scan **FF**, then scan the 2 digit hex value from the [Programming Chart](#), beginning on page 289, for the next symbology. You can program up to 5 low priority symbologies. Scan **Save** to save your selection. *Default = None.*



## Preferred Symbology Time-out

Once you have enabled Preferred Symbology and entered the high and low priority symbologies, you must set the time-out period. This is the period of time the scanner will search for a high priority barcode after a low priority barcode has been encountered. Scan the barcode below, then set the delay (from 1–3,000 milliseconds) by scanning digits from the [Programming Chart](#), beginning on page 289, then **Save**. *Default = 500 ms.*



## Preferred Symbology Default

Scan the barcode below to set all Preferred Symbology entries to their default values.



# Output Sequence Overview

## Output Sequence Editor

This programming selection allows you to program the scanner to output data (when scanning more than one symbol) in whatever order your application requires, regardless of the order in which the barcodes are scanned. You can define up to 15 barcodes in an output sequence.

**Note:** To make Output Sequence Editor selections, you'll need to know the code I.D., code length, and character match(es) your application requires. Use the alphanumeric symbols from the [Programming Chart](#), beginning on page 289. You must hold the trigger while reading each barcode in the sequence.

## To Add an Output Sequence

An output sequence is created using a string of serial commands that is sent to the scanner. This string is most easily sent to the scanner using the EZConfig software tool (see [EZConfig for Scanning Introduction](#) on page 223). You can also accomplish this by scanning alphanumeric barcodes (see the [Programming Chart](#), beginning on page 289).

1. If you are using barcodes to create your output sequence, scan [Enter Output Sequence](#) on page 105.
2. **Code I.D.**  
On the [Symbology Charts](#) on page 277, find the symbology to which you want to apply the output sequence format. Make a note of the hex value for that symbology. If you are using barcodes to create your output sequence, scan the 2 digit hex value from the [Programming Chart](#), beginning on page 289.
3. **Length**  
Specify what length (up to 9999 characters) of data output will be acceptable for this symbology. Make a note of the length. If you are using barcodes to create your output sequence, scan the 4 digit data length [Programming Chart](#), beginning on page 289. (Note: 50 characters is entered as **0050**. 9999 is a universal number, indicating all lengths.) When calculating the length, you must count any programmed prefixes, suffixes, or formatted characters as part of the length (unless using 9999).
4. **Character Match Sequences**  
On the [ASCII Conversion Chart \(Code Page 1252\)](#), page 280, find the hex value that represents the character(s) you want to match. Make a note of the hex value for the character(s). If you are using barcodes to create your output sequence, use the [Programming Chart](#), beginning on page 289 to read the alphanumeric combination that represents the ASCII characters. (99 is the universal number, indicating all characters.)
5. **End Output Sequence Editor**  
Use **FF** to terminate this string or to begin another output sequence. If you are using barcodes, scan **F F**. Scan **Save** to save your entries.

## Other Programming Selections

If you are creating an output sequence using barcodes, scan **Discard** (page 290) to exit without saving any output sequence changes.

## Output Sequence Editor Commands

<b>SEQBLK</b>	Sequence editor start command.
<b>SEQPRE</b>	Add prefix to complete output sequences.
<b>SEQSUF</b>	Add suffix to complete output sequences.
<b>SEQSEP</b>	Add separators to complete output sequences.
<b>SEQTTS1</b>	Transmit partial sequence.
<b>SEQSAT</b>	Define satisfactory subsets of full output sequence.
<b>SEQTIM</b>	Timeout for sequence members when using SEQSAT.
<b>SEQIPR</b>	Add prefix to partial output sequences.
<b>SEQISU</b>	Add suffix to partial output sequences.
<b>SEQISE</b>	Add separators to partial output sequences.
<b>TRGSTO</b>	Timeout for partial output sequences.
<b>FF</b>	Termination string.

Examples outlining how to use these commands are shown below.

### Output Sequence Example 1 - Three Symbologies



In this example, you are scanning PDF417, Code 128, and Code 39 barcodes, but you want the scanner to output Code 39 first, Code 128 second, and PDF417 third.

Set up the sequence editor with the following command line:

<b>SEQBLK</b>	sequence editor start command
<b>62</b>	code identifier for Code 39
<b>9999</b>	code length that must match for Code 39, 9999 = all lengths

<b>43</b>	start character match for Code 39, 43h = "C"
<b>FF</b>	termination string for first code
<b>6A</b>	code identifier for Code 128
<b>9999</b>	code length that must match for Code 128, 9999 = all lengths
<b>54</b>	start character match for Code 128, 54h = "T"
<b>FF</b>	termination string for first code
<b>72</b>	code identifier for PDF417
<b>9999</b>	code length that must match for PDF417, 9999 = all lengths
<b>4D</b>	start character match for PDF417, 4Dh = "M"
<b>FF</b>	termination string for third code

The whole command line would look like this:

**SEQBLK62999943FF6A999954FF7299994DFF**

The data is output as:

**CODE39SMPLTSTMSGCODE128MSGPDF417**

See the next example to further refine this output.

## Output Sequence Example 2 - Three Symbologies with <> Separators

In this example, you are scanning the same three barcodes, but you want <> brackets and a carriage return and line feed to separate your output.



The sequence editor would use the same command line as shown in [Output Sequence Example 1 - Three Symbologies](#) (page 103):

<b>SEQBLK</b>	sequence editor start command
<b>62</b>	code identifier for Code 39
<b>9999</b>	code length that must match for Code 39, 9999 = all lengths
<b>43</b>	start character match for Code 39, 43h = "C"
<b>FF</b>	termination string for first code
<b>6A</b>	code identifier for Code 128



<b>9999</b>	code length that must match for Code 128, 9999 = all lengths
<b>54</b>	start character match for Code 128, 54h = "T"
<b>FF</b>	termination string for first code
<b>72</b>	code identifier for PDF417
<b>9999</b>	code length that must match for PDF417, 9999 = all lengths
<b>4D</b>	start character match for PDF417, 4Dh = "M"
<b>FF</b>	termination string for third code

But you would add your <> separators for each sequence:

<b>SEQSEP99</b>	separator for each sequence, 99 = all symbologies
<b>3C</b>	left bracket (<)
<b>3E</b>	right bracket (>)

And add the carriage return and line feed as a suffix:

<b>SEQSUF99</b>	separator for suffixes, 99 = all symbologies
<b>0D</b>	carriage return
<b>0A</b>	line feed

The whole command line would look like this:

**SEQBLK62999943FF6A999954FF7299994DFFSEQSEP993C3ESEQSUF990D0A**

The data is output as:

**<CODE39SMPL>**  
**<TSTMSGCODE128>**  
**<MSGPDF417>**

## Enter Output Sequence

If you are using barcodes to create your output sequence, scan **Enter Output Sequence** to begin scanning your string.



**Enter Output Sequence**

## Partial Sequence

If an output sequence operation is terminated before all your output sequence criteria are met, the barcode data acquired to that point is a “partial sequence.” You can define how partial sequences are output using the same types of command strings you used to create output sequences.

### Partial Sequence Example - Three Symbologies with <> Separators, but with a Damaged Code

In this example, you are scanning PDF417, Code 128, and Code 39 barcodes, and you want the scanner to output Code 39 first, Code 128 second, and PDF417 third, in brackets, as shown below, but the Code 39 barcode has been damaged and cannot be output.



You would use the same command line as shown in [Output Sequence Example 2 - Three Symbologies with <> Separators](#) (page 104):

<b>SEQBLK</b>	sequence editor start command
<b>62</b>	code identifier for Code 39
<b>9999</b>	code length that must match for Code 39, 9999 = all lengths
<b>43</b>	start character match for Code 39, 43h = "C"
<b>FF</b>	termination string for first code
<b>6A</b>	code identifier for Code 128
<b>9999</b>	code length that must match for Code 128, 9999 = all lengths
<b>54</b>	start character match for Code 128, 54h = "T"
<b>FF</b>	termination string for first code
<b>72</b>	code identifier for PDF417
<b>9999</b>	code length that must match for PDF417, 9999 = all lengths
<b>4D</b>	start character match for PDF417, 4Dh = "M"
<b>FF</b>	termination string for third code

<b>SEQSEP99</b>	separator for each sequence, 99 = all symbologies
<b>3C</b>	left bracket (<)
<b>3E</b>	right bracket (>)
<b>SEQSUF99</b>	separator for suffixes, 99 = all symbologies
<b>0D</b>	carriage return
<b>0A</b>	line feed

And you would add **>PARTIAL<** as the prefix to note the partial sequence:

<b>SEQTTS1</b>	transmit partial sequence
<b>SEQISU99</b>	add partial sequence prefix, 99 = all symbologies
<b>3E</b>	right bracket (>)
<b>50</b>	P
<b>41</b>	A
<b>52</b>	R
<b>54</b>	T
<b>49</b>	I
<b>41</b>	A
<b>4C</b>	L
<b>3C</b>	left bracket (<)

The whole command line would look like this:

**SEQBLK62999943FF6A999954FF7299994DFFSEQSEP993C3ESEQSUF990D0  
ASEQTTS1SEQISU993E5041525449414C3C**

The data is output as:

**>PARTIAL<**  
**<TSTMSGCODE128>**  
**<MSGPDF417>**

## Discard Partial Output Sequence

If you want to discard partial sequences when the output sequence operation is terminated before completion, scan **Discard Partial Sequence**.



SEQTTS0.

\* Discard Partial Sequence

## Output Sequence Timeouts

You can set a timeout for every code in the output sequence defined by the SEQBLK command. The scanner applies the shortest timeout corresponding to any of the codes that have been read during the current trigger session. When the timeout expires, the scanner sends all codes that it has been read in the order they appear in the sequence defined by SEQBLK.

To specify the timeout, use the SEQTIM command followed by a list of timeouts in milliseconds. Each timeout is specified as a 4-decimal digit terminated by FF. The timeout value 9999 is special and indicates that the timeout for that code is “infinite”.

The number of timeouts specified should correspond to the number of codes in the sequence defined by SEQBLK. You can specify one additional timeout, which will apply to codes not matching any member of the sequence. This can be useful if Require Output Sequence is **On/Not Required**. If you do not specify an additional timeout for codes not in the defined sequence, the last timeout specified by SEQTIM will apply.

### Output Sequence Timeout Example

For example, if SEQBLK defines a 4-code sequence, you can specify timeouts of 5, 6, 7, and 8 seconds for codes 1-4 respectively using the command **SEQTIM5000FF6000FF7000FF8000FF**. Codes that are not part of the defined sequence would have an implied timeout of 8 seconds in this case (the final timeout in the list). To explicitly specify a timeout for such codes, you can include one more timeout at the end of the list. For example, to include a timeout of 1 second for non-sequence codes, use the command **SEQTIM5000FF6000FF7000FF8000FF1000FF**.

### Satisfactory Subset of Full Sequence

You can define one or more subsets of barcodes from the complete sequence specified by SEQBLK. When you scan all the codes from one of these subsets, the scanner will transmit all the codes it has read in the sequence. The scanner sends the codes in the order defined by SEQBLK.

**Note:** *To use the satisfactory subset feature, you must supply a timeout for each code in the sequence using SEQTIM.*

### Satisfactory Subset of Full Sequence Timeout Example

To specify a subset, list its members using the SEQSAT command and terminate each subset with FF. The members of each subset are specified as single hex digits corresponding to their index within the full sequence, 1 being the first. For example, to specify two subsets, the first consisting of the first and second code in the sequence and the second subset consisting of the second and third code, use the command **SEQSAT12FF23FF**.

To define a subset with an odd number of codes, insert a 0 before the final code index. For example, to define a 3-code subset consisting of the first, second, and third codes, use the command **SEQSAT1203FF**.

## Default Output Sequence

**Default Sequence** programs the scanner to all universal values. Be certain you want to delete or clear all formats before you read the **Default Sequence** symbol.



## Require Output Sequence

When an output sequence is **Required**, all output data must conform to an edited sequence or the scanner will not transmit the output data to the host device. When it's **On/Not Required**, the scanner will attempt to get the output data to conform to an edited sequence but, if it cannot, the scanner transmits all output data to the host device as is, or formatted according to the partial sequence output format (see [Partial Sequence](#) on page 106).

When the output sequence is **Off**, the barcode data is output to the host as the scanner decodes it. *Default = Off.*

**Note:** *This selection is unavailable when the Multiple Symbols Selection is turned on.*



## Good Read Tone - Output Sequences

The scanner may be programmed to either beep or click in response to a good read of each barcode in an output sequence, or to emit a beep or error tone for a partial sequence. *Default = Good Read Click - Each Code in Sequence and Error Tone - Partial Sequence Output.*



BEPSIN0.

Good Read Beep - Each  
Code in Sequence



BEPSIN1.

\* Good Read Click - Each  
Code in Sequence



BEPISE0.

Good Read Beep - Partial  
Sequence Output



BEPISE1.

\* Error Tone - Partial  
Sequence Output

## Multiple Symbols

When this programming selection is turned **On**, it allows you to read multiple symbols with a single pull of the scanner's trigger. If you press and hold the trigger, aiming the scanner at a series of symbols, it reads unique symbols once, beeping and or vibrating (if turned on) for each read. The scanner attempts to find and decode new symbols as long as the trigger is pulled. The maximum number of barcodes read is 21. When this programming selection is turned **Off**, the scanner will only read the symbol closest to the aiming beam. *Default = Off.*



SHOTGN1.

On



SHOTGN0.

\* Off

# No Read

With No Read turned **On**, the scanner notifies you if a code cannot be read. If using an EZConfig-Scanning Tool Scan Data Window (see page 223), an “NR” appears when a code cannot be read. If No Read is turned **Off**, the “NR” will not appear.  
*Default = Off.*



If you want a different notation than “NR,” for example, “Error,” or “Bad Code,” you can edit the output message (see [Data Format](#) beginning on page 119). The hex code for the No Read symbol is **9C**.

# Video Reverse

Video Reverse is used to allow the scanner to read barcodes that are inverted. The **Video Reverse Off** barcode below is an example of this type of barcode. Scan **Video Reverse Only** to read *only* inverted barcodes. Scan **Video Reverse and Standard Barcodes** to read both types of codes.

**Note:** After scanning **Video Reverse Only**, menu barcodes cannot be read. You must scan **Video Reverse Off** or **Video Reverse and Standard Barcodes** in order to read menu barcodes.

**Note:** Images downloaded from the unit are not reversed. This is a setting for decoding only.





\* Video Reverse Off

## Working Orientation

Some barcodes are direction-sensitive. For example, KIX codes and OCR can mis-read when scanned sideways or upside down. Use the working orientation settings if your direction-sensitive codes will not usually be presented upright to the scanner. *Default = Upright.*

Upright:



Upside Down:



Vertical, Top to Bottom:  
(Rotate CW 90°)



Vertical, Bottom to Top:  
(Rotate CCW 90°)



ROTATN0.

\* Upright



ROTATN2.

Upside Down



ROTATN1.

Vertical, Bottom to Top



ROTATN3.

Vertical, Top to Bottom



## Prefix/Suffix Overview

When a barcode is scanned, additional information is sent to the host computer along with the barcode data. This group of barcode data and additional, user-defined data is called a “message string.” The selections in this section are used to build the user-defined data into the message string.

Prefix and Suffix characters are data characters that can be sent before and after scanned data. You can specify if they should be sent with all symbologies, or only with specific symbologies. The following illustration shows the breakdown of a message string:

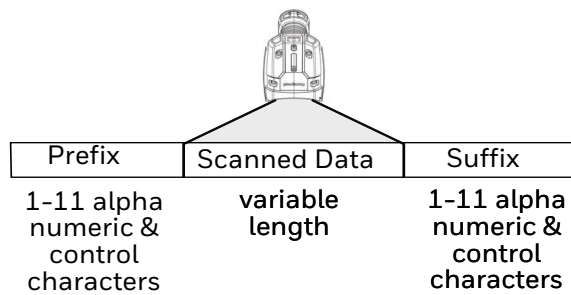

## Points to Keep In Mind

- It is not necessary to build a message string. The selections in this chapter are only used if you wish to alter the default settings. *Default prefix = None. Default suffix = None.*
- A prefix or suffix may be added or cleared from one symbology or all symbologies.
- You can add any prefix or suffix from the [ASCII Conversion Chart \(Code Page 1252\)](#), beginning on page 280, plus Code I.D. and AIM I.D.
- You can string together several entries for several symbologies at one time.
- Enter prefixes and suffixes in the order in which you want them to appear on the output.

- When setting up for specific symbologies (as opposed to all symbologies), the specific symbology ID value counts as an added prefix or suffix character.
- The maximum size of a prefix or suffix configuration is 200 characters, which includes header information.

## Add a Prefix or Suffix:

- Step 1. Scan the **Add Prefix** or **Add Suffix** symbol ([page 115](#)).
- Step 2. Determine the 2 digit hex value from the [Symbology Charts](#) (beginning on page 277) for the symbology to which you want to apply the prefix or suffix. For example, for Code 128, Code ID is “j” and Hex ID is “6A”.
- Step 3. Scan the 2 hex digits from the [Programming Chart](#), beginning on page 289, or scan **9, 9** for all symbologies.

To add the Code I.D., scan **5, C, 8, 0**.

To add the AIM I.D., scan **5, C, 8, 1**.

To add the serial number, scan **5, C, 8, 8**.

To add a backslash (\), scan **5, C, 5, C**.

**Note:** When adding a backslash (\), you must scan 5C twice – once to create the leading backslash and then to create the backslash itself.

- Step 4. Repeat Steps 2 and 3 for every prefix or suffix character.
  - Step 5. Scan **Save** to exit and save, or scan **Discard** to exit without saving.
- Repeat the steps above to add a prefix or suffix for another symbology.

## Example: Add a Tab Suffix to All Symbologies

- Step 1. Scan **Add Suffix**.
- Step 2. Scan **9, 9** from the [Programming Chart](#), beginning on page 289 to apply this suffix to all symbologies.
- Step 3. Scan **0, 9** from the [Programming Chart](#), beginning on page 289. This corresponds with the hex value for a horizontal tab, shown in the [ASCII Conversion Chart \(Code Page 1252\)](#), beginning on page 280.
- Step 4. Scan **Save**, or scan **Discard** to exit without saving.

## Clear One or All Prefixes or Suffixes

You can clear a single prefix or suffix, or clear all prefixes/suffixes for a symbology. If you have been entering prefixes and suffixes for single symbologies, you can use **Clear One Prefix (Suffix)** to delete a specific character from a symbology. When you **Clear All Prefixes (Suffixes)**, all the prefixes or suffixes for a symbology are deleted.

- Step 1. Scan the **Clear One Prefix** or **Clear One Suffix** symbol.
- Step 2. Determine the 2 digit hex value from the Symbology Chart (included in the [Symbology Charts](#), beginning on page 277) for the symbology from which you want to clear the prefix or suffix.
- Step 3. Scan the 2 digit hex value from the [Programming Chart](#), beginning on page 289 or scan **9, 9** for all symbologies.

Your change is automatically saved.

## Add a Carriage Return Suffix to All Symbologies

Scan the following barcode if you wish to add a carriage return suffix to all symbologies at once. This action first clears all current suffixes, then programs a carriage return suffix for all symbologies.



## Prefix Selections

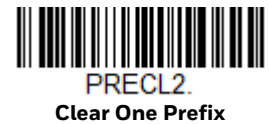

## Suffix Selections

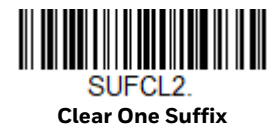

# Function Code Transmit

By default, all ASCII control characters are transmitted with barcode data. These non-printable characters are translated into predefined key strokes, or CTRL+X functions (see [ASCII Conversion Chart \(Code Page 1252\)](#), beginning on page 280). If these key strokes interfere with your host's software application, scan **Disable** to keep these ASCII control characters from being transmitted. *Default = Enable.*



**Note:** You can also use a custom data format (see [Data Format](#) beginning on page 119) to translate these characters into a more meaningful output.

## Intercharacter, Interfunction, and Intermessage Delays

Some terminals drop information (characters) if data comes through too quickly. Intercharacter, interfunction, and intermessage delays slow the transmission of data, increasing data integrity.

### Intercharacter Delay

An intercharacter delay of up to 5000 milliseconds (in 5ms increments) may be placed between the transmission of each character of scanned data. Scan the **Intercharacter Delay** barcode below, then scan the number of 5ms delays from the [Programming Chart](#), beginning on page 289, then **Save**.

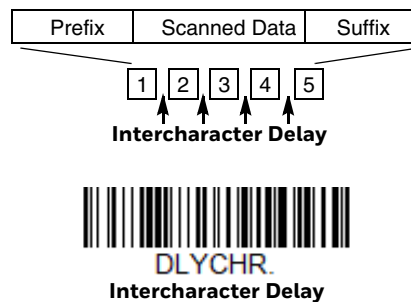

To remove this delay, scan the **Intercharacter Delay** barcode, then set the number of delays to 0. Scan the **Save** barcode from the [Programming Chart](#), beginning on page 289.

**Note:** Intercharacter delays are not supported in USB serial emulation.

# User Specified Intercharacter Delay

An intercharacter delay of up to 5000 milliseconds (in 5ms increments) may be placed after the transmission of a particular character of scanned data. Scan the **Delay Length** barcode below, then scan the number of 5ms delays from the [Programming Chart](#), beginning on page 289, then **Save**.

Next, scan the **Character to Trigger Delay** barcode, then the 2-digit hex value for a printable character to trigger the delay (see [Lower ASCII Reference Table](#), page 281.)



To remove this delay, scan the **Delay Length** barcode, and set the number of delays to **0**. Scan the **Save** barcode from the [Programming Chart](#), beginning on page 289.

# Interfunction Delay

An interfunction delay of up to 5000 milliseconds (in 5ms increments) may be placed between the transmission of each control character in the message string. Scan the **Interfunction Delay** barcode below, then scan the number of 5ms delays, and the **Save** barcode from the [Programming Chart](#), beginning on page 289.

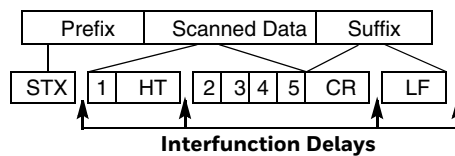

To remove this delay, scan the **Interfunction Delay** barcode, then set the number of delays to 0. Scan the **Save** barcode from the [Programming Chart](#), beginning on page 289.

# Intermessage Delay

An intermessage delay of up to 5000 milliseconds (in 5ms increments) may be placed between each scan transmission. Scan the **Intermessage Delay** barcode below, then scan the number of 5ms delays, and the **Save** barcode from the [Programming Chart](#), beginning on page 289.

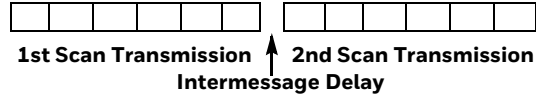

DLYMSG.  
Intermessage Delay

To remove this delay, scan the **Intermessage Delay** barcode, then set the number of delays to **0**. Scan the **Save** barcode from the [Programming Chart](#), beginning on page 289.

## Data Format Editor Introduction

You may use the Data Format Editor to change the scanner's output. For example, you can use the Data Format Editor to insert characters at certain points in barcode data as it is scanned. The selections in the following pages are used only if you wish to alter the output. *Default Data Format setting = None.*

Normally, when you scan a barcode, it is output automatically. However, when you create a format, you must use a "send" command (see [Send Commands](#) on page 122) within the format program to output data.

Multiple formats may be programmed into the scanner. They are stacked in the order in which they are entered. However, the following list presents the order in which formats are applied:

1. Specific Terminal ID, Actual Code ID, Actual Length
2. Specific Terminal ID, Actual Code ID, Universal Length
3. Specific Terminal ID, Universal Code ID, Actual Length
4. Specific Terminal ID, Universal Code ID, Universal Length
5. Universal Terminal ID, Actual Code ID, Actual Length
6. Universal Terminal ID, Actual Code ID, Universal Length
7. Universal Terminal ID, Universal Code ID, Actual Length
8. Universal Terminal ID, Universal Code ID, Universal Length

The maximum size of a data format configuration is 2000 bytes, which includes header information.

If a barcode is read that fails the first data format, the next data format, if there is one, will be used on the barcode data. If there is no other data format, the raw data is output.

If you have changed data format settings, and wish to clear all formats and return to the factory defaults, scan the **Default Data Format** code below.



## Show Data Format

Scan the barcode below to show current data format settings.



## Add a Data Format

- Step 1. Scan the **Enter Data Format** symbol ([page 121](#)).
- Step 2. **Select Primary/Alternate Format**  
Determine if this will be your primary data format, or one of 3 alternate formats. This allows you to save a total of 4 different data formats. To program your primary format, scan **0** from the [Programming Chart](#), beginning on page 289. If you are programming an alternate format, scan **1, 2, or 3**, depending on which alternate format you are programming. (See [Primary/Alternate Data Formats](#) on page 137 for further information.)
- Step 3. **Terminal Type**  
Refer to [Terminal ID Table](#) (page 122) and locate the Terminal ID number for your PC. Scan three numeric barcodes from the [Programming Chart](#), beginning on page 289, to program the scanner for your terminal ID (you must enter 3 digits). For example, scan **0 0 3** for an AT wedge.

**Note:** **099** indicates all terminal types.

- Step 4. **Code I.D.**  
In the [Symbology Charts](#), beginning on page 277, find the symbology to which you want to apply the data format. Locate the Hex value for that symbology and scan the 2 digit hex value from the [Programming Chart](#), beginning on page 289.

If you wish to create a data format for all symbologies, with the exception of some specific symbologies, refer to B8 ([page 135](#)).

If you are creating a data format for Batch Mode Quantity, use **35** for the Code I.D.

**Note:** **99** indicates all symbologies.

- Step 5. **Length**  
Specify what length (up to 9999 characters) of data will be acceptable for this symbology. Scan the four digit data length from the [Programming](#)



[Chart](#), beginning on page 289. For example, 50 characters is entered as **0050**.

**Note:** **9999** indicates all lengths.

Step 6. **Editor Commands**

Refer to [Data Format Editor Commands](#) (page 122). Scan the symbols that represent the command you want to enter.

Step 7. Scan **Save** to save your data format, or **Discard** to exit without saving your changes.



## Other Programming Selections

- **Clear One Data Format**

This deletes one data format for one symbology. If you are clearing the primary format, scan **0** from the [Programming Chart](#), beginning on page 289. If you are clearing an alternate format, scan **1**, **2**, or **3**, depending on the format you are clearing. Scan the Terminal Type and Code I.D. (see [Symbology Charts](#) on page 277), and the barcode data length for the specific data format that you want to delete. All other formats remain unaffected.

- **Clear all Data Formats**

This clears all data formats.

- **Save**

Exit and save your data format changes.

- **Discard**

Exit without saving any data format changes.





## Terminal ID Table

Terminal	Model(s)	Terminal ID
USB	PC keyboard (HID)	124
	Mac Keyboard	125
	PC Keyboard (Japanese)	134
	Serial (COM driver required)	130
	HID POS	131
	USB SurePOS Handheld	128
	USB SurePOS Tabletop	129
	Serial	RS232 TTL
RS232 True		000
RS485 (IBM-HHBCR 1+2, 46xx)		051
Keyboard	PS2 compatibles	003
	AT compatibles	002

## Data Format Editor Commands

When working with the Data Format Editor, a virtual cursor is moved along your input data string. The following commands are used to both move this cursor to different positions, and to select, replace, and insert data into the final output.

### Send Commands

#### Send all characters

- F1** Include in the output message all of the characters from the input message, starting from current cursor position, followed by an insert character. *Syntax = F1xx* where xx stands for the insert character's hex value for its ASCII code. Refer to the [ASCII Conversion Chart \(Code Page 1252\)](#), beginning on page 280 for decimal, hex and character codes.

## Send a number of characters

**F2** Include in the output message a number of characters followed by an insert character. Start from the current cursor position and continue for “nn” characters or through the last character in the input message, followed by character “xx.” Syntax = *F2nnxx* where nn stands for the numeric value (00-99) for the number of characters, and xx stands for the insert character’s hex value for its ASCII code. Refer to the [ASCII Conversion Chart \(Code Page 1252\)](#), beginning on page 280 for decimal, hex and character codes.

### **F2 Example: Send a number of characters**



Send the first 10 characters from the barcode above, followed by a carriage return.  
Command string: F2100D

F2 is the “Send a number of characters” command

10 is the number of characters to send

0D is the hex value for a CR

The data is output as: **1234567890**

### **F2 and F1 Example: Split characters into 2 lines**

Send the first 10 characters from the barcode above, followed by a carriage return, followed by the rest of the characters.

Command string: **F2100DF10D**

F2 is the “Send a number of characters” command

10 is the number of characters to send for the first line

0D is the hex value for a CR

F1 is the “Send all characters” command

0D is the hex value for a CR

The data is output as:

**1234567890**  
**ABCDEFGHIJ**  
**<CR>**

## Send all characters up to a particular character

**F3** Include in the output message all characters from the input message, starting with the character at the current cursor position and continuing to, but not including, the search character “ss,” followed by an insert character. The cursor is moved forward to the “ss” character. *Syntax = F3ssxx* where ss stands for the search character’s hex value for its ASCII code, and xx stands for the insert character’s hex value for its ASCII code.

Refer to the [ASCII Conversion Chart \(Code Page 1252\)](#), beginning on page 280 for decimal, hex and character codes.

### **F3 Example: Send all characters up to a particular character**



Using the barcode above, send all characters up to but not including “D,” followed by a carriage return.

Command string: **F3440D**

F3 is the “Send all characters up to a particular character” command

44 is the hex value for a 'D’

0D is the hex value for a CR

The data is output as:

**1234567890ABC  
<CR>**

## Send all characters up to a string

**B9** Include in the output message all characters from the input message, starting with the character at the current cursor position and continuing to, but not including, the search string “s...s.” The cursor is moved forward to the beginning of the “s...s” string. *Syntax = B9nnns...s* where nnnn stands for the length of the string, and s...s stands for the string to be matched. The string is made up of hex values for the characters in the string. Refer to the [ASCII Conversion Chart \(Code Page 1252\)](#), beginning on page 280 for decimal, hex and character codes.

### **B9 Example: Send all characters up to a defined string**



Using the barcode above, send all characters up to but not including “AB.”

Command string: **B90024142**

B9 is the “Send all characters up to a string” command

0002 is the length of the string (2 characters)

41 is the hex value for A

42 is the hex value for B

The data is output as: **1234567890**

## Send all but the last characters

**E9** Include in the output message all but the last “nn” characters, starting from the current cursor position. The cursor is moved forward to one position past the last input message character included. *Syntax = E9nn* where nn stands for the numeric value (00-99) for the number of characters that will not be sent at the end of the message.

## Insert a character multiple times

**F4** Send “xx” character “nn” times in the output message, leaving the cursor in the current position. *Syntax = F4xxnn* where xx stands for the insert character’s hex value for its ASCII code, and nn is the numeric value (00-99) for the number of times it should be sent. Refer to the [ASCII Conversion Chart \(Code Page 1252\)](#), beginning on page 280 for decimal, hex and character codes.

**E9 and F4 Example: Send all but the last characters, followed by 2 tabs**



Send all characters except for the last 8 from the barcode above, followed by 2 tabs.

Command string: **E908F40902**

E9 is the “Send all but the last characters” command

08 is the number of characters at the end to ignore

F4 is the “Insert a character multiple times” command

09 is the hex value for a horizontal tab

02 is the number of times the tab character is sent

The data is output as: **1234567890AB <tab><tab>**

## Insert a string

**BA** Send “ss” string of “nn” length in the output message, leaving the cursor in the current position. *Syntax = BAnnnns...s* where nnnn stands for the length of the string, and s...s stands for the string. The string is made up of hex values for the characters in the string. Refer to the [ASCII Conversion Chart \(Code Page 1252\)](#), beginning on page 280 for decimal, hex and character codes.

**B9 and BA Example: Look for the string “AB” and insert 2 asterisks (\*\*)**



Using the barcode above, send all characters up to but not including “AB.” Insert 2 asterisks at that point, and send the rest of the data with a carriage return after.

Command string: **B900024142BA00022A2AF10D**

B9 is the “Send all characters up to a string” command

0002 is the length of the string (2 characters)

41 is the hex value for A

42 is the hex value for B

BA is the “Insert a string” command

0002 is the length of the string to be added (2 characters)

2A is the hex value for an asterisk (\*)

2A is the hex value for an asterisk (\*)

F1 is the “Send all characters” command

0D is the hex value for a CR

The data is output as:

**1234567890\*\*ABCDEFGHIJ**  
**<CR>**

## Insert symbology name

**B3** Insert the name of the barcode symbology in the output message, without moving the cursor. Only symbologies with a Honeywell ID are included (see [Symbology Charts](#) on page 277). Refer to the [ASCII Conversion Chart \(Code Page 1252\)](#), beginning on page 280 for decimal, hex and character codes.

## Insert barcode length

**B4** Insert the barcode length in the output message, without moving the cursor. The length is expressed as a numeric string and does not include leading zeros.

**B3 and B4 Example: Insert the symbology name and length**



Send the symbology name and length before the barcode data from the barcode above. Break up these insertions with spaces. End with a carriage return.

Command string: **B3F42001B4F42001F10D**

B3 is the “Insert symbology name” command  
 F4 is the “Insert a character multiple times” command  
 20 is the hex value for a space  
 01 is the number of times the space character is sent  
 B4 is the “Insert barcode length” command  
 F4 is the “Insert a character multiple times” command  
 20 is the hex value for a space  
 01 is the number of times the space character is sent  
 F1 is the “Send all characters” command  
 0D is the hex value for a CR

The data is output as:  
**Code128 20 1234567890ABCDEFGHIJ**  
**<CR>**

## Insert key strokes

**B5** Insert a key stroke or combination of key strokes. Key strokes are dependent on your keyboard (see [Keyboard Key References](#) on page 286). Any key can be inserted, including arrows and functions. *Syntax* = 5CB5xxssnn where xx is the number of keys pressed (without key modifiers), ss is the key modifier from the table below, and nn is the key number from the [Keyboard Key References](#), page 286.

Key Modifiers	Hex
No Key Modifier	00
Shift Left	01
Shift Right	02
Alt Left	04
Alt Right	08
Control Left	10
Control Right	20

For example, B501021F inserts an “A” on a 104 key, U.S. style keyboard. B5 = the command, 01 = number of key press events (without the key modifier), 02 is the key modifier for Shift Right, and 1F is the “a” key. If a lower case “a” were to be inserted, B501001F would be entered.

If there are three keystrokes, the syntax would change from B5xxssnn for one key-stroke to B5xxssnnssnnssnn. An example that would insert "abc" is as follows: B503001F00320030F833.

**Note:** *Key modifiers can be added together when needed. The sum is converted to hexadecimals.*

**Example:** Control Left+Shift Left = 17, converted to hexadecimal = 11.

# Move Commands

## Move the cursor forward a number of characters

**F5** Move the cursor ahead “nn” characters from current cursor position.  
*Syntax = F5nn* where nn is the numeric value (00-99) for the number of characters the cursor should be moved ahead.

**F5 Example: Move the cursor forward and send the data**



Move the cursor forward 3 characters, then send the rest of the barcode data from the barcode above. End with a carriage return.

Command string: **F503F10D**

F5 is the “Move the cursor forward a number of characters” command

03 is the number of characters to move the cursor

F1 is the “Send all characters” command

0D is the hex value for a CR

The data is output as:

**4567890ABCDEFGHIJ**

**<CR>**

## Move the cursor backward a number of characters

**F6** Move the cursor back “nn” characters from current cursor position.  
*Syntax = F6nn* where nn is the numeric value (00-99) for the number of characters the cursor should be moved back.

## Move the cursor to the beginning

**F7** Move the cursor to the first character in the input message. *Syntax = F7.*

**FE and F7 Example: Manipulate barcodes that begin with a 1**



Search for barcodes that begin with a 1. If a barcode matches, move the cursor back to the beginning of the data and send 6 characters followed by a carriage return. Using the barcode above:

Command string: **FE31F7F2060D**

FE is the “Compare characters” command

31 is the hex value for 1



F7 is the “Move the cursor to the beginning” command

F2 is the “Send a number of characters” command

06 is the number of characters to send

0D is the hex value for a CR

The data is output as:

**123456**

**<CR>**

## Move the cursor to the end

**EA** Move the cursor to the last character in the input message. *Syntax = EA.*

## Search Commands

### Search forward for a character

**F8** Search the input message forward for “xx” character from the current cursor position, leaving the cursor pointing to the “xx” character. *Syntax = F8xx* where xx stands for the search character’s hex value for its ASCII code. Refer to the [ASCII Conversion Chart \(Code Page 1252\)](#), beginning on page 280 for decimal, hex and character codes.

**F8 Example: Send barcode data that starts after a particular character**



Search for the letter “D” in barcodes and send all the data that follows, including the “D.” Using the barcode above:

Command string: **F844F10D**

F8 is the “Search forward for a character” command

44 is the hex value for “D”

F1 is the “Send all characters” command

0D is the hex value for a CR

The data is output as:

**DEFGHIJ**

**<CR>**

## Search backward for a character

- F9** Search the input message backward for “xx” character from the current cursor position, leaving the cursor pointing to the “xx” character. *Syntax = F9xx* where xx stands for the search character’s hex value for its ASCII code. Refer to the [ASCII Conversion Chart \(Code Page 1252\)](#), beginning on page 280 for decimal, hex and character codes.

## Search forward for a string

- B0** Search forward for “s” string from the current cursor position, leaving cursor pointing to “s” string. *Syntax = B0nnnnS* where nnnn is the string length (up to 9999), and S consists of the ASCII hex value of each character in the match string. For example, B0000454657374 will search forward for the first occurrence of the 4 character string “Test.” Refer to the [ASCII Conversion Chart \(Code Page 1252\)](#), beginning on page 280 for decimal, hex and character codes.

### **B0 Example: Send barcode data that starts after a string of characters**



Search for the letters “FGH” in barcodes and send all the data that follows, including “FGH.” Using the barcode above:

Command string: **B00003464748F10D**

B0 is the “Search forward for a string” command

0003 is the string length (3 characters)

46 is the hex value for “F”

47 is the hex value for “G”

48 is the hex value for “H”

F1 is the “Send all characters” command

0D is the hex value for a CR

The data is output as:

**FGHIJ**  
**<CR>**

## Search backward for a string

**B1** Search backward for “s” string from the current cursor position, leaving cursor pointing to “s” string. Syntax = B1nnnnS where nnnn is the string length (up to 9999), and S consists of the ASCII hex value of each character in the match string. For example, B1000454657374 will search backward for the first occurrence of the 4 character string “Test.”

Refer to the [ASCII Conversion Chart \(Code Page 1252\)](#), beginning on page 280 for decimal, hex and character codes.

## Search forward for a non-matching character

**E6** Search the input message forward for the first non-“xx” character from the current cursor position, leaving the cursor pointing to the non-“xx” character. Syntax = E6xx where xx stands for the search character’s hex value for its ASCII code. Refer to the [ASCII Conversion Chart \(Code Page 1252\)](#), beginning on page 280 for decimal, hex and character codes.

### **E6 Example: Remove zeros at the beginning of barcode data**



This example shows a barcode that has been zero filled. You may want to ignore the zeros and send all the data that follows. E6 searches forward for the first character that is not zero, then sends all the data after, followed by a carriage return. Using the barcode above:

Command string: **E630F10D**

E6 is the “Search forward for a non-matching character” command

30 is the hex value for 0

F1 is the “Send all characters” command

0D is the hex value for a CR

The data is output as:

**37692**

**<CR>**

## Search backward for a non-matching character

**E7** Search the input message backward for the first non-“xx” character from the current cursor position, leaving the cursor pointing to the non-“xx” character. Syntax = E7xx where xx stands for the search character’s hex value for its ASCII code. Refer to the [ASCII Conversion Chart \(Code Page 1252\)](#), beginning on page 280 for decimal, hex and character codes.

# Miscellaneous Commands

## Suppress characters

**FB** Suppress all occurrences of up to 15 different characters, starting at the current cursor position, as the cursor is advanced by other commands. When the FC command is encountered, the suppress function is terminated. The cursor is not moved by the FB command.

Syntax = FBnnxxyy ..zz where nn is a count of the number of suppressed characters in the list, and xxyy .. zz is the list of characters to be suppressed.

### **FB Example: Remove spaces in barcode data**



This example shows a barcode that has spaces in the data. You may want to remove the spaces before sending the data. Using the barcode above:

Command string: **FB0120F10D**

FB is the “Suppress characters” command

01 is the number of character types to be suppressed

20 is the hex value for a space

F1 is the “Send all characters” command

0D is the hex value for a CR

The data is output as:

**34567890**

**<CR>**

## Stop suppressing characters

**FC** Disables suppress filter and clear all suppressed characters. *Syntax = FC.*

## Replace characters

**E4** Replaces up to 15 characters in the output message, without moving the cursor. Replacement continues until the E5 command is encountered. *Syntax = E4nnxx<sub>1</sub>xx<sub>2</sub>yy<sub>1</sub>yy<sub>2</sub>...zz<sub>1</sub>zz<sub>2</sub>* where nn is the total count of the number of characters in the list (characters to be replaced plus replacement characters); xx<sub>1</sub> defines characters to be replaced and xx<sub>2</sub> defines replacement characters, continuing through zz<sub>1</sub> and zz<sub>2</sub>.

### **E4 Example: Replace zeros with CRs in barcode data**



If the barcode has characters that the host application does not want included, you can use the E4 command to replace those characters with something else. In this example, you will replace the zeros in the barcode above with carriage returns.

Command string: **E402300DF10D**

E4 is the “Replace characters” command

02 is the total count of characters to be replaced, plus the replacement characters (0 is replaced by CR, so total characters = 2)

30 is the hex value for 0

0D is the hex value for a CR (the character that will replace the 0)

F1 is the “Send all characters” command

0D is the hex value for a CR

The data is output as:

**1234**

**5678**

**ABC**

**<CR>**

## Stop replacing characters

**E5** Terminates character replacement. *Syntax = E5.*

## Compare characters

**FE** Compare the character in the current cursor position to the character “xx.” If characters are equal, move the cursor forward one position. *Syntax = FExx* where xx stands for the comparison character’s hex value for its ASCII code.

Refer to the [ASCII Conversion Chart \(Code Page 1252\)](#), beginning on page 280 for decimal, hex and character codes.

## Compare string

**B2** Compare the string in the input message to the string “s.” If the strings are equal, move the cursor forward past the end of the string. *Syntax = B2nnnnS* where nnnn is the string length (up to 9999), and S consists of the ASCII hex value of each character in the match string. For example, B2000454657374 will compare the string at the current cursor position with the 4 character string “Test.”

Refer to the [ASCII Conversion Chart \(Code Page 1252\)](#), beginning on page 280 for decimal, hex and character codes.

## Check for a number

**EC** Check to make sure there is an ASCII number at the current cursor position. The format is aborted if the character is not numeric.

### **EC Example: Only output the data if the barcode begins with a number**

If you want only data from barcodes that begin with a number, you can use EC to check for the number.

Command string: **ECF10D**

EC is the “Check for a number” command

F1 is the “Send all characters” command

0D is the hex value for a CR

If this barcode is read,  the next data format, if there is one, will be used on the data. If there is no other format, the format fails and the raw data is output as **AB1234**.

If this barcode is read:  the data is output as:

**1234AB**  
<CR>

## Check for non-numeric character

**ED** Check to make sure there is a non-numeric ASCII character at the current cursor position. The format is aborted if the character is numeric.

### **ED Example: Only output the data if the barcode begins with a letter**

If you want only data from barcodes that begin with a letter, you can use ED to check for the letter.

Command string: **EDF10D**

ED is the “Check for a non-numeric character” command

F1 is the “Send all characters” command

0D is the hex value for a CR

If this barcode is read,  the next data format, if there is one, will be used on this data. If there is no other format, the format fails and the raw data is output as **1234AB**.

If this barcode is read:  the data is output as:

**AB1234**  
<CR>

## Insert a delay

**EF** Inserts a delay of up to 49,995 milliseconds (in multiples of 5), starting from the current cursor position. Syntax = EFnnnn where nnnn stands for the delay in 5ms increments, up to 9999. This command can only be used with keyboard emulation.

## Discard Data

**B8** Discards types of data. For example, you may want to discard Code 128 barcodes that begin with the letter A. In step 4 ([page 120](#)), select 6A (for Code 128), and in step 5, select 9999 (for all lengths). Enter FE41B8 to compare and discard Code 128 barcodes that begin with the letter A. Syntax = B8.

**Note:** The B8 command must be entered after all other commands.

The Data Format must be **Required** (see [page 135](#)) in order for the B8 command to work.

If Data Format is On, but Not Required ([page 136](#)), barcode data that meets the B8 format is scanned and output as usual.

Because the data format needs to be **On** and **Required** ([page 136](#)) for the B8 command, you must input data formats for all barcodes you wish to discard as well as all barcodes you wish to output.

Other data format settings impact the B8 command. If Data Format Non-Match Error Tone is On ([page 136](#)), the scanner emits an error tone. If Data format Non-Match Error Tone is Off, the code is disabled for reading and no tone is sounded.

## Data Formatter

When Data Formatter is turned Off, the barcode data is output to the host as read, including prefixes and suffixes.



You may wish to require the data to conform to a data format you have created and saved. The following settings can be applied to your data format:

- **Data Formatter On, Not Required, Keep Prefix/Suffix**  
Scanned data is modified according to your data format, and prefixes and suffixes are transmitted.
- **Data Formatter On, Not Required, Drop Prefix/Suffix**  
Scanned data is modified according to your data format. If a data format is found for a particular symbol, those prefixes and suffixes are not transmitted. If a data format is *not* found for that symbol, the prefixes and suffixes are transmitted.
- **Data Format Required, Keep Prefix/Suffix**  
Scanned data is modified according to your data format, and prefixes and suffixes are transmitted. Any data that does not match your data format

requirements generates an error tone and the data in that barcode is not transmitted. If you wish to process this type of barcode without generating an error tone, see [Data Format Non-Match Error Tone](#).

- **Data Format Required, Drop Prefix/Suffix**  
Scanned data is modified according to your data format. If a data format is found for a particular symbol, those prefixes and suffixes are not transmitted. Any data that does not match your data format requirements generates an error tone. If you wish to process this type of barcode without generating an error tone, see [Data Format Non-Match Error Tone](#).

Choose one of the following options. *Default = Data Formatter On, Not Required, Keep Prefix/Suffix.*



DFM\_EN1.

\* Data Formatter On,  
Not Required,  
Keep Prefix/Suffix



DFM\_EN3.

Data Formatter On,  
Not Required,  
Drop Prefix/Suffix



DFM\_EN2.

Data Format Required,  
Keep Prefix/Suffix



DFM\_EN4.

Data Format Required,  
Drop Prefix/Suffix

## Data Format Non-Match Error Tone

When a barcode is encountered that doesn't match your required data format, the scanner normally generates an error tone. However, you may want to continue scanning barcodes without hearing the error tone. If you scan the **Data Format Non-Match Error Tone Off** barcode, data that doesn't conform to your data format is not transmitted, and no error tone will sound. If you wish to hear the error tone when a non-matching barcode is found, scan the **Data Format Non-Match Error Tone On** barcode. *Default = Data Format Non-Match Error Tone On.*



DFMDEC0.

\* Data Format Non-Match Error  
Tone On





## Primary/Alternate Data Formats

You can save up to four data formats, and switch between these formats. Your primary data format is saved under **0**. Your other three formats are saved under **1**, **2**, and **3**. To set your device to use one of these formats, scan one of the barcodes below.



## Single Scan Data Format Change

You can also switch between data formats for a single scan. The next barcode is scanned using an alternate data format, then reverts to the format you have selected above (either Primary, 1, 2, or 3).

For example, you may have set your device to the data format you saved as Data Format 3. You can switch to Data Format 1 for a single trigger pull by scanning the **Single Scan-Data Format 1** barcode below. The next barcode that is scanned uses Data Format 1, then reverts back to Data Format 3.

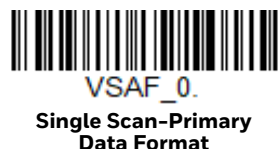



VSAF\_2.

Single Scan-Data Format 2



VSAF\_1.

Single Scan-Data Format 1



VSAF\_3.

Single Scan-Data Format 3

## SYMBOLOLOGIES

This programming section contains the following menu selections. Refer to [Chapter 10](#) for settings and defaults.

- All Symbolologies
- Aztec Code
- China Post (Hong Kong 2 of 5)
- Chinese Sensible (Han Xin) Code
- Codabar
- Codablock A
- Codablock F
- Code 11
- Code 128
- Code 32 Pharmaceutical (PARAF)
- Code 39
- Code 93
- Data Matrix
- Digimarc Barcode™
- DotCode
- EAN/JAN-13
- EAN/JAN-8
- GS1 Composite Codes
- GS1 DataBar Expanded
- GS1 DataBar Limited
- GS1 DataBar Omnidirectional
- GS1 Emulation
- GS1-128
- Interleaved 2 of 5
- Korea Post
- Label Code
- Matrix 2 of 5
- MaxiCode
- MicroPDF417
- MSI
- NEC 2 of 5
- Postal Codes - 2D
- Postal Codes - Linear
- PDF417
- QR Code
- Straight 2 of 5 IATA (two-bar start/stop)
- Straight 2 of 5 Industrial (three-bar start/stop)
- TCIF Linked Code 39 (TLC39)
- Telepen
- Trioptic Code
- UPC-A
- UPC-A/EAN-13 with Extended Coupon Code
- UPC-E0
- UPC-E1

# All Symbologies

For best scanner performance, you should only enable the symbologies that you need. Scan **All Symbologies Off** to disable all symbologies, then enable the symbologies you need by scanning the **On** barcode for each symbology.



## Message Length Description

You are able to set the valid reading length of some of the barcode symbologies. You may wish to set the same value for minimum and maximum length to force the scanner to read fixed length barcode data. This helps reduce the chances of a mis-read.

**Example:** Decode only those barcodes with a count of 9-20 characters.  
Min. length = 09  
Max. length = 20

**Example:** Decode only those barcodes with a count of 15 characters.  
Min. length = 15  
Max. length = 15

For a value other than the minimum and maximum message length defaults, scan the barcodes included in the explanation of the symbology, then scan the digit value of the message length and **Save** barcodes from the [Programming Chart](#), beginning on page 289. The minimum and maximum lengths and the defaults are included with the respective symbologies.

## Codabar

<Default All Codabar Settings>



## Codabar On/Off

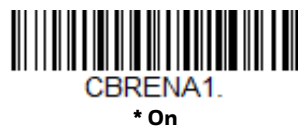



## Codabar Start / Stop Characters

Start/Stop characters identify the leading and trailing ends of the barcode. You may either transmit, or not transmit Start/Stop characters. *Default = Don't Transmit.*



## Codabar Check Character

Codabar check characters are created using different “modulos.” You can program the scanner to read only Codabar barcodes with Modulo 16 check characters. *Default = No Check Character.*

**No Check Character** indicates that the scanner reads and transmits barcode data with or without a check character.

When Check Character is set to **Validate and Transmit**, the scanner will only read Codabar barcodes printed with a check character, and will transmit this character at the end of the scanned data.

When Check Character is set to **Validate, but Don't Transmit**, the unit will only read Codabar barcodes printed *with* a check character, but will not transmit the check character with the scanned data.



# Codabar Concatenation

Codabar supports symbol concatenation. When you enable concatenation, the scanner looks for a Codabar symbol having a “D” start character, adjacent to a symbol having a “D” stop character. In this case the two messages are concatenated into one with the “D” characters omitted.



Select **Require** to prevent the scanner from decoding a single “D” Codabar symbol without its companion. This selection has no effect on Codabar symbols without Stop/Start D characters.



# Codabar Message Length

Scan the barcodes below to change the message length. Refer to [Message Length Description](#) (page 140) for additional information. Minimum and Maximum lengths = 2-60. Minimum Default = 4, Maximum Default = 60.



# Code 39

< Default All Code 39 Settings >



## Code 39 On/Off



If you are reading Code 39 barcodes, Codablock A should remain disabled. If you are enabling Codablock A (see [Codablock A](#) on page 179), you should disable Code 39.

## Code 39 Start/Stop Characters

Start/Stop characters identify the leading and trailing ends of the barcode. You may either transmit, or not transmit Start/Stop characters. *Default = Don't Transmit.*



## Code 39 Check Character

**No Check Character** indicates that the scanner reads and transmits barcode data with or without a check character.

When Check Character is set to **Validate, but Don't Transmit**, the unit only reads Code 39 barcodes printed with a check character, but will not transmit the check character with the scanned data.

When Check Character is set to **Validate and Transmit**, the scanner only reads Code 39 barcodes printed with a check character, and will transmit this character at the end of the scanned data. *Default = No Check Character.*



## Code 39 Message Length

Scan the barcodes below to change the message length. Refer to [Message Length Description](#) (page 140) for additional information. Minimum and Maximum lengths = 0-48. Minimum Default = 0, Maximum Default = 48.



## Code 39 Append

This function allows the scanner to append the data from several Code 39 barcodes together before transmitting them to the host computer. When the scanner encounters a Code 39 barcode with the append trigger character(s), it buffers Code 39 barcodes until it reads a Code 39 barcode that does not have the append trigger. The data is then transmitted in the order in which the barcodes were read (FIFO). *Default = Off.*





# Code 32 Pharmaceutical (PARAF)

Code 32 Pharmaceutical is a form of the Code 39 symbology used by Italian pharmacies. This symbology is also known as PARAF.

**Note:** *Trioptic Code (page 178) must be turned off while scanning Code 32 Pharmaceutical codes.*



## Full ASCII

If Full ASCII Code 39 decoding is enabled, certain character pairs within the barcode symbol will be interpreted as a single character. For example: \$V will be decoded as the ASCII character SYN, and /C will be decoded as the ASCII character #. *Default = Off.*

Full ASCII Table											
NUL %U	DLE \$P	SP SPACE	0 0	@ %V	P P	' %W	p +P				
SOH \$A	DC1 \$Q	! /A	1 1	A A	Q Q	a +A	q +Q				
STX \$B	DC2 \$R	" /B	2 2	B B	R R	b +B	r +R				
ETX \$C	DC3 \$S	# /C	3 3	C C	S S	c +C	s +S				
EOT \$D	DC4 \$T	\$ /D	4 4	D D	T T	d +D	t +T				
ENQ \$E	NAK \$U	% /E	5 5	E E	U U	e +E	u +U				
ACK \$F	SYN \$V	& /F	6 6	F F	V V	f +F	v +V				
BEL \$G	ETB \$W	' /G	7 7	G G	W W	g +G	w +W				
BS \$H	CAN \$X	( /H	8 8	H H	X X	h +H	x +X				
HT \$I	EM \$Y	) /I	9 9	I I	Y Y	i +I	y +Y				
LF \$J	SUB \$Z	* /J	: /Z	J J	Z Z	j +J	z +Z				
VT \$K	ESC %A	+ /K	; %F	K K	[ %K	k +K	{ %P				
FF \$L	FS %B	, /L	< %G	L L	\ %L	l +L	%Q				
CR \$M	GS %C	- /M	= %H	M M	] %M	m +M	} %R				
SO \$N	RS %D	. /N	> %I	N N	^ %N	n +N	~ %S				
SI \$O	US %E	/ /O	? %J	O O	_ %O	o +O	DEL %T				

Character pairs /M and /N decode as a minus sign and period respectively.  
Character pairs /P through /Y decode as 0 through 9.



## Code 39 Code Page

Code pages define the mapping of character codes to characters. If the data received does not display with the proper characters, it may be because the barcode being scanned was created using a code page that is different from the one the host program is expecting. If this is the case, scan the barcode below, select the code page with which the barcodes were created (see [ISO 2022/ISO 646 Character Replacements](#) on page 284), and scan the value and the **Save** barcode from the [Programming Chart](#), beginning on page 289. The data characters should then appear properly.



C39DCP.  
Code 39 Code Page

## Interleaved 2 of 5

< Default All Interleaved 2 of 5 Settings >



I25DFT.

## Interleaved 2 of 5 On/Off



I25ENA1.

\* On



I25ENA0.

Off

## Check Digit

**No Check Digit** indicates that the scanner reads and transmits barcode data with or without a check digit.

When Check Digit is set to **Validate, but Don't Transmit**, the unit only reads Interleaved 2 of 5 barcodes printed with a check digit, but will not transmit the check digit with the scanned data.

When Check Digit is set to **Validate and Transmit**, the scanner only reads Interleaved 2 of 5 barcodes printed with a check digit, and will transmit this digit at the end of the scanned data. *Default = No Check Digit.*



## Interleaved 2 of 5 Message Length

Scan the barcodes below to change the message length. Refer to [Message Length Description](#) (page 140) for additional information. Minimum and Maximum lengths = 2-80. Minimum Default = 6, Maximum Default = 80.



## FEBRABAN Decode

Scan the barcodes below to turn FEBRABAN Boleto decoding on or off. *Default = Off.*



# NEC 2 of 5

< Default All NEC 2 of 5 Settings >



## NEC 2 of 5 On/Off



## Check Digit

**No Check Digit** indicates that the scanner reads and transmits barcode data with or without a check digit.

When Check Digit is set to **Validate, but Don't Transmit**, the unit only reads NEC 2 of 5 barcodes printed with a check digit, but will not transmit the check digit with the scanned data.

When Check Digit is set to **Validate and Transmit**, the scanner only reads NEC 2 of 5 barcodes printed with a check digit, and will transmit this digit at the end of the scanned data. *Default = No Check Digit.*



## NEC 2 of 5 Message Length

Scan the barcodes below to change the message length. Refer to [Message Length Description](#) (page 140) for additional information. Minimum and Maximum lengths = 2-80. Minimum Default = 4, Maximum Default = 80.



## Code 93

< Default All Code 93 Settings >



## Code 93 On/Off



## Code 93 Message Length

Scan the barcodes below to change the message length. Refer to [Message Length Description](#) (page 140) for additional information. Minimum and Maximum lengths = 0-80. Minimum Default = 0, Maximum Default = 80.



## Code 93 Append

This function allows the scanner to append the data from several Code 93 barcodes together before transmitting them to the host computer. When this function is enabled, the scanner stores those Code 93 barcodes that start with a space (excluding the start and stop symbols), and does not immediately transmit the data. The scanner stores the data in the order in which the barcodes are read, deleting the first space from each. The scanner transmits the appended data when it reads a Code 93 barcode that starts with a character other than a space. *Default = Off.*



C93APP1.

On



C93APP0.

\* Off

## Code 93 Code Page

Code pages define the mapping of character codes to characters. If the data received does not display with the proper characters, it may be because the barcode being scanned was created using a code page that is different from the one the host program is expecting. If this is the case, scan the barcode below, select the code page with which the barcodes were created (see [ISO 2022/ISO 646 Character Replacements](#) on page 284), and scan the value and the **Save** barcode from the [Programming Chart](#), beginning on page 289. The data characters should then appear properly.



C93DCP.

Code 93 Code Page

# Straight 2 of 5 Industrial (three-bar start/stop)

<Default All Straight 2 of 5 Industrial Settings>



R25DFT.

## Straight 2 of 5 Industrial On/Off



R25ENA1.

On



R25ENA0.

\* Off

## Straight 2 of 5 Industrial Message Length

Scan the barcodes below to change the message length. Refer to [Message Length Description](#) (page 140) for additional information. Minimum and Maximum lengths = 1-48. Minimum Default = 4, Maximum Default = 48.



R25MIN.

Minimum Message Length



R25MAX.

Maximum Message Length

# Straight 2 of 5 IATA (two-bar start/stop)

<Default All Straight 2 of 5 IATA Settings>



## Straight 2 of 5 IATA On/Off



## Straight 2 of 5 IATA Redundancy

If you are encountering errors when reading Straight 2 of 5 IATA barcodes, you may want to adjust the redundancy count. Redundancy adjusts the number of times a barcode is decoded before transmission, which may reduce the number of errors. Note that the higher the redundancy count, the longer it will take to decode the barcode. To adjust the redundancy, scan the Straight 2 of 5 IATA Redundancy barcode below, then scan a redundancy count between 0 and 10 on the [Programming Chart](#), beginning on page 289. Then scan the **Save** barcode. *Default = 0.*



## Straight 2 of 5 IATA Message Length

Scan the barcodes below to change the message length. Refer to [Message Length Description](#) (page 140) for additional information. Minimum and Maximum lengths = 1-48. Minimum Default = 4, Maximum Default = 48.





# Matrix 2 of 5

<Default All Matrix 2 of 5 Settings>



## Matrix 2 of 5 On/Off



## Matrix 2 of 5 Message Length

Scan the barcodes below to change the message length. Refer to [Message Length Description](#) (page 140) for additional information. Minimum and Maximum lengths = 1-80. Minimum Default = 4, Maximum Default = 80.



# Code 11

<Default All Code 11 Settings>



## Code 11 On/Off



## Check Digits Required

This option sets whether 1 or 2 check digits are required with Code 11 barcodes.  
*Default = Two Check Digits.*



## Code 11 Message Length

Scan the barcodes below to change the message length. Refer to [Message Length Description](#) (page 140) for additional information. Minimum and Maximum lengths = 1-80. Minimum Default = 4, Maximum Default = 80.



# Code 128

<Default All Code 128 Settings>



## Code 128 On/Off



If you are reading Code 128 barcodes, Codablock F should remain disabled. If you are enabling Codablock F (see [Codablock F](#) on page 180), you should disable Code 128.

## ISBT 128 Concatenation

In 1994 the International Society of Blood Transfusion (ISBT) ratified a standard for communicating critical blood information in a uniform manner. The use of ISBT formats requires a paid license. The ISBT 128 Application Specification describes 1) the critical data elements for labeling blood products, 2) the current recommendation to use Code 128 due to its high degree of security and its space-efficient design, 3) a variation of Code 128 that supports concatenation of neighboring symbols, and 4) the standard layout for barcodes on a blood product label. Use the barcodes below to turn concatenation on or off. *Default =Off.*



## Code 128 Redundancy

If you are encountering errors when reading Code 128 barcodes, you may want to adjust the redundancy count. Redundancy adjusts the number of times a barcode is decoded before transmission, which may reduce the number of errors. Note that

the higher the redundancy count, the longer it will take to decode the barcode. To adjust the redundancy, scan the Code 128 Redundancy barcode below, then scan a redundancy count between 0 and 10 on the [Programming Chart](#), beginning on page 289. Then scan the **Save** barcode. *Default = 0.*



128VOT.

**Code 128 Redundancy**

## Code 128 Message Length

Scan the barcodes below to change the message length. Refer to [Message Length Description](#) (page 140) for additional information. Minimum and Maximum lengths = 0-80. Minimum Default = 0, Maximum Default = 80.



128MIN.

**Minimum Message Length**



128MAX.

**Maximum Message Length**

## Code 128 Append

This function allows the scanner to append the data from several Code 128 barcodes together before transmitting them to the host computer. When the scanner encounters a Code 128 barcode with the append trigger character(s), it buffers Code 128 barcodes until it reads a Code 128 barcode that does not have the append trigger. The data is then transmitted in the order in which the barcodes were read (FIFO). *Default = Off.*



128APP1.

**On**



128APP0.

**\* Off**

## Code 128 Code Page

Code pages define the mapping of character codes to characters. If the data received does not display with the proper characters, it may be because the barcode being scanned was created using a code page that is different from the one the host program is expecting. If this is the case, scan the barcode below, select the code page with which the barcodes were created (see [ISO 2022/ISO 646 Character](#)

Replacements on page 284), and scan the value and the **Save** barcode from the Programming Chart, beginning on page 289. The data characters should then appear properly.



## GS1-128

<Default All GS1-128 Settings>



## GS1-128 On/Off



## GS1-128 Message Length

Scan the barcodes below to change the message length. Refer to [Message Length Description](#) (page 140) for additional information. Minimum and Maximum lengths = 1-80. Minimum Default = 1, Maximum Default = 80.



# Telepen

<Default All Telepen Settings>



## Telepen On/Off



## Telepen Output

Using **AIM Telepen Output**, the scanner reads symbols with start/stop pattern 1 and decodes them as standard full ASCII (start/stop pattern 1). When **Original Telepen Output** is selected, the scanner reads symbols with start/stop pattern 1 and decodes them as compressed numeric with optional full ASCII (start/stop pattern 2). *Default = AIM Telepen Output.*



## Telepen Message Length

Scan the barcodes below to change the message length. Refer to [Message Length Description](#) (page 140) for additional information. Minimum and Maximum lengths = 1-60. Minimum Default = 1, Maximum Default = 60.



# UPC-A

<Default All UPC-A Settings>



## UPC-A On/Off



**Note:** To convert UPC-A barcodes to EAN-13, see [Convert UPC-A to EAN-13](#) on page 166.

## UPC-A Check Digit

This selection allows you to specify whether the check digit should be transmitted at the end of the scanned data or not. *Default = On.*



## UPC-A Number System

The numeric system digit of a U.P.C. symbol is normally transmitted at the beginning of the scanned data, but can be programmed so it is not transmitted (**Off**).  
*Default = On.*



## UPC-A Addenda

This selection adds 2 or 5 digits to the end of all scanned UPC-A data.  
*Default = Off for both 2 Digit and 5 Digit Addenda.*



UPAAD21.  
2 Digit Addenda On



UPAAD20.  
\* 2 Digit Addenda Off



UPAAD51.  
5 Digit Addenda On



UPAAD50.  
\* 5 Digit Addenda Off

## UPC-A Addenda Required

When **Required** is scanned, the scanner will only read UPC-A barcodes that have addenda. You must then turn on a 2 or 5 digit addenda listed on [page 160](#).  
*Default = Not Required.*



UPAARQ1.  
Required



UPAARQ0.  
\* Not Required

## Addenda Timeout

You can set a time during which the scanner looks for an addenda. If an addenda is not found within this time period, the data can be either transmitted or discarded, based on the setting you are using for [UPC-A Addenda Required](#). Set the length (in milliseconds) for this timeout by scanning the barcode below, then setting the timeout (from 0-120 milliseconds) by scanning digits from the [Programming Chart](#), beginning on page 289 of this manual, then **Save**. *Default = 500.*

**Note:** *The Addenda Timeout setting is applied to all addenda and coupon code searches.*



DLYADD.  
Addenda Timeout



## UPC-A Addenda Separator

When this feature is **On**, there is a space between the data from the barcode and the data from the addenda. When turned **Off**, there is no space. *Default = On.*



UPAADS1.

\* On



UPAADS0.

Off

## UPC-A/EAN-13 with Extended Coupon Code

Use the following codes to enable or disable UPC-A and EAN-13 with Extended Coupon Code. When left on the default setting (**Off**), the scanner treats Coupon Codes and Extended Coupon Codes as single barcodes.

If you scan the **Allow Concatenation** code, when the scanner sees the coupon code and the extended coupon code in a single scan, it transmits both as one symbologies. Otherwise, it transmits the first coupon code it reads.

If you scan the **Require Concatenation** code, the scanner must see and read the coupon code and extended coupon code in a single read to transmit the data. No data is output unless both codes are read. *Default = Off.*



CPNENA0.

\* Off



CPNENA1.

Allow Concatenation



CPNENA2.

Require Concatenation

## Addenda Timeout

You can set a time during which the scanner looks for an addenda. If an addenda is not found within this time period, the data can be either transmitted or discarded, based on the setting you are using for [UPC-A/EAN-13 with Extended Coupon Code](#). Set the length (in milliseconds) for this timeout by scanning the barcode

below, then setting the timeout (from 0-120 milliseconds) by scanning digits from the [Programming Chart](#), beginning on page 289 of this manual, then **Save**. *Default = 500.*

**Note:** *The Addenda Timeout setting is applied to all addenda and coupon code searches.*



## Coupon GS1 DataBar Output

If you scan coupons that have both UPC and GS1 Databar codes, you may wish to scan and output only the data from the GS1 Databar code. Scan the **GS1 Output On** code below to scan and output only the GS1 Databar code data. *Default = GS1 Output Off.*



## UPC-E0

<Default All UPC-E Settings>



## UPC-E0 On/Off

Most U.P.C. barcodes lead with the 0 number system. To read these codes, use the **UPC-E0 On** selection. If you need to read codes that lead with the 1 number system, use [UPC-E1](#) (page 165). *Default = On.*



## UPC-E0 Expand

UPC-E Expand expands the UPC-E code to the 12 digit, UPC-A format.  
*Default = Off.*



UPEEXP1.

On



UPEEXP0.

\* Off

## UPC-E0 Addenda Required

When **Required** is scanned, the scanner will only read UPC-E barcodes that have addenda. *Default = Not Required.*



UPEARQ1.

Required



UPEARQ0.

\* Not Required

## Addenda Timeout

You can set a time during which the scanner looks for an addenda. If an addenda is not found within this time period, the data can be either transmitted or discarded, based on the setting you are using for [UPC-E0 Addenda Required](#). Set the length (in milliseconds) for this timeout by scanning the barcode below, then setting the timeout (from 0-120 milliseconds) by scanning digits from the [Programming Chart](#), beginning on page 289 of this manual, then **Save**. *Default = 500.*

**Note:** *The Addenda Timeout setting is applied to all addenda and coupon code searches.*



DLYADD.

Addenda Timeout

## UPC-E0 Addenda Separator

When this feature is **On**, there is a space between the data from the barcode and the data from the addenda. When turned **Off**, there is no space. *Default = On.*



## UPC-E0 Check Digit

Check Digit specifies whether the check digit should be transmitted at the end of the scanned data or not. *Default = On.*



## UPC-E0 Leading Zero

This feature allows the transmission of a leading zero (0) at the beginning of scanned data. To prevent transmission, scan **Off**. *Default = On.*



## UPC-E0 Addenda

This selection adds 2 or 5 digits to the end of all scanned UPC-E data. *Default = Off for both 2 Digit and 5 Digit Addenda.*



UPEAD21.

2 Digit Addenda On



UPEAD20.

\* 2 Digit Addenda Off



UPEAD51.

5 Digit Addenda On



UPEAD50.

\* 5 Digit Addenda Off

## UPC-E1

Most U.P.C. barcodes lead with the 0 number system. For these codes, use [UPC-E0](#) (page 162). If you need to read codes that lead with the 1 number system, use the **UPC-E1 On** selection. *Default = Off.*



UPEEN11.

UPC-E1 On



UPEEN10.

\* UPC-E1 Off

# EAN/JAN-13

<Default All EAN/JAN Settings>



## EAN/JAN-13 On/Off



## Convert UPC-A to EAN-13

When **UPC-A Converted to EAN-13** is selected, UPC-A barcodes are converted to 13 digit EAN-13 codes by adding a zero to the front. When **Do not Convert UPC-A** is selected, UPC-A codes are read as UPC-A.



## EAN/JAN-13 Check Digit

This selection allows you to specify whether the check digit should be transmitted at the end of the scanned data or not. *Default = On.*



## EAN/JAN-13 Addenda

This selection adds 2 or 5 digits to the end of all scanned EAN/JAN-13 data.  
*Default = Off for both 2 Digit and 5 Digit Addenda.*



E13AD21.  
2 Digit Addenda On



E13AD20.  
\* 2 Digit Addenda Off



E13AD51.  
5 Digit Addenda On



E13AD50.  
\* 5 Digit Addenda Off

## EAN/JAN-13 Addenda Required

When **Required** is scanned, the scanner will only read EAN/JAN-13 barcodes that have addenda. *Default = Not Required.*



E13ARQ1.  
Required



E13ARQ0.  
\* Not Required

## EAN-13 Beginning with 290 Addenda Required

This setting programs the scanner to require a 5 digit addenda only on EAN-13 barcodes that begin with “290.” The following settings can be programmed:

**Require 5 Digit Addenda:** All EAN-13 barcodes that begin with “290” must have a 5 digit addendum. The EAN-13 barcode with the 5 digit addendum is then transmitted as a single, concatenated barcode. If a 5 digit addendum is not found within the [Addenda Timeout](#) period, the EAN-13 barcode is discarded.

**Note:** *If you are using [EAN-13 Beginning with 290 Addenda Required](#) (page 167), this setting will take precedence.*

**Don't Require 5 Digit Addenda:** If you have selected Require 5 Digit Addenda, and you want to disable this feature, scan **Don't Require 5 Digit Addenda**. EAN-13 barcodes are transmitted, depending on the setting you are using for [EAN/JAN-13 Addenda Required](#).

*Default = Don't Require 5 Digit Addenda.*



\* Don't Require 5 Digit Addenda



## EAN-13 Beginning with 378/379 Addenda Required

This setting programs the scanner to require any combination of a 2 digit addenda or a 5 digit addenda on EAN-13 barcodes that begin with a "378" or "379." The following settings can be programmed:

**Require Addenda:** All EAN-13 barcodes that begin with a "378" or "379" must have a 2 digit addenda, a 5 digit addenda, or a combination of these addenda. The EAN-13 barcode with the addenda is then transmitted as a single, concatenated barcode. If the required addenda is not found within the [Addenda Timeout](#) period, the EAN-13 barcode is discarded.

**Don't Require Addenda:** If you have selected Require Addenda, and you want to disable this feature, scan **Don't Require Addenda**. EAN-13 barcodes are transmitted, depending on the setting you are using for [EAN/JAN-13 Addenda Required](#).

*Default = Don't Require Addenda.*



\* Don't Require Addenda



Require 5 Digit Addenda





## EAN-13 Beginning with 414/419 Addenda Required

This setting programs the scanner to require any combination of a 2 digit addenda or a 5 digit addenda on EAN-13 barcodes that begin with a “414” or “419.” The following settings can be programmed:

**Require Addenda:** All EAN-13 barcodes that begin with a “414” or “419” must have a 2 digit addenda, a 5 digit addenda, or a combination of these addenda. The EAN-13 barcode with the addenda is then transmitted as a single, concatenated barcode. If the required addenda is not found within the [Addenda Timeout](#) period, the EAN-13 barcode is discarded.

**Don't Require Addenda:** If you have selected Require Addenda, and you want to disable this feature, scan **Don't Require Addenda**. EAN-13 barcodes are transmitted, depending on the setting you are using for [EAN/JAN-13 Addenda Required](#).

*Default = Don't Require Addenda.*



ARQ4140.

\* Don't Require Addenda



ARQ4141.

Require 2 Digit Addenda



ARQ4142.

Require 5 Digit Addenda



ARQ4143.

Require 2 or 5 Digit Addenda

## EAN-13 Beginning with 434/439 Addenda Required

This setting programs the scanner to require any combination of a 2 digit addenda or a 5 digit addenda on EAN-13 barcodes that begin with a “434” or “439.” The following settings can be programmed:

**Require Addenda:** All EAN-13 barcodes that begin with a “434” or “439” must have a 2 digit addenda, a 5 digit addenda, or a combination of these addenda. The EAN-13 barcode with the addenda is then transmitted as a single, concatenated barcode. If the required addenda is not found within the [Addenda Timeout](#) period, the EAN-13 barcode is discarded.

**Don't Require Addenda:** If you have selected Require Addenda, and you want to disable this feature, scan **Don't Require Addenda**. EAN-13 barcodes are transmitted, depending on the setting you are using for [EAN/JAN-13 Addenda Required](#).

*Default = Don't Require Addenda.*



ARQ4340.

\* Don't Require Addenda



ARQ4341.

Require 2 Digit Addenda



ARQ4342.

Require 5 Digit Addenda



ARQ4343.

Require 2 or 5 Digit Addenda

## EAN-13 Beginning with 977 Addenda Required

This setting programs the scanner to require a 2 digit addenda only on EAN-13 barcodes that begin with “977.” The following settings can be programmed:

**Require 2 Digit Addenda:** All EAN-13 barcodes that begin with “977” must have a 2 digit addendum. The EAN-13 barcode with the 2 digit addendum is then transmitted as a single, concatenated barcode. If a 2 digit addendum is not found within the [Addenda Timeout](#) period, the EAN-13 barcode is discarded.

**Don't Require 2 Digit Addenda:** If you have selected Require 2 Digit Addenda, and you want to disable this feature, scan **Don't Require 2 Digit Addenda**. EAN-13 barcodes are transmitted, depending on the setting you are using for [EAN/JAN-13 Addenda Required](#).

*Default = Don't Require 2 Digit Addenda.*



ARQ9770.

\* Don't Require 2 Digit Addenda



ARQ9771.

Require 2 Digit Addenda

## EAN-13 Beginning with 978 Addenda Required

These settings program the scanner to require a 5 digit addenda only on EAN-13 barcodes that begin with “978.” The following settings can be programmed:

**Require 5 Digit Addenda:** All EAN-13 barcodes that begin with “978” must have a 5 digit addendum. The EAN-13 barcode with the 5 digit addendum is then transmitted as a single, concatenated barcode. If a 5 digit addendum is not found within the [Addenda Timeout](#) period, the EAN-13 barcode is discarded.

**Don’t Require 5 Digit Addenda:** If you have selected Require 5 Digit Addenda, and you want to disable this feature, scan **Don’t Require 5 Digit Addenda**. EAN-13 barcodes are transmitted, depending on the setting you are using for [EAN/JAN-13 Addenda Required](#).

*Default = Don’t Require 5 Digit Addenda.*



ARQ9780.

\* Don’t Require 5 Digit Addenda



ARQ9781.

Require 5 Digit Addenda

## EAN-13 Beginning with 979 Addenda Required

These settings program the scanner to require a 5 digit addenda only on EAN-13 barcodes that begin with “979.” The following settings can be programmed:

**Require 5 Digit Addenda:** All EAN-13 barcodes that begin with “979” must have a 5 digit addendum. The EAN-13 barcode with the 5 digit addendum is then transmitted as a single, concatenated barcode. If a 5 digit addendum is not found within the [Addenda Timeout](#) period, the EAN-13 barcode is discarded.

**Don’t Require 5 Digit Addenda:** If you have selected Require 5 Digit Addenda, and you want to disable this feature, scan **Don’t Require 5 Digit Addenda**. EAN-13 barcodes are transmitted, depending on the setting you are using for [EAN/JAN-13 Addenda Required](#).

*Default = Don’t Require 5 Digit Addenda.*



ARQ9790.

\* Don’t Require 5 Digit Addenda



ARQ9791.

Require 5 Digit Addenda

## Addenda Timeout

You can set a time during which the scanner looks for an addenda. If an addenda is not found within this time period, the data can be either transmitted or discarded, based on the setting you are using for [EAN/JAN-13 Addenda Required](#). Set the length (in milliseconds) for this timeout by scanning the barcode below, then setting the timeout (from 0-120 milliseconds) by scanning digits from the [Programming Chart](#), beginning on page 289 of this manual, then **Save**. *Default = 500.*

**Note:** *The Addenda Timeout setting is applied to all addenda and coupon code searches.*



## EAN/JAN-13 Addenda Separator

When this feature is On, there is a space between the data from the barcode and the data from the addenda. When turned Off, there is no space. *Default = On.*



**Note:** *If you want to enable or disable EAN13 with Extended Coupon Code, refer to [UPC-A/ EAN-13 with Extended Coupon Code](#) (page 161).*

## ISBN Translate

When **On** is scanned, EAN-13 Bookland symbols are translated into their equivalent ISBN number format. *Default = Off.*



# EAN/JAN-8

<Default All EAN/JAN-8 Settings>



## EAN/JAN-8 On/Off



## EAN/JAN-8 Check Digit

This selection allows you to specify whether or not the check digit should be transmitted at the end of the scanned data. *Default = On.*



## EAN/JAN-8 Addenda

This selection adds 2 or 5 digits to the end of all scanned EAN/JAN-8 data. *Default = Off for both 2 Digit and 5 Digit Addenda.*





## EAN/JAN-8 Addenda Required

When **Required** is scanned, the scanner will only read EAN/JAN-8 barcodes that have addenda. *Default = Not Required.*



## Addenda Timeout

You can set a time during which the scanner looks for an addenda. If an addenda is not found within this time period, the data can be either transmitted or discarded, based on the setting you are using for [EAN/JAN-8 Addenda Required](#). Set the length (in milliseconds) for this timeout by scanning the barcode below, then setting the timeout (from 0-120 milliseconds) by scanning digits from the [Programming Chart](#), beginning on page 289 of this manual, then **Save**. *Default = 500.*

**Note:** *The Addenda Timeout setting is applied to all addenda and coupon code searches.*



## EAN/JAN-8 Addenda Separator

When this feature is **On**, there is a space between the data from the barcode and the data from the addenda. When turned **Off**, there is no space. *Default = On.*





# MSI

<Default All MSI Settings>



## MSI On/Off



## MSI Check Character

Different types of check characters are used with MSI barcodes. You can program the scanner to read MSI barcodes with Type 10 check characters. *Default = Validate Type 10, but Don't Transmit.*

When Check Character is set to **Validate Type 10/11 and Transmit**, the scanner will only read MSI barcodes printed with the specified type check character(s), and will transmit the character(s) at the end of the scanned data.

When Check Character is set to **Validate Type 10/11, but Don't Transmit**, the unit will only read MSI barcodes printed with the specified type check character(s), but will not transmit the check character(s) with the scanned data.



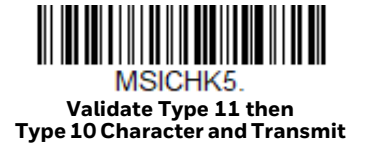
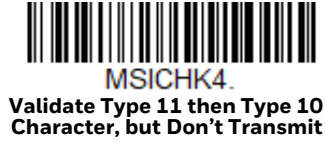

## MSI Message Length

Scan the barcodes below to change the message length. Refer to [Message Length Description](#) (page 140) for additional information. Minimum and Maximum lengths = 4-48. Minimum Default = 4, Maximum Default = 48.





# GS1 DataBar Omnidirectional

< Default All GS1 DataBar Omnidirectional Settings >



# GS1 DataBar Omnidirectional On/Off



# GS1 DataBar Limited

< Default All GS1 DataBar Limited Settings >



# GS1 DataBar Limited On/Off



# GS1 DataBar Expanded

< Default All GS1 DataBar Expanded Settings >



## GS1 DataBar Expanded On/Off



## GS1 DataBar Expanded Message Length

Scan the barcodes below to change the message length. Refer to [Message Length Description](#) (page 140) for additional information. Minimum and Maximum lengths = 4-74. Minimum Default = 4, Maximum Default = 74.



## Trioptic Code

**Note:** If you are going to scan Code 32 Pharmaceutical codes ([page 145](#)), Trioptic Code must be off.

Trioptic Code is used for labeling magnetic storage media.



# Codablock A

<Default All Codablock A Settings>



## Codablock A On/Off

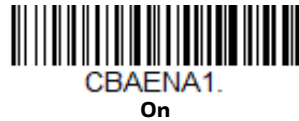

If you are reading Code 39 barcodes, Codablock A should remain disabled. If you are enabling Codablock A, you should disable Code 39 (see [Code 39](#) on page 143).

## Codablock A Message Length

Scan the barcodes below to change the message length. Refer to [Message Length Description](#) (page 140) for additional information. Minimum and Maximum lengths = 1-600. Minimum Default = 1, Maximum Default = 600.



# Codablock F

<Default All Codablock F Settings>



## Codablock F On/Off



If you are reading Code 128 barcodes, Codablock F should remain disabled. If you are enabling Codablock F, you should disable Code 128 (see [Code 128](#) on page 155).

## Codablock F Message Length

Scan the barcodes below to change the message length. Refer to [Message Length Description](#) (page 140) for additional information. Minimum and Maximum lengths = 1-2048. Minimum Default = 1, Maximum Default = 2048.



## Label Code

The standard Label Code is used in libraries. *Default = Off.*



# PDF417

< Default All PDF417 Settings >



## PDF417 On/Off



## PDF417 Message Length

Scan the barcodes below to change the message length. Refer to [Message Length Description](#) (page 140) for additional information. Minimum and Maximum lengths = 1-2750. Minimum Default = 1, Maximum Default = 2750.



## MacroPDF417

MacroPDF417 is an implementation of PDF417 capable of encoding very large amounts of data into multiple PDF417 barcodes. When this selection is enabled, these multiple barcodes are assembled into a single data string. *Default = On.*



# MicroPDF417

< Default All MicroPDF417 Settings >



## MicroPDF417 On/Off



## MicroPDF417 Message Length

Scan the barcodes below to change the message length. Refer to [Message Length Description](#) (page 140) for additional information. Minimum and Maximum lengths = 1-366. Minimum Default = 1, Maximum Default = 366.



## GS1 Composite Codes

Linear codes are combined with a unique 2D composite component to form a new class called GS1 Composite symbology. GS1 Composite symbologies allow for the co-existence of symbologies already in use. *Default = Off.*



## UPC/EAN Version

Scan the **UPC/EAN Version On** barcode to decode GS1 Composite symbols that have a U.P.C. or an EAN linear component. (This does not affect GS1 Composite symbols with a GS1-128 or GS1 linear component.) *Default = UPC/EAN Version Off.*



**Note:** *If you scan coupons that have both UPC and GS1 Databar codes, you may wish to scan and output only the data from the GS1 Databar code. See [Coupon GS1 DataBar Output](#) (page 162) for further information.*

## GS1 Composite Code Message Length

Scan the barcodes below to change the message length. Refer to [Message Length Description](#) (page 140) for additional information. Minimum and Maximum lengths = 1-2435. Minimum Default = 1, Maximum Default = 2435.



## GS1 Emulation

The scanner can automatically format the output from any GS1 data carrier to emulate what would be encoded in an equivalent GS1-128 or GS1 DataBar symbol. GS1 data carriers include UPC-A and UPC-E, EAN-13 and EAN-8, ITF-14, GS1-128, and GS1 DataBar and GS1 Composites. (Any application that accepts GS1 data can be simplified since it only needs to recognize one data carrier type.)

If **GS1-128 Emulation** is scanned, all retail codes (U.P.C., UPC-E, EAN8, EAN13) are expanded out to 16 digits. If the **AIM ID** is enabled, the value will be the GS1-128 AIM ID, ]C1 (see [Symbology Charts](#) on page 277).

If **GS1 DataBar Emulation** is scanned, all retail codes (U.P.C., UPC-E, EAN8, EAN13) are expanded out to 16 digits. If the AIM ID is enabled, the value will be the GS1-DataBar AIM ID, ]em (see [Symbology Charts](#) on page 277).

If **GS1 Code Expansion Off** is scanned, retail code expansion is disabled, and UPC-E expansion is controlled by the [UPC-E0 Expand](#) (page 163) setting. If the AIM ID is enabled, the value will be the GS1-128 AIM ID, ]C1 (see [Symbology Charts](#) on page 277).

If **EAN8 to EAN13 Conversion** is scanned, all EAN8 barcodes are converted to EAN13 format.

*Default = GS1 Emulation Off.*



EANEMU1.  
GS1-128 Emulation



EANEMU2.  
GS1 DataBar Emulation



EANEMU3.  
GS1 Code Expansion Off



EANEMU4.  
EAN8 to EAN13 Conversion



EANEMU0.  
\* GS1 Emulation Off

## TCIF Linked Code 39 (TLC39)

This code is a composite code since it has a Code 39 linear component and a MicroPDF417 stacked code component. All barcode readers are capable of reading the Code 39 linear component. The MicroPDF417 component can only be decoded if TLC39 **On** is selected. The linear component may be decoded as Code 39 even if TLC39 is off. *Default = Off.*



T39ENA1.  
On



T39ENA0.  
\* Off



# QR Code

< Default All QR Code Settings >



## QR Code On/Off

This selection applies to both QR Code and Micro QR Code.



## QR Code Message Length

Scan the barcodes below to change the message length. Refer to [Message Length Description](#) (page 140) for additional information. Minimum and Maximum lengths = 1-7089. Minimum Default = 1, Maximum Default = 7089.



## QR Code Append

This function allows the scanner to append the data from several QR Code barcodes together before transmitting them to the host computer. When the scanner encounters a QR Code barcode with the append trigger character(s), it buffers the number of QR Code barcodes determined by information encoded in those barcodes. Once the proper number of codes is reached, the data is output in the order specified in the barcodes. There are 3 ways to scan appended QR Code:

**One Scan:** Pull the trigger one time and all appended QR Codes in the same image are decoded.

**Swipe:** Pull and hold down the trigger and scan all appended QR Codes while keeping the trigger pressed. The scanner emits short beeps for each partial QR Code that is scanned and buffered. One long beep is emitted after the last QR Code is scanned and the data is complete. Not compatible with Presentation mode.

**Point and Shoot:** Pull the trigger one time for each image. The scanner emits a short beep for each partial QR Code that is scanned and buffered. One long beep is emitted after the last QR Code is scanned and the data is complete. Not compatible with Presentation mode.

*Default = One Scan.*



QRCAPP1.

\* One Scan



QRCAPP2.

Swipe



QRCAPP3.

Point and Shoot



QRCAPP0.

Off

## QR Code Page

QR Code pages define the mapping of character codes to characters. If the data received does not display with the proper characters, it may be because the barcode being scanned was created using a code page that is different from the one the host program is expecting. If this is the case, scan the barcode below, select the code page with which the barcodes were created (see [ISO 2022/ISO 646 Character Replacements](#) on page 284), and scan the value and the **Save** barcode from the [Programming Chart](#), beginning on page 289. The data characters should then appear properly.



QRCDP.

QR Code Page

# QR Code with Web Link

Use this function to enable or disable the scanning of QR codes that contain “http” or “https”.



# DotCode

< Default All DotCode Settings >



# DotCode On/Off



# Poor Quality DotCodes

This setting improves the scanner’s ability to read damaged or badly printed Dot-Codes. *Default = Poor Quality DotCodes Off.*



## DotCode Message Length

Scan the barcodes below to change the message length. Refer to [Message Length Description](#) (page 140) for additional information. Minimum and Maximum lengths = 1-2400. Minimum Default = 1, Maximum Default = 2400.



DOTMIN.

**Minimum Message Length**



DOTMAX.

**Maximum Message Length**

## Digimarc Barcode™

### Digimarc Decoder Attempts

Set the number of attempts by scanning the barcode below, then setting the number of attempts (0-10) by scanning digits from the [Programming Chart](#) beginning on page 289 of this manual, the **Save**. *Minimum to Maximum attempts = 0-10. Default = 3.*



DIGSTR.

**Digimarc Decoder Attempts**

### Digimarc Barcode

This setting programs the scanner to decode Digimarc Barcode using Digimarc and ID decoders. When Digimarc Barcode is set to **On**, the Digimarc decoder is used on most frames and the ID decoder will read every fifth frame.

When Digimarc Barcode is set to **Uses ID Decoder then Both Decoders**, the ID decoder will read the number of attempts set by the Digimarc Decoder Attempts and then will use both ID and Digimarc decoders. When Digimarc Barcode is set to **Uses Digimarc Decoder then Both Decoders**, the Digimarc decoder will read the number of attempts set by the Digimarc Decoder Attempts and then will use both ID and Digimarc decoders.

When Digimarc Barcode is set to **Uses ID Decoder then Alternates Decoders**, the ID decoder will read the number of attempts set by the Digimarc Decoder Attempts and then will alternate between ID and Digimarc decoders. When Digimarc Barcode is set to **Uses Digimarc Decoder then Alternates Decoders**, the Digimarc decoder will read the number of attempts set by the Digimarc Decoder Attempts and then will alternate between ID and Digimarc decoders.

Default = DIGENA0: Off

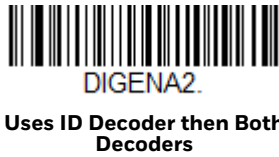

## Data Matrix

< Default All Data Matrix Settings >



## Data Matrix On/Off



# Direct Part Marking Decoding

If you are having trouble reading Direct Part Marking (DPM) barcodes, scan **Dotpeen DPM Decoding** for Dotpeen codes or scan **Reflective (Etched) DPM Decoding** for reflective (etched) codes. *Default = Disable DPM Decoding.*



# Data Matrix Message Length

Scan the barcodes below to change the message length. Refer to [Message Length Description](#) (page 140) for additional information. Minimum and Maximum lengths = 1-3116. Minimum Default = 1, Maximum Default = 3116.



# Data Matrix Code Page

Data Matrix Code pages define the mapping of character codes to characters. If the data received does not display with the proper characters, it may be because the barcode being scanned was created using a code page that is different from the one the host program is expecting. If this is the case, scan the barcode below, select the code page with which the barcodes were created (see [ISO 2022/ISO 646 Character Replacements](#) on page 284), and scan the value and the **Save** barcode from the [Programming Chart](#), beginning on page 289. The data characters should then appear properly.



# MaxiCode

< Default All MaxiCode Settings >



## MaxiCode On/Off



## MaxiCode Message Length

Scan the barcodes below to change the message length. Refer to [Message Length Description](#) (page 140) for additional information. Minimum and Maximum lengths = 1-150. Minimum Default = 1, Maximum Default = 150.



# Aztec Code

< Default All Aztec Code Settings >



## Aztec Code On/Off



## Aztec Code Message Length

Scan the barcodes below to change the message length. Refer to [Message Length Description](#) (page 140) for additional information. Minimum and Maximum lengths = 1-3832. Minimum Default = 1, Maximum Default = 3832.



## Aztec Append

This function allows the scanner to append the data from several Aztec barcodes together before transmitting them to the host computer. When the scanner encounters an Aztec barcode with the append trigger character(s), it buffers the number of Aztec barcodes determined by information encoded in those barcodes. Once the proper number of codes is reached, the data is output in the order specified in the barcodes. *Default = On.*





## Aztec Code Page

Aztec Code pages define the mapping of character codes to characters. If the data received does not display with the proper characters, it may be because the barcode being scanned was created using a code page that is different from the one the host program is expecting. If this is the case, scan the barcode below, select the code page with which the barcodes were created (see [ISO 2022/ISO 646 Character Replacements](#) on page 284), and scan the value and the **Save** barcode from the [Programming Chart](#), beginning on page 289. The data characters should then appear properly.



## Chinese Sensible (Han Xin) Code

< Default All Han Xin Settings >



## Han Xin Code On/Off

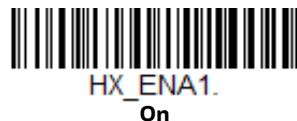

## Han Xin Code Message Length

Scan the barcodes below to change the message length. Refer to [Message Length Description](#) (page 140) for additional information. Minimum and Maximum lengths = 1-7833. Minimum Default = 1, Maximum Default = 7833.



# Postal Codes - 2D

The following lists the possible 2D postal codes, and 2D postal code combinations that are allowed. Only one 2D postal code selection can be active at a time. If you scan a second 2D postal code selection, the first selection is overwritten.

*Default = 2D Postal Codes Off.*



## Single 2D Postal Codes:



Also see [Planet Code Check Digit](#), page 197.





POSTAL6.

Postnet On

Also see [Postnet Check Digit](#), page 197.



POSTAL11.

Postnet with B and B' Fields On



POSTAL2.

InfoMail On

## Combination 2D Postal Codes:



POSTAL8.

InfoMail and British Post On



POSTAL20.

Intelligent Mail Barcode and Postnet with B and B' Fields On



POSTAL14.

Postnet and Postal-4i On



POSTAL16.

Postnet and Intelligent Mail Barcode On



POSTAL17.

Postal-4i and Intelligent Mail Barcode On



POSTAL19.

Postal-4i and Postnet with B and B' Fields On



**POSTAL12.**  
Planet Code and  
Postnet On



**POSTAL13.**  
Planet Code and  
Postal-4i On



**POSTAL21.**  
Planet Code,  
Postnet, and  
Postal-4i On



**POSTAL23.**  
Planet Code,  
Postal-4i, and  
Intelligent Mail Barcode On



**POSTAL25.**  
Planet Code,  
Postal-4i, and  
Postnet with B and B' Fields On



**POSTAL18.**  
Planet Code and  
Postnet with B and B' Fields On



**POSTAL15.**  
Planet Code and  
Intelligent Mail Barcode



**POSTAL22.**  
Planet Code,  
Postnet, and  
Intelligent Mail Barcode On



**POSTAL24.**  
Postnet,  
Postal-4i, and  
Intelligent Mail Barcode On



**POSTAL26.**  
Planet Code,  
Intelligent Mail Barcode, and  
Postnet with B and B' Fields On



**POSTAL27.**  
 Postal-4i,  
 Intelligent Mail Barcode, and  
 Postnet with B and B' Fields On



**POSTAL28.**  
 Planet Code,  
 Postal-4i,  
 Intelligent Mail Barcode, and  
 Postnet On



**POSTAL29.**  
 Planet Code,  
 Postal-4i,  
 Intelligent Mail Barcode, and  
 Postnet with B and B' Fields On

## Planet Code Check Digit

This selection allows you to specify whether the check digit should be transmitted at the end of Planet Code data. *Default = Don't Transmit.*



**PLNCKX1.**  
 Transmit Check Digit



**PLNCKX0.**  
 \* Don't Transmit Check Digit

## Postnet Check Digit

This selection allows you to specify whether the check digit should be transmitted at the end of Postnet data. *Default = Don't Transmit.*



**NETCKX1.**  
 Transmit Check Digit



**NETCKX0.**  
 \* Don't Transmit Check Digit

## Australian Post Interpretation

This option controls what interpretation is applied to customer fields in Australian 4-State symbols.

**Bar Output** lists the bar patterns in “0123” format.

**Numeric N Table** causes that field to be interpreted as numeric data using the N Table.

**Alphanumeric C Table** causes the field to be interpreted as alphanumeric data using the C Table. Refer to the Australian Post Specification Tables.

**Combination C and N Tables** causes the field to be interpreted using either the C or N Tables.



AUSINT0.  
\* Bar Output



AUSINT1.  
Numeric N Table



AUSINT2.  
Alphanumeric C Table



AUSINT3.  
Combination C and N Tables

## Postal Codes - Linear

The following lists linear postal codes. Any combination of linear postal code selections can be active at a time.

# China Post (Hong Kong 2 of 5)

<Default All China Post (Hong Kong 2 of 5) Settings>



## China Post (Hong Kong 2 of 5) On/Off



## China Post (Hong Kong 2 of 5) Message Length

Scan the barcodes below to change the message length. Refer to [Message Length Description](#) (page 140) for additional information. Minimum and Maximum lengths = 2-80. Minimum Default = 4, Maximum Default = 80.



# Korea Post

<Default All Korea Post Settings>



## Korea Post



## Korea Post Message Length

Scan the barcodes below to change the message length. Refer to [Message Length Description](#) (page 140) for additional information. Minimum and Maximum lengths = 2-80. Minimum Default = 4, Maximum Default = 48.



KPCMIN.

Minimum Message Length



KPCMAX.

Maximum Message Length

## Korea Post Check Digit

This selection allows you to specify whether the check digit should be transmitted or not. *Default = Don't Transmit.*



KPCCHK1.

Transmit Check Digit



KPCCHK0.

\* Don't Transmit Check Digit



The scanner is like a digital camera in the way it captures, manipulates, and transfers images. The following commands allow you to alter the way the scanner performs these functions.

## Single-Use Basis

Imaging Commands with their modifiers send instructions to the scanner on a single-use basis, and take effect for a single image capture. Once that capture is complete, the scanner reverts to its imaging default settings. If you want to permanently change a setting, you must use the serial default commands (see [Chapter 10](#)). When the serial default command is used, that selection becomes the new, permanent setting for the scanner.

## Command Syntax

Multiple modifiers and commands can be issued within one sequence. If additional modifiers are to be applied to the same command, just add the modifiers to that command. For example, to add 2 modifiers to the Image Snap command, such as setting the Imaging Style to 1P and the Wait for Trigger to 1T, you would enter **IMG SNP1P1T**.

**Note:** After processing an image capture command (*IMG SNP* or *IMG BOX*), you must follow it with an *IMG SHP* command if you want to see it on your terminal.

To add a command to a sequence, each new command is separated with a semicolon. For example, to add the Image Ship command to the above sequence, you would enter **IMG SNP1P1T;IMG SHP**.

The imaging commands are:

[Image Snap - IMG SNP](#) (page 202)

[Image Ship - IMG SHP](#) (page 205)

[Intelligent Signature Capture - IMG BOX](#) (page 214)

The modifiers for each of these commands follow the command description.

**Note:** *The images included with each command description are examples only. The results you achieve may be different from those included in this manual. The quality of the output you receive will vary depending on lighting, quality of the initial image/object being captured, and distance of the scanner from the image/object. To achieve a high quality image, it is recommended that you position your scanner 4-6" (10.2-15.2 cm) away from the image/object you are capturing.*

## Step 1 - Take a Picture Using IMGSNP

### Image Snap - IMGSNP

An image is taken whenever the hardware trigger is pressed, or when the Image Snap (IMGSNP) command is processed.

The image snap command has many different modifiers that can be used to change the look of the image in memory. Any number of modifiers may be appended to the IMGSNP command.

**Example:** You can use the following command to snap an image, increase the gain, and have the beeper sound once the snap is complete: **IMGSNP2G1B**

### IMGSNP Modifiers

#### P - Imaging Style

This sets the Image Snap style.

- 0P **Decoding Style.** This processing allows a few frames to be taken until the exposure parameters are met. The last frame is then available for further use.
- 1P **Photo Style (default).** This mimics a simple digital camera, and results in a visually optimized image.
- 2P **Manual Style.** This is an advanced style that should only be used by an experienced user. It allows you the most freedom to set up the scanner, and has no auto-exposure.

#### B - Beeper

Causes a beep to sound after an image is snapped.

- 0B No beep (default)
- 1B Sounds a beep when the image is captured.

## T - Wait for Trigger

Waits for a hardware trigger press before taking the image. This is only available when using Photo Style (1P).

- 0T Takes image immediately (*default*)
- 1T Waits for a trigger press, then takes the image

## L - LED State

Determines if the LEDs should be on or off, and when. Ambient illumination (0L) is preferred for taking pictures of color documents, such as ID cards, especially when the scanner is in a stand. LED illumination (1L) is preferred when the scanner is handheld. LED State is not available when using Decoding Style (0P).

- 0L LEDs off (*default*)
- 1L LEDs on

## E - Exposure

Exposure is used in Manual Style only (2P), and allows you to set the exposure time. This is similar to setting a shutter speed on a camera. The exposure time determines how long the scanner takes to record an image. On a bright day, exposure times can be very short because plenty of light is available to help record an image. At nighttime, exposure time can increase dramatically due to the near absence of light. Units are 127 microseconds. (*Default = 7874*)

- nE Range: 1 - 7874

### Example:

**Exposure at 7874E with fluorescent lighting:**

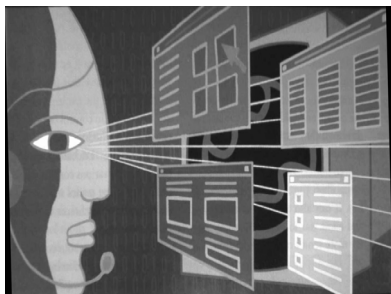

**Exposure at 100E with fluorescent lighting:**



## G - Gain

Gain is used in Manual Style only (2P). Like a volume control, the gain modifier boosts the signal and multiplies the pixel value. As you increase the gain, the noise in an image is also amplified.

1G No gain (*default*)

2G Medium gain

4G Heavy gain

8G Maximum gain

### Example:

Gain at 1G:



Gain at 4G:



Gain at 8G:



## W - Target White Value

Sets the target for the median grayscale value in the captured image. For capturing close-up images of high contrast documents, a lower setting, such as 75, is recommended. Higher settings result in longer exposure times and brighter images, but if the setting is too high, the image may be overexposed. Target White Value is only available when using Photo Style (1P). (*Default = 125*)

nW Range: 0 - 255

### Example:

White Value at 75W:



White Value at 125W:



White Value at 200W:



## D - Delta for Acceptance

This sets the allowable range for the white value setting ([see W - Target White Value](#)). Delta is only available when using Photo Style (1P). (*Default = 25*)

nD Range: 0 - 255

## U - Update Tries

This sets the maximum number of frames the scanner should take to reach the **D - Delta for Acceptance**. Update Tries is only available when using Photo Style (1P). (Default = 6)

nU Range: 0 - 10

## % - Target Set Point Percentage

Sets the target point for the light and dark values in the captured image. A setting of 75% means 75% of the pixels are at or below the target white value, and 25% of the pixels are above the target white value. Altering this setting from the default is not recommended under normal circumstances. To alter grayscale values, **W - Target White Value** should be used. (Default = 50)

n% Range: 1 - 99

### Example:

#### Target Set Point Percentage at 97%:

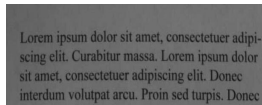

Lorem ipsum dolor sit amet, consectetur adipiscing elit. Curabitur massa. Lorem ipsum dolor sit amet, consectetur adipiscing elit. Donec interdum volutpat arcu. Proin sed turpis. Donec

#### Target Set Point Percentage at 50%:

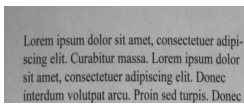

Lorem ipsum dolor sit amet, consectetur adipiscing elit. Curabitur massa. Lorem ipsum dolor sit amet, consectetur adipiscing elit. Donec interdum volutpat arcu. Proin sed turpis. Donec

#### Target Set Point Percentage at 40%:

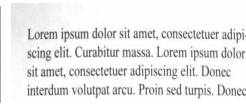

Lorem ipsum dolor sit amet, consectetur adipiscing elit. Curabitur massa. Lorem ipsum dolor sit amet, consectetur adipiscing elit. Donec interdum volutpat arcu. Proin sed turpis. Donec

## Step 2 - Ship a Picture Using IMGSHIP

### Image Ship - IMGSHIP

An image is taken whenever the trigger is pressed or when the Image Snap (IMGSNP) command is processed. The last image is always stored in memory. You can “ship” the image by using the IMGSHIP command.

The image ship commands have many different modifiers that can be used to change the look of the image output. Modifiers affect the image that is transmitted, but do not affect the image in memory. Any number of modifiers may be appended to the IMGSHIP command.

**Example:** You can use the following command to snap and ship a bitmap image with gamma correction and document image filtering: `IMGSNP;IMGSHIP8F75K26U`

# IMGSHHP Modifiers

## A - Infinity Filter

Enhances pictures taken from very long distances (greater than 10 feet or 3m). The Infinity Filter should not be used with [IMGSNP Modifiers](#) (page 202).

0A Infinity filter off (*default*)

1A Infinity filter on

**Example:**

**Infinity Filter off (0A)**  
from approximately 12 feet  
(3.66m) away:

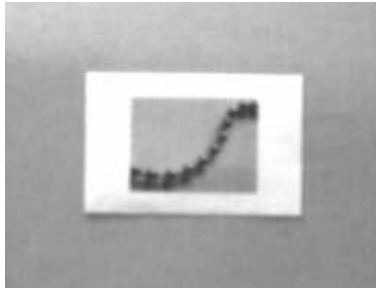

**Infinity Filter on (1A)**  
from approximately 12 feet (3.66m)  
away:

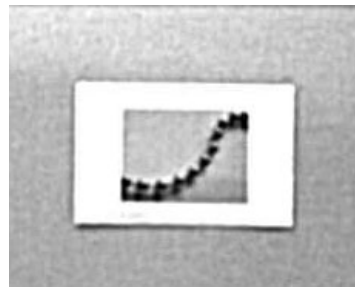

## C - Compensation

Flattens the image to account for variations in illumination across the image.

0C Compensation disabled (*default*)

1C Compensation enabled

**Example:**

**Compensation at 0C:**



**Compensation at 1C:**



## D - Pixel Depth

Indicates the number of bits per pixel in the transmitted image (KIM or BMP format only).

8D 8 bits per pixel, grayscale image (*default*)

1D 1 bit per pixel, black and white image

## E - Edge Sharpen

An edge sharpen filter cleans up the edges of an image, making it look cleaner and sharper. While edge sharpening does make the image look cleaner, it also removes some fine detail from the original image. The strength of the edge sharpen filter can be entered from 1 to 24. Entering a **23E** gives the sharpest edges, but also increases noise in the image.

- 0E Don't sharpen image (*default*)
- 14E Apply edge sharpen for typical image
- ne* Apply edge sharpen using strength *n* (*n* = 1-24)

### Example:

Edge Sharpen at 0E:



Edge Sharpen at 24E:



## F - File Format

Indicates the desired format for the image.

- 0F KIM format
- 1F TIFF binary
- 2F TIFF binary group 4, compressed
- 3F TIFF grayscale
- 4F Uncompressed binary (upper left to lower right, 1 pixel/bit, 0 padded end of line)
- 5F Uncompressed grayscale (upper left to lower right, bitmap format)
- 6F JPEG image (*default*)
- 8F BMP format (lower right to upper left, uncompressed)
- 15F BMP Uncompressed raw image

## H - Histogram Stretch

Increases the contrast of the transmitted image. Not available with some image formats.

0H No stretch (*default*)

1H Histogram stretch

**Example:**

**Histogram Stretch at 0H:**



**Histogram Stretch at 1H:**



## I - Invert Image

Invert image is used to rotate the image around the X or Y axis.

1ix Invert around the X axis (flips picture upside down)

1iy Invert around the Y axis (flips picture left to right)

**Example:**

**Image not inverted:**



**Image with Invert Image set to 1ix:**



**Image with Invert Image set to 1iy:**





## IF- Noise Reduction

Used to reduce the salt and pepper noise in an image.

0if No salt and pepper noise reduction (default)

1if Salt and pepper noise reduction

**Example:**

**Noise Reduction Off (0if):**



**Noise Reduction On (1if):**



## IR - Image Rotate

0ir Image as snapped (rightside up) (default)

1ir Rotate image 90 degrees to the right

2ir Rotate image 180 degrees (upside down)

3ir Rotate image 90 degrees to the left

**Example:**

**Image Rotate set to 0ir:**



**Image Rotate set to 2ir:**



**Image Rotate set to 1ir:**



**Image Rotate set to 3ir:**



## J - JPEG Image Quality

Sets the desired quality when the JPEG image format is selected. Higher numbers result in higher quality, but larger files. Smaller numbers result in greater amounts of lossy compression, faster transmission times, lower quality, but smaller files.

(Default = 50)

- $nJ$  Image is compressed as much as possible while preserving quality factor of  $n$  ( $n = 0 - 100$ )
- 0J worst quality (smallest file)
- 100J best quality (largest file)

## K - Gamma Correction

Gamma measures the brightness of midtone values produced by the image. You can brighten or darken an image using gamma correction. A higher gamma correction yields an overall brighter image. The lower the setting, the darker the image. The optimal setting for text images is 50K.

- 0K Gamma correction off (default)
- 50K Apply gamma correction for brightening typical document image
- $nK$  Apply gamma correction factor  $n$  ( $n = 0-1,000$ )

### Example:

Gamma Correction set to 0K:



Gamma Correction set to 50K:



Gamma Correction set to 255K:



## L, R, T, B, M - Image Cropping

Ships a window of the image by specifying the left, right, top, and bottom pixel coordinates. Device columns are numbered 0 through 1279, and device rows are numbered 0 through 959.

- $nL$  The left edge of the shipped image corresponds to column  $n$  of the image in memory. Range: 000 - 843. (Default = 0)
- $nR$  The right edge of the shipped image corresponds to column  $n - 1$  of the image in memory. Range: 000 - 843. (Default = all columns)
- $nT$  The top edge of the shipped image corresponds to row  $n$  of the image in memory. Range: 000 - 639. (Default = 0)

$nB$  The bottom edge of the shipped image corresponds to row  $n - 1$  of the image in memory. Range: 000 - 639. (Default = all rows)

**Example:**

**Uncropped Image:**



**Image Crop set to 300R:**



**Image Crop set to 300L:**

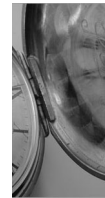

**Image Crop set to 200B:**



**Image Crop set to 200T:**



Alternately, specify the number of pixels to cut from the outside margin of the image; thus only the center pixels are transmitted.

$nM$  Margin: cut  $n$  columns from the left,  $n + 1$  columns from the right,  $n$  rows from the top, and  $n + 1$  rows from the bottom of the image. Ship the remaining center pixels. Range: 0 - 238. (Default = 0, or full image)

**Example:**

**Image Crop set to 238M:**



## P - Protocol

Used for shipping an image. Protocol covers two features of the image data being sent to the host. It addresses the protocol used to send the data (Hmodem, which is an Xmodem 1K variant that has additional header information), and the format of the image data that is sent.

- 0P None (raw data)
- 2P None (default for USB)
- 3P Hmodem compressed (default for RS232)
- 4P Hmodem

## S - Pixel Ship

Pixel Ship sizes an image in proportion to its original size. It decimates the image by shipping only certain, regularly spaced pixels.

**Example:** 4S would transmit every fourth pixel from every fourth line.

The smaller number of pixels shipped, the smaller the image, however, after a certain point the image becomes unusable.

- 1S ship every pixel (*default*)
- 2S ship every 2nd pixel, both horizontally and vertically
- 3S ship every 3rd pixel, both horizontally and vertically

**Example:**

**Pixel Ship set to 1S:**



**Pixel Ship set to 2S:**



**Pixel Ship set to 3S:**



**Pixel Ship set to 4S:**



## U - Document Image Filter

Allows you to input parameters to sharpen the edges and smooth the area between the edges of text in an image. This filter should be used with gamma correction (see [page 210](#)), with the scanner in a stand, and the image captured using the command:

**IMGSP1POL168W90%32D**

This filter typically provides better JPEG compression than the standard E - Edge Sharpen command (see [page 213](#)). This filter also works well when shipping pure black and white images (1 bit per pixel). The optimal setting is 26U.

- 0U Document image filter off (*default*)
- 26U Apply document image filter for typical document image
- nU Apply document image filter using grayscale threshold n. Use lower numbers when the image contrast is lower. 1U will have a similar effect to setting [E - Edge Sharpen](#) (page 207) to 22e. Range: 0-255.

**Example:**

**Document Image Filter set to 0U:**



**Document Image Filter set to 26U:**

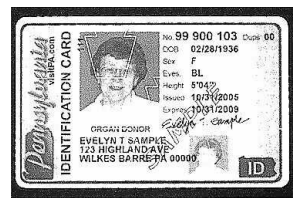

## V - Blur Image

Smooths transitions by averaging the pixels next to the hard edges of defined lines and shaded areas in an image.

0V Don't blur (*default*)

1V Blur

**Example:**

**Blur Image Off (0V):**



**Blur Image On (1V):**



## W - Histogram Ship

A histogram gives a quick picture of the tonal range of an image, or key type. A low-key image has detail concentrated in the shadows; a high-key image has detail concentrated in the highlights; and an average-key image has detail concentrated in the midtones. This modifier ships the histogram for an image.

0W Don't ship histogram (*default*)

1W Ship histogram

**Example:**

**Image used for histogram:**

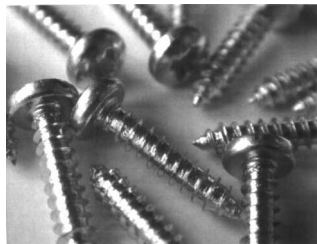

**Histogram of image:**



## Image Size Compatibility

If you have applications that expect an image ship to return exactly 640x480 pixels, scan the Force VGA Resolution barcode. *Default = Native Resolution.*



IMGVGA1.

Force VGA Resolution



## Intelligent Signature Capture - IMGBOX

IMGBOX allows you to configure the size and location of a signature capture area relative to its proximity to a barcode. This allows you to tailor a signature capture area to a specific form. In order to use IMGBOX, you need a set form where the signature box location is in a known location relative to a barcode. You can input the overall size of the signature area, as well as specify how far the signature area is from the barcode, vertically and horizontally. You can also set the resolution and file format for the final output of the signature capture image.

**Note:** *IMGBOX commands can only be triggered by one of the following types of barcodes: PDF417, Code 39, Code 128, Aztec, Codabar, and Interleaved 2 of 5. Once one of these symbologies has been read, the image is retained for a possible IMGBOX command.*

## Signature Capture Optimize

If you will be using your scanner to capture signatures frequently, you should optimize it for this purpose. However, the speed of scanning barcodes may be slowed when this mode is enabled. *Default = Off.*



Below is an example of a signature capture application. In this example, the aimer is centered over the signature capture area and the trigger is pressed. A single beep is emitted, indicating that the scanner has read a Code 128 barcode and the data has been transferred to the host. An IMGBOX command may now be sent from the host to specify the coordinates of the signature capture area below that code, and indicating that only that area containing the signature should be transferred as an image to the host.

To see this example, align the aimer with the signature area (not with the barcode), then press the trigger.



Send the following IMGBOX command string after the trigger press:

**Example:** IMGBOX245w37h55y.

**Note:** Case is not important in the command string. It is used here only for clarity.

The following image is captured:



The IMGBOX commands have many different modifiers that can be used to change the size and appearance of the signature image output by the scanner. Modifiers affect the image that is transmitted, but do not affect the image in memory. Any number of modifiers may be appended to the IMGBOX command.

**Note:** The IMGBOX command will return a NAK unless a window size (width and height) are specified. See [H - Height of Signature Capture Area](#) (page 217) and [W - Width of Signature Capture Area](#) (page 218).

## IMGBOX Modifiers

### A - Output Image Width

This option is used to size the image horizontally. If using this option, set the resolution (R) to zero.

**Example:** Image Width set to 200A:

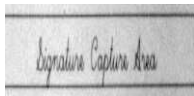
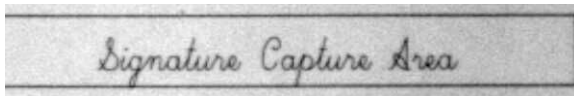

Image Width set to 600A:



## B - Output Image Height

This option is used to size the image vertically. If using this option, set the resolution (R) to zero.

### Example:

**Image Height set to 50B:**

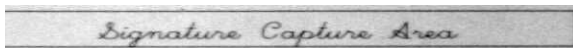

**Image Height set to 100B:**

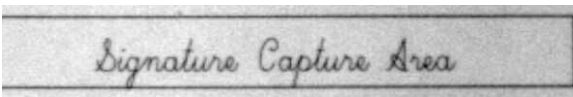

## D - Pixel Depth

This indicates the number of bits per pixel in the transmitted image, which defines whether it will be grayscale or black and white.

- 8D 8 bits per pixel, grayscale image (*default*)
- 1D 1 bit per pixel, black and white image

## F - File Format

This option indicates the type of file format in which to save the image.

- 0F KIM format
- 1F TIFF binary
- 2F TIFF binary group 4, compressed
- 3F TIFF grayscale
- 4F Uncompressed Binary
- 5F Uncompressed grayscale
- 6F JPEG image (*default*)
- 7F Outlined image
- 8F BMP format



## H - Height of Signature Capture Area

The height of the signature capture area must be measured in inches divided by .01. In the example, the height of the area to be captured is 3/8 inch, resulting in a value of  $H = .375/0.01 = 37.5$ .

Example: **IMGBOX245w37h55y**.

## K - Gamma Correction

Gamma measures the brightness of midtone values produced by the image. You can brighten or darken an image using gamma correction. A higher gamma correction yields an overall brighter image. The lower the setting, the darker the image. The optimal setting for text images is 50K.

0K    Gamma correction off (*default*)

50K    Apply gamma correction for brightening typical document image

nK    Apply gamma correction factor  $n$  ( $n = 1-255$ )

### Example:

**Gamma Correction set to 0K:**



**Gamma Correction set to 50K:**



**Gamma Correction set to 255K:**

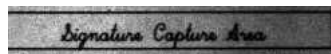

## R - Resolution of Signature Capture Area

The resolution is the number of pixels that the scanner outputs per each minimum bar width. The higher the value for R, the higher the quality of the image, but also the larger the file size. Values begin at 1000. The scanner automatically inserts a

decimal point between the first and second digit. For example, use 2500 to specify a resolution of 2.5. Set to zero when using the A and B modifiers (see [A - Output Image Width](#) and [B - Output Image Height](#) on page 216).

**Example:** Resolution set to 0R:

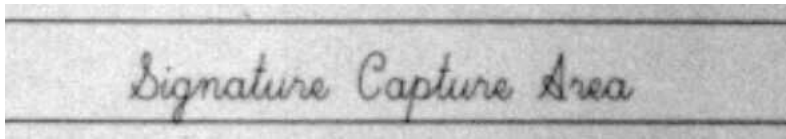

Resolution set to 100R:



Resolution set to 200R:

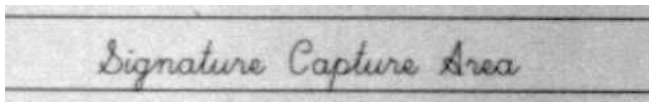

## S - Barcode Aspect Ratio

All dimensions used in IMGBOX are measured as multiples of the minimum element size of the barcode. The barcode aspect ratio allows you to set the ratio of the barcode height to the narrow element width. In the example, the narrow element width is .010 inches and the barcode height is 0.400 inches, resulting in a value of  $S = 0.4/0.01 = 40$ .

## W - Width of Signature Capture Area

The width of the signature capture area must be measured in inches divided by .01. In the example, the width of the area to be captured is 2.4 inches, resulting in a value of  $W = 2.4/0.01 = 240$ . (A value of 245 was used in the example to accommodate a slightly wider image area.)

Example: *IMGBOX245w37h55y*.

## X - Horizontal Barcode Offset

The horizontal barcode offset allows you to offset the horizontal center of the signature capture area. Positive values move the horizontal center to the right and negative values to the left. Measurements are in multiples of the minimum bar width.

**Example:**

Horizontal Offset set to 75X:

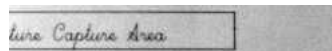

Horizontal Offset set to -75X:

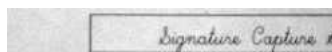

## Y - Vertical Barcode Offset

The vertical barcode offset allows you to offset the vertical center of the signature capture area. Negative numbers indicate that the signature capture is above the barcode, and positive numbers indicate that the area is below the barcode. Measurements are in multiples of the minimum bar width

**Example:**

**Vertical Offset set to -7Y:**



**Vertical Offset set to 65Y:**

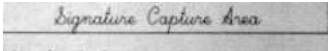

## RF Default Imaging Device

The scanner supports imaging command processing (IMGSHIP, IMGSNP, IMGBOX) so that EZConfig for Scanning (see page 223) and other applications are able to perform imaging functions as if they were communicating directly with a scanner. To accomplish this, the scanner uses a menu command called RF\_DID (RF Default Imaging Device). RF\_DID is the name of the scanner (BT\_NAM) that is to receive imaging commands. The default for RF\_DID is "\*" indicating that imaging commands are to be sent to all associated scanners. Change this setting to RF\_DID-*scanner\_name* to ensure that they are sent to a particular scanner. Refer to "Page" on page 3-50 to generate a report containing the port, work group, scanner name, and address for each scanner. Refer to "Scanner Name" on page 3-64 set a unique name for each scanner.



## To Add a Test Code I.D. Prefix to All Symbologies

This selection allows you to turn on transmission of a Code I.D. before the decoded symbology. (See the [Symbology Charts](#), beginning on page 277 for the single character code that identifies each symbology.) This action first clears all current prefixes, then programs a Code I.D. prefix for all symbologies. This is a temporary setting that will be removed when the unit is power cycled.



PRECA2,BK2995C80!

Add Code I.D. Prefix to  
All Symbologies (Temporary)

## Show Software Revision

Scan the barcode below to output the current software revision, unit serial number, and other product information for both the scanner and base.



REVINF.

Show Software Revision

## Test Menu

When you scan the **Test Menu On** code, then scan a programming code in this manual, the scanner displays the content of a programming code. The programming function will still occur, but in addition, the content of that programming code is output to the terminal.

**Note:** This feature should not be used during normal scanner operation.



## TotalFreedom

TotalFreedom is an open system architecture that makes it possible for you create applications that reside on your scanner. Decoding apps and Data Formatting apps can be created using TotalFreedom. For further information about TotalFreedom, go to our website at [www.honeywellaidc.com](http://www.honeywellaidc.com).

## Application Plug-Ins (Apps)

Any apps that you are using can be turned off or on by scanning the following barcodes. Apps are stored in groups: Decoding, and Formatting. You can enable and disable these groups of apps by scanning that group's On or Off barcode below. You can also scan the List Apps barcode to output a list of all your apps.



**Note:** You must reset your device in order for the apps setting to take effect.

# EZConfig for Scanning Introduction

EZConfig for Scanning provides a wide range of PC-based programming functions that can be performed on the scanner connected to your PC. EZConfig for Scanning allows you to download upgrades to the scanner's firmware, change programmed parameters, and create and print programming barcodes. Using EZConfig for Scanning, you can even save/open the programming parameters. This saved file can be e-mailed or, if required, you can create a single barcode that contains all the customized programming parameters and mail or fax that barcode to any location. Users in other locations can scan the barcode to load in the customized programming.

## Configure with EZConfig for Scanning

Use the EZConfig for Scanning tool to configure your scanner online:

1. Access the Honeywell Technical Support Downloads Portal at <https://hsmftp.honeywell.com>.
2. Go to **Software > Barcode Scanners > Software > Tools and Utilities > EZConfig for Scanning > Current**.

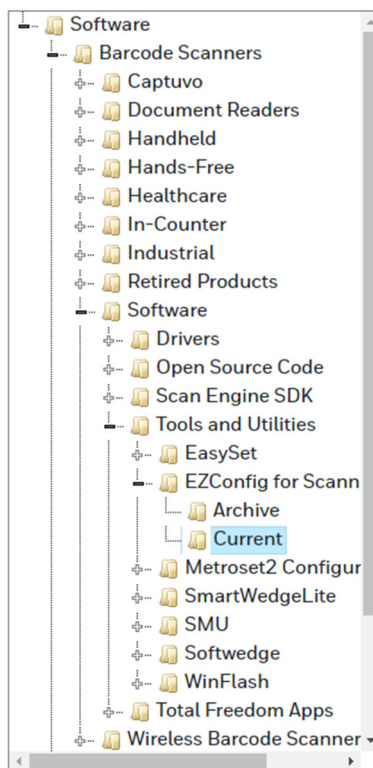

3. Download the **Setup** version of EZConfig for Scanning.
4. Open EZConfig to configure your scanner.

# Reset the Factory Defaults



**Caution:** *This selection erases all your settings and resets the scanner to the original factory defaults. It also disables all plugins.*

If you aren't sure what programming options are in your scanner, or you've changed some options and want to restore the scanner to factory default settings, first scan the **Remove Custom Defaults** barcode, then scan **Activate Defaults**. This resets the scanner to the factory default settings.



DEFOVR.

**Remove Custom Defaults**



DEFAULT.

**Activate Defaults**

**Note:** *If using a cordless system, scanning the **Activate Defaults** barcode also causes both the scanner and the base or Access Point to perform a reset and become unlinked. The scanner must be placed in its base to re-establish the link before any setup codes are entered. If using an Access Point, the linking barcode must be scanned. See [Cordless System Operation](#) beginning on page 39 for additional information.*

The [Menu Commands](#), beginning on page 230, list the factory default settings for each of the commands (indicated by an asterisk (\*) on the programming pages).



# SERIAL PROGRAMMING COMMANDS

The serial programming commands can be used in place of the programming barcodes. Both the serial commands and the programming barcodes will program the scanner. For complete descriptions and examples of each serial programming command, refer to the corresponding programming barcode in this manual.

The device must be set to an RS232 interface (see [page 14](#)). The following commands can be sent via a PC COM port using terminal emulation software.

## Conventions

The following conventions are used for menu and query command descriptions:

<i>parameter</i>	A label representing the actual value you should send as part of a command.
[ <i>option</i> ]	An optional part of a command.
{Data}	Alternatives in a command.
<b>bold</b>	Names of menus, menu commands, buttons, dialog boxes, and windows that appear on the screen.

## Menu Command Syntax

Menu commands have the following syntax (spaces have been used for clarity only):

*Prefix* [*:Name:*] *Tag SubTag {Data}* [, *SubTag {Data}*] [*; Tag SubTag {Data}*] [...] *Storage*

**Prefix** Three ASCII characters: SYN M CR (ASCII 22,77,13).

**:Name:** This command is only used with cordless devices. It is used to specify whether you're communicating with the base or the scanner. To send information to the scanner (with the base connected to host), use **:Granit:** The default factory setting for a Granit XP scanner is Granit

scanner. This setting is changed by using the BT\_NAM command, which accepts alphanumeric values. If the name is not known, a wildcard (\*) can be used :\*

**Note:** *Since the base stores all work group settings and transfers to them to scanner once they are linked, changes are typically done to the base and not to the scanner.*

Tag	A 3 character case-insensitive field that identifies the desired menu command group. For example, all RS232 configuration settings are identified with a Tag of <b>232</b> .
SubTag	A 3 character case-insensitive field that identifies the desired menu command within the tag group. For example, the SubTag for the RS232 baud rate is <b>BAD</b> .
Data	The new value for a menu setting, identified by the Tag and SubTag.
Storage	A single character that specifies the storage table to which the command is applied. An exclamation point (!) performs the command's operation on the device's volatile menu configuration table. A period (.) performs the command's operation on the device's non-volatile menu configuration table. Use the non-volatile table only for semi-permanent changes you want saved through a power cycle.

## Query Commands

Several special characters can be used to query the device about its settings.

- ^ What is the default value for the setting(s).
- > What is the PAP sub command.

**Note:** *When using the >, all other commands will return NAK.*

- ? What is the device's current value for the setting(s).
- \* What is the range of possible values for the setting(s). (The device's response uses a dash (-) to indicate a continuous range of values. A pipe (|) separates items in a list of non-continuous values.)

### :Name: Field Usage (Optional)

This command returns the query information from the scanner.

### Tag Field Usage

When a query is used in place of a Tag field, the query applies to the *entire* set of commands available for the particular storage table indicated by the Storage field of the command. In this case, the SubTag and Data fields should not be used because they are ignored by the device.

## SubTag Field Usage

When a query is used in place of a SubTag field, the query applies only to the subset of commands available that match the Tag field. In this case, the Data field should not be used because it is ignored by the device.

## Data Field Usage

When a query is used in place of the Data field, the query applies only to the specific command identified by the Tag and SubTag fields.

## Concatenation of Multiple Commands

Multiple commands can be issued within one Prefix/Storage sequence. Only the Tag, SubTag, and Data fields must be repeated for each command in the sequence. If additional commands are to be applied to the same Tag, then the new command sequence is separated with a comma (,) and only the SubTag and Data fields of the additional command are issued. If the additional command requires a different Tag field, the command is separated from previous commands by a semicolon (;).

## Responses

The device responds to serial commands with one of three responses:

- ACK <06>** Indicates a good command which has been processed.
- ENQ <15>** Indicates an invalid Tag or SubTag command.
- NAK <05>** Indicates the command was good, but the Data field entry was out of the allowable range for this Tag and SubTag combination, e.g., an entry for a minimum message length of 100 when the field will only accept 2 characters.

When responding, the device echoes back the command sequence with the status character inserted directly before each of the punctuation marks (the period, exclamation point, comma, or semicolon) in the command.

## Examples of Query Commands

In the following examples, a bracketed notation [ ] depicts a non-displayable response.

**Example:** What is the range of possible values for Codabar Coding Enable?

**Enter:**           **cbrena\*.**

**Response:**   **CBRENA0-1[ACK]**

This response indicates that Codabar Coding Enable (CBRENA) has a range of values from 0 to 1 (off and on).

**Example:** What is the default value for Codabar Coding Enable?

**Enter:**        **cbrena^.**

**Response:**   **CBRENA1[ACK]**

This response indicates that the default setting for Codabar Coding Enable (CBRENA) is 1, or on.

**Example:** What is the device's current setting for Codabar Coding Enable?

**Enter:**        **cbrena?.**

**Response:**   **CBRENA1[ACK]**

This response indicates that the device's Codabar Coding Enable (CBRENA) is set to 1, or on.

**Example:** What are the device's settings for all Codabar selections?

**Enter:**        **cbr?.**

**Response:**   **CBRENA1[ACK],  
SSX0[ACK],  
CK20[ACK],  
CCT1[ACK],  
MIN2[ACK],  
MAX60[ACK],  
DFT[ACK].**

This response indicates that the device's Codabar Coding Enable (CBRENA) is set to 1, or on;  
the Start/Stop Character (SSX) is set to 0, or Don't Transmit;  
the Check Character (CK2) is set to 0, or Not Required;  
concatenation (CCT) is set to 1, or Enabled;  
the Minimum Message Length (MIN) is set to 2 characters;  
the Maximum Message Length (MAX) is set to 60 characters;  
and the Default setting (DFT) has no value.

## Trigger Commands

You can activate and deactivate the scanner with serial trigger commands. First, the scanner must be put in Manual Trigger Mode by scanning a Manual Trigger Mode barcode ([page 83](#)), or by sending a serial menu command for triggering ([page 85](#)). Once the scanner is in serial trigger mode, the trigger is activated and deactivated by sending the following commands:

Activate:        **SYN T CR**

Deactivate:     **SYN U CR**

The scanner scans until a barcode has been read, until the deactivate command is sent, or until the serial time-out has been reached (see [Read Time-Out](#) on page 85 for a description, and the serial command on [page 239](#)).

## Reset the Custom Defaults

If you want the custom default settings restored to your scanner, scan the **Activate Custom Defaults** barcode below. This resets the scanner to the custom default settings. If there are no custom defaults, it will reset the scanner to the factory default settings. Any settings that have not been specified through the custom defaults will be defaulted to the factory default settings.



DEFAULT.

**Activate Custom Defaults**

**Note:** *If using a cordless system, scanning this barcode also causes both the scanner and the base or Access Point to perform a reset and become unlinked. The scanner must be placed in its base to re-establish the link. If using an Access Point, the linking barcode must be scanned. See [Cordless System Operation](#) beginning on page 39 for additional information.*

The charts on the following pages list the factory default settings for each of the commands (indicated by an asterisk (\*) on the programming pages).

# Menu Commands

Selection	Setting * Indicates default	Serial Command # Indicates a numeric entry	Page
<b>Product Default Settings</b>			
Set Custom Defaults	Set Custom Defaults	MNUCDP	11
	Save Custom Defaults	MNUCDS	11
Reset the Custom Defaults	Activate Custom Defaults	DEFAULT	11
Reset the Factory Defaults - cordless scanners	Factory Default Settings: All Application Groups	PAPDFT&	66
Reset the Custom Defaults - cordless scanners	Custom Default Settings: All Application Groups	PAPDFT	67
<b>Program the Interface</b>			
Plug and Play Codes	Keyboard Wedge: IBM PC AT and Compatibles with CR suffix	PAP_AT	13
	Laptop Direct Connect with CR suffix	PAPLTD	14
	RS232 Serial Port	PAP232	14
Plug and Play Codes: RS485	IBM Port 5B Interface	PAPP5B	14
	IBM Port 9B HHBCR-1 Interface	PAP9B1	14
	IBM Port 17 Interface	PAPP17	15
	IBM Port 9B HHBCR-2 Interface	PAP9B2	15
Plug and Play Codes: IBM SurePos	USB IBM SurePos Handheld	PAPSPH	15
	USB IBM SurePos Tabletop	PAPSPT	15
Plug and Play Codes: USB	USB Keyboard (PC)	PAP124	16
	USB Keyboard (Mac)	PAP125	16
	USB Japanese Keyboard (PC)	TRMUSB134	16
	USB HID	PAP131	16
	USB Serial	TRMUSB130	16
	CTS/RTS Emulation On	USBCTS1	17
	*CTS/RTS Emulation Off	USBCTS0	17
	ACK/NAK Mode On	USBACK1	17
	*ACK/NAK Mode Off	USBACK0	17
	*Report PID as built	USBXnn0	17
	Report PID as Granit 1910i	USBXnn3	17
	Report PID as Granit 1980i	USBXnn4	17
Plug and Play Codes	Verifone Ruby Terminal	PAPRBY	18
	Gilbarco Terminal	PAPGLB	18
	Honeywell Bioptic Aux Port	PAPBIO	18
	Datalogic Magellan Aux Port	PAPMAG	19

<b>Selection</b>	<b>Setting * Indicates default</b>	<b>Serial Command # Indicates a numeric entry</b>	<b>Page</b>
	Wincor Nixdorf Terminal	PAPWNX	<a href="#">19</a>
	Wincor Nixdorf Beetle	PAPBTL	<a href="#">19</a>
	Wincor Nixdorf RS232 Mode A	PAPWMA	<a href="#">20</a>
Program Keyboard Country	*U.S.A.	KBDCTY0	<a href="#">20</a>
	Albania	KBDCTY35	<a href="#">20</a>
	Azeri (Cyrillic)	KBDCTY81	<a href="#">20</a>
	Azeri (Latin)	KBDCTY80	<a href="#">20</a>
	Belarus	KBDCTY82	<a href="#">21</a>
	Belgium	KBDCTY1	<a href="#">21</a>
	Bosnia	KBDCTY33	<a href="#">21</a>
	Brazil	KBDCTY16	<a href="#">21</a>
	Brazil (MS)	KBDCTY59	<a href="#">21</a>
	Bulgaria (Cyrillic)	KBDCTY52	<a href="#">21</a>
	Bulgaria (Latin)	KBDCTY53	<a href="#">21</a>
	Canada (French legacy)	KBDCTY54	<a href="#">21</a>
	Canada (French)	KBDCTY18	<a href="#">21</a>
	Canada (Multilingual)	KBDCTY55	<a href="#">21</a>
	Croatia	KBDCTY32	<a href="#">21</a>
	Czech	KBDCTY15	<a href="#">21</a>
	Czech (Programmers)	KBDCTY40	<a href="#">22</a>
	Czech (QWERTY)	KBDCTY39	<a href="#">22</a>
	Czech (QWERTZ)	KBDCTY38	<a href="#">22</a>
	Denmark	KBDCTY8	<a href="#">22</a>
	Dutch (Netherlands)	KBDCTY11	<a href="#">22</a>
	Estonia	KBDCTY41	<a href="#">22</a>
	Faroese	KBDCTY83	<a href="#">22</a>
	Finland	KBDCTY2	<a href="#">22</a>
	France	KBDCTY3	<a href="#">22</a>
	Gaelic	KBDCTY84	<a href="#">22</a>
	Germany	KBDCTY4	<a href="#">22</a>
	Greek	KBDCTY17	<a href="#">22</a>
	Greek (220 Latin)	KBDCTY64	<a href="#">23</a>
	Greek (220)	KBDCTY61	<a href="#">23</a>
	Greek (319 Latin)	KBDCTY65	<a href="#">23</a>
	Greek (319)	KBDCTY62	<a href="#">23</a>
	Greek (Latin)	KBDCTY63	<a href="#">23</a>
Greek (MS)	KBDCTY66	<a href="#">23</a>	

Selection	Setting * Indicates default	Serial Command # Indicates a numeric entry	Page
	Greek (Polytonic)	KBDCTY60	<a href="#">23</a>
	Hebrew	KBDCTY12	<a href="#">23</a>
	Hungarian (101 key)	KBDCTY50	<a href="#">23</a>
	Hungary	KBDCTY19	<a href="#">23</a>
	Iceland	KBDCTY75	<a href="#">23</a>
	Irish	KBDCTY73	<a href="#">23</a>
	Italian (142)	KBDCTY56	<a href="#">24</a>
	Italy	KBDCTY5	<a href="#">24</a>
	Japan ASCII	KBDCTY28	<a href="#">24</a>
	Kazakh	KBDCTY78	<a href="#">24</a>
	Kyrgyz (Cyrillic)	KBDCTY79	<a href="#">24</a>
	Latin America	KBDCTY14	<a href="#">24</a>
	Latvia	KBDCTY42	<a href="#">24</a>
	Latvia (QWERTY)	KBDCTY43	<a href="#">24</a>
	Lithuania	KBDCTY44	<a href="#">24</a>
	Lithuania (IBM)	KBDCTY45	<a href="#">24</a>
	Macedonia	KBDCTY34	<a href="#">24</a>
	Malta	KBDCTY74	<a href="#">24</a>
	Mongolian (Cyrillic)	KBDCTY86	<a href="#">25</a>
	Norway	KBDCTY9	<a href="#">25</a>
	Poland	KBDCTY20	<a href="#">25</a>
	Polish (214)	KBDCTY57	<a href="#">25</a>
	Polish (Programmers)	KBDCTY58	<a href="#">25</a>
	Portugal	KBDCTY13	<a href="#">25</a>
	Romania	KBDCTY25	<a href="#">25</a>
	Russia	KBDCTY26	<a href="#">25</a>
	Russian (MS)	KBDCTY67	<a href="#">25</a>
	Russian (Typewriter)	KBDCTY68	<a href="#">25</a>
	SCS	KBDCTY21	<a href="#">25</a>
	Serbia (Cyrillic)	KBDCTY37	<a href="#">25</a>
	Serbia (Latin)	KBDCTY36	<a href="#">26</a>
	Slovakia	KBDCTY22	<a href="#">26</a>
	Slovakia (QWERTY)	KBDCTY49	<a href="#">26</a>
	Slovakia (QWERTZ)	KBDCTY48	<a href="#">26</a>
	Slovenia	KBDCTY31	<a href="#">26</a>
	Spain	KBDCTY10	<a href="#">26</a>
	Spanish variation	KBDCTY51	<a href="#">26</a>



<b>Selection</b>	<b>Setting * Indicates default</b>	<b>Serial Command # Indicates a numeric entry</b>	<b>Page</b>
	Sweden	KBDCTY23	<a href="#">26</a>
	Switzerland (French)	KBDCTY29	<a href="#">26</a>
	Switzerland (German)	KBDCTY6	<a href="#">26</a>
	Tatar	KBDCTY85	<a href="#">26</a>
	Turkey F	KBDCTY27	<a href="#">26</a>
	Turkey Q	KBDCTY24	<a href="#">27</a>
	Ukrainian	KBDCTY76	<a href="#">27</a>
	United Kingdom	KBDCTY7	<a href="#">27</a>
	United States (Dvorak right)	KBDCTY89	<a href="#">27</a>
	United States (Dvorak left)	KBDCTY88	<a href="#">27</a>
	United States (Dvorak)	KBDCTY87	<a href="#">27</a>
	United States (International)	KBDCTY30	<a href="#">27</a>
	Uzbek (Cyrillic)	KBDCTY77	<a href="#">27</a>
ALT Mode	* Off	KBDALT0	<a href="#">28</a>
	3 Characters	KBDALT6	<a href="#">28</a>
	4 Characters	KBDALT7	<a href="#">28</a>
Keyboard Style	*Regular	KBDSTY0	<a href="#">28</a>
	Caps Lock	KBDSTY1	<a href="#">28</a>
	Shift Lock	KBDSTY2	<a href="#">28</a>
	Caps Lock Shift Enable (Europe)	KBDCSE0	<a href="#">28</a>
	Caps Lock Shift Enable (China)	KBDCSE1	<a href="#">28</a>
	Automatic Caps Lock	KBDSTY6	<a href="#">29</a>
	Autocaps via Num Lock	KBDSTY7	<a href="#">29</a>
	Emulate External Keyboard	KBDSTY5	<a href="#">29</a>
Keyboard Conversion	*Keyboard Conversion Off	KBDCNV0	<a href="#">30</a>
	Convert all Characters to Upper Case	KBDCNV1	<a href="#">30</a>
	Convert all Characters to Lower Case	KBDCNV2	<a href="#">30</a>
Control Character Output	*Control Character Output Off	KBDNPE0	<a href="#">30</a>
	Control Character Output On	KBDNPE1	<a href="#">30</a>

<b>Selection</b>	<b>Setting * Indicates default</b>	<b>Serial Command # Indicates a numeric entry</b>	<b>Page</b>
Keyboard Modifiers	*Control + X Off	KBDCAS0	<a href="#">31</a>
	DOS Mode Control + X	KBDCAS1	<a href="#">31</a>
	Windows Mode Control + X	KBDCAS2	<a href="#">31</a>
	Windows Mode Prefix/Suffix Off	KBDCAS3	<a href="#">31</a>
	DOS Mode Control + X Mode On with Windows Mode Prefix/Suffix	KBDCAS4	<a href="#">31</a>
	Supports ALT 3 Digit HEX Mode	KBDCAS5	<a href="#">31</a>
	*Turbo Mode Off	KBDTMD0	<a href="#">31</a>
	Turbo Mode On	KBDTMD1	<a href="#">31</a>
	*Numeric Keypad Off	KBDNPS0	<a href="#">32</a>
	Numeric Keypad On	KBDNPS1	<a href="#">32</a>
	*Auto Direct Connect Off	KBDADC0	<a href="#">32</a>
	Auto Direct Connect On	KBDADC1	<a href="#">32</a>
Baud Rate	300 BPS	232BAD0	<a href="#">32</a>
	600 BPS	232BAD1	<a href="#">32</a>
	1200 BPS	232BAD2	<a href="#">32</a>
	2400 BPS	232BAD3	<a href="#">33</a>
	4800 BPS	232BAD4	<a href="#">33</a>
	9600 BPS	232BAD5	<a href="#">33</a>
	19200 BPS	232BAD6	<a href="#">33</a>
	38400 BPS	232BAD7	<a href="#">33</a>
	57600 BPS	232BAD8	<a href="#">33</a>
	*115200 BPS	232BAD9	<a href="#">33</a>
Word Length: Data Bits, Stop Bits, and Parity	7 Data, 1 Stop, Parity Even	232WRD3	<a href="#">33</a>
	7 Data, 1 Stop, Parity None	232WRD0	<a href="#">33</a>
	7 Data, 1 Stop, Parity Odd	232WRD6	<a href="#">34</a>
	7 Data, 2 Stop, Parity Even	232WRD4	<a href="#">34</a>
	7 Data, 2 Stop, Parity None	232WRD1	<a href="#">34</a>
	7 Data, 2 Stop, Parity Odd	232WRD7	<a href="#">34</a>
	8 Data, 1 Stop, Parity Even	232WRD5	<a href="#">34</a>
	*8 Data, 1 Stop, Parity None	232WRD2	<a href="#">34</a>
	8 Data, 1 Stop, Parity Odd	232WRD8	<a href="#">34</a>
	8 Data, 1 Stop, Parity Mark	232WRD14	<a href="#">34</a>
RS232 Receiver Time-out	Range 0 - 300 seconds *0	232LPT###	<a href="#">34</a>

<b>Selection</b>	<b>Setting * Indicates default</b>	<b>Serial Command # Indicates a numeric entry</b>	<b>Page</b>
RS232 Handshaking	*RTS/CTS Off	232CTS0	35
	Flow Control, No Timeout	232CTS1	35
	Two-Direction Flow Control	232CTS2	35
	Flow Control with Timeout	232CTS3	35
	RS232 Timeout (1-5100 milliseconds)	232DEL####	35
	*XON/XOFF Off	232XON0	36
	XON/XOFF On	232XON1	36
	*ACK/NAK Off	232ACK0	36
	ACK/NAK On	232ACK1	36
Scanner-Bioptic Packet Mode	*Packet Mode Off	232PKT0	37
	Packet Mode On	232PKT2	37
Scanner-Bioptic ACK/NAK Mode	*Bioptic ACK/NAK Off	232NAK0	37
	Bioptic ACK/NAK On	232NAK1	37
Scanner-Bioptic ACK/NAK Timeout	ACK/NAK Timeout (1-30000 milliseconds) *5100	232DLK#####	37
<b>Cordless System Operation</b>			
Link the Scanner to the charge base	Legacy Mode	LKBMOD0	39
	Compatibility Mode	LKBMOD1	40
Replace a Linked Scanner	Override locked Scanner (Single Scanner)	BT_RPL1	40
Temporary Streaming Presentation Mode	*10 Second Timeout	TRGTPM10000	43
	30 Second Timeout	TRGTPM30000	43
Presentation Mode in Base	*Disabled	BT_PIB0	44
	Enabled	BT_PIB1	44
Connect with Bluetooth Device directly	Disabled	BT_CEN0	68
	Enabled	BT_CEN1	68
Base Power Communication Indicator	*On	.*:BASRED1	47
	Off	.*:BASREDO	47
Reset Scanner	Reset Scanner	RESET_	49
Base Charge Modes	Base Charge Off	BTRCHG0	49
	*External or Interface Cable Power	BTRCHG1	49
	External Power Only	BTRCHG2	49
Page Mode	*On	BEPPGE1	50
	Off	BEPPGE0	50
Page Pitch	*Low (1000 Hz)	BEPPFQ1000	50
	Medium (3250 Hz)	BEPPFQ3250	50
	High (4200 Hz)	BEPPFQ4200	50

<b>Selection</b>	<b>Setting * Indicates default</b>	<b>Serial Command # Indicates a numeric entry</b>	<b>Page</b>
Beeper Pitch - Base Error	*Low/Razz (250 Hz) (min 200 Hz)	BASFQ2250	51
	Medium (3250 Hz)	BASFQ23250	51
	High (4200 Hz) (max 9000 Hz)	BASFQ24200	51
Number of Beeps - Base Error	*1 (Range 1 - 9)	BASERR#	51
Scanner Report	Scanner Report	RPTSCN	51
Scanner Address	Scanner Address	BT_LDA	52
Base Address	Base Address	BASLDA	52
Scanner Modes	Charge Only Mode	BASLNK0	52
	*Charge and Link Mode	BASLNK1	53
	Locked Link Mode	BASCON0,DNG1	53
	*Open Link Mode	BASCON1,DNG1	53
	Unlink Scanner	BT_RMV	54
	Override Locked Scanner	BT_RPL1	54
Out-of-Range Alarm	Base Alarm Duration (Range 1 - 3000 sec) *0	BASORD####	54
	Scanner Alarm Duration (Range 1 - 3000 sec) *0	BT_ORD####	54
Alarm Sound Type	Base Alarm Type (0-7) *0	BASORW#	55
	Scanner Alarm Type (0-7) *0	BT_ORW#	55
Scanner Power Time-Out Timer	0 Seconds	BT_LPT0	56
	200 Seconds	BT_LPT200	56
	400 Seconds	BT_LPT400	56
	900 Seconds	BT_LPT900	56
	*3600 Seconds	BT_LPT3600	56
	7200 Seconds	BT_LPT7200	56
Flexible Power Management for Granit XP	*Full Power (100%)	BT_TXP100	57
	Medium Power (35%)	BT_TXP35	57
	Medium Low Power (5%)	BT_TXP5	57
	Low Power (1%)	BT_TXP1	57
Batch Mode	Automatic Batch Mode	BATENA1	58
	*Batch Mode Off	BATENA0	58
	Inventory Batch Mode	BATENA2	58
	Persistent Batch Mode	BATENA3	58
Batch Mode Beep	Off	BATBEP0	59
	*On	BATBEP1	59
Batch Mode Storage	*Flash Storage	BATNVS1	59
	RAM Storage	BATNVS0	59

<b>Selection</b>	<b>Setting * Indicates default</b>	<b>Serial Command # Indicates a numeric entry</b>	<b>Page</b>
Batch Mode Quantity	*Off	BATQTY0	60
	On	BATQTY1	60
Quantity Codes	0	BATNUM0	61
	*1	BATNUM1	61
	2	BATNUM2	61
	3	BATNUM3	61
	4	BATNUM4	61
	5	BATNUM5	61
	6	BATNUM6	61
	7	BATNUM7	61
	8	BATNUM8	61
	9	BATNUM9	61
Batch Mode Output Order	*FIFO	BATLIFO	62
	LIFO	BATLIF1	62
Total Records	Total Records	BATNRC	62
Delete Last Code	Delete Last Code	BATUND	62
Clear All Codes	Clear All Codes	BATCLR	62
Transmit Records to Host	Transmit Inventory Records	BAT_TX	63
Batch Mode Transmit Delay	*Off (No Delay)	BATDLY0	63
	Short (250 ms)	BATDLY250	63
	Medium (500 ms)	BATDLY500	63
	Long (1000 ms)	BATDLY1000	63
Multiple Scanner Operation	Multiple Scanner Operation	BASCON2,DNG3	64
Scanner Name	0001	BT_NAM0001	64
	0002	BT_NAM0002	64
	0003	BT_NAM0003	64
	Reset	RESET_	64
	Scanner Name	BT_NAM	65
Application Work Group Selections	*Group 0	GRPSELO	65
	Group 1	GRPSEL1	66
	Group 2	GRPSEL2	66
Reset the Factory Defaults: All Application Work Groups	Factory Default Settings: All Work Groups	PAPDFT&	66
Reset the Custom Defaults: All Application Work Groups	Custom Default Settings: All Work Groups	PAPDFT	67
Bluetooth Connection	*Bluetooth SSP On	BT_SSP1	67
	Bluetooth SSP Off	BT_SSP0	67

<b>Selection</b>	<b>Setting * Indicates default</b>	<b>Serial Command # Indicates a numeric entry</b>	<b>Page</b>
	Bluetooth HID Keyboard Connect	PAPBTH	68
	Bluetooth HID Japanese Keyboard Connect	PAPJKB	68
	Bluetooth HID Keyboard Disconnect	PAPSPP	70
Pair with Bluetooth Low Energy (BLE) Devices	HID BLE Connect	PAPLEH	70
	Serial BLE Connect	PAPTIO	70
Bluetooth Serial Port - PCs/ Laptops	Non-Base BT Connection	BT_TRM0;BT_DNG5	71
PDA's/Mobility Systems Devices	BT Connection - PDA/Mobility Systems Device	BT_TRM0;BT_DNG1	71
Change the Scanner's Bluetooth PIN Code	Bluetooth PIN Code	BT_PIN	71
Auto Reconnect Mode	*Auto Reconnect On	BT_ACM1	72
	Auto Reconnect Off	BT_ACM0	72
Maximum Link Attempts	Maximum Link Attempts (0-100) *0	BT_MLA###	73
Relink Time-Out	Relink Time-Out (1-100) *3	BT_RLT###	73
Host Command Acknowledgment	Host ACK On	HSTACK1	76
	*Host ACK Off	HSTACK0	76
	Host ACK Timeout (1-90) *10	HSTATO##	76
<b>Input/Output Selections</b>			
Power Up Beeper	Power Up Beeper Off - Scanner	BEPPWRO	77
	*Power Up Beeper On - Scanner	BEPPWR1	77
	Power Up Beeper Off - Cordless Base	BASPWRO	77
	Power Up Beeper On - Cordless Base	BASPWR1	77
Beep on BEL Character	Beep on BEL On	BELBEP1	78
	*Beep on BEL Off	BELBEPO	78
Trigger Click	On	BEPTRG1	78
	*Off	BEPTRG0	78
Beeper - Good Read	Off	BEPBEPO	78
	*On	BEPBEP1	78
Beeper Volume - Good Read	Off	BEPLVLO	78
	*Low	BEPLVL1	79
	Medium	BEPLVL2	79
	*High (Default - Granit XP)	BEPLVL3	79
Beeper Pitch - Good Read (Frequency)	Low (1600 Hz) (min 400 Hz)	BEPFQ11600	79

<b>Selection</b>	<b>Setting * Indicates default</b>	<b>Serial Command # Indicates a numeric entry</b>	<b>Page</b>
	*Medium (2700 Hz)	BEPFQ12700	<a href="#">79</a>
	High (4200 Hz) (max 9000 Hz)	BEPFQ14200	<a href="#">79</a>
Vibrate - Good Read	*Vibrate - Good Read Off	TFBGRD0	<a href="#">80</a>
	Vibrate - Good Read On	TFBGRD1	<a href="#">80</a>
Vibrate Duration	Duration (100 - 2,000 ms) *100	TFBDUR####	<a href="#">80</a>
Beeper Pitch - Error (Frequency)	*Razz (250 Hz) (min 200 Hz)	BEPFQ2800	<a href="#">80</a>
	Medium (3250 Hz)	BEPFQ23250	<a href="#">80</a>
	High (4200 Hz) (max 9000 Hz)	BEPFQ24200	<a href="#">80</a>
Beeper Duration - Good Read	*Normal Beep	BEPBIP0	<a href="#">81</a>
	Short Beep	BEPBIP1	<a href="#">81</a>
LED - Good Read	Off	BEPLED0	<a href="#">81</a>
	*On	BEPLED1	<a href="#">81</a>
Number of Beeps - Good Read	(Range 1 - 9) *1	BEPRPT#	<a href="#">81</a>
Number of Beeps - Error	(Range 1 - 9) *1	BEPERR#	<a href="#">81</a>
Good Read Delay	*No Delay	DLYGRD0	<a href="#">82</a>
	Short Delay (500 ms)	DLYGRD500	<a href="#">82</a>
	Medium Delay (1000 ms)	DLYGRD1000	<a href="#">82</a>
	Long Delay (1500 ms)	DLYGRD1500	<a href="#">82</a>
User-Specified Good Read Delay	Range 0 - 30,000 ms	DLYGRD#####	<a href="#">82</a>
Trigger Modes	*Manual Trigger - Normal	PAPHHF	<a href="#">83</a>
	Manual Trigger - Enhanced	PAPHHS	<a href="#">83</a>
Trigger Toggle	*Trigger Toggle Off	TRGTGM0	<a href="#">83</a>
	Trigger Toggle - Image Capture	TRGTGM1	<a href="#">83</a>
	Trigger Toggle Off - Centering	TRGTGM3	<a href="#">83</a>
Trigger Number	2 Quick Triggers	TRGTPC2	<a href="#">84</a>
	3 Quick Triggers	TRGTPC3	<a href="#">84</a>
	4 Quick Triggers	TRGTPC4	<a href="#">84</a>
Trigger Timing	Trigger Timing (Range 50 - 2000) *400	TRGTTI####	<a href="#">84</a>
Trigger Toggle Timeout	Trigger Toggle Timeout (Range 0 - 65) *5	TRGTGT##	<a href="#">84</a>
Serial Trigger Mode	Read Time-Out (0 - 300,000 ms) *30,000	TRGSTO####	<a href="#">85</a>
Presentation Mode	Presentation Mode	PAPTPR	<a href="#">86</a>
Triggered Presentation Mode	Ambient Light Only	PDCLED0	<a href="#">86</a>
	*Ambient and Scanner Light	PDCLED1	<a href="#">86</a>
Presentation LED Behavior After Decode	*LEDs On	TRGPCK1	<a href="#">86</a>
	LEDs Off	TRGPCK0	<a href="#">86</a>

<b>Selection</b>	<b>Setting * Indicates default</b>	<b>Serial Command # Indicates a numeric entry</b>	<b>Page</b>
Presentation Centering Window	Presentation Centering On	PDCWIN1	88
	*Presentation Centering Off	PDCWIN0	88
	Left of Presentation Centering Window (*40%)	PDCLFT###	88
	Right of Presentation Centering Window (*60%)	PDCRGT###	88
	Top of Presentation Centering Window (*40%)	PDCTOP###	88
	Bottom of Presentation Centering Window (*60%)	PDCBOT###	88
Poor Quality Codes	Poor Quality 1D Reading On	DECLDI1	90
	*Poor Quality 1D Reading Off	DECLDI0	90
	*Poor Quality PDF Reading On	PDFXPR10	90
	Poor Quality PDF Reading Off	PDFXPRO	90
	Low Resolution PDF Codes On	PDFDMI1	90
	*Low Resolution PDF Codes Off	PDFDMI0	90
CodeGate	*CodeGate Off	AOSCGD0.	91
	CodeGate On	AOSCGD1.	91
Streaming Presentation	Streaming Presentation Mode - Normal	PAPSPN	91
	Streaming Presentation Mode - Enhanced	PAPSPE	91
Hands Free Time-Out	Range (0 - 300,000 ms) 5000 ms	TRGPT0#####	92
Reread Delay	Short (500 ms)	DLYRRD500	92
	*Medium (750 ms)	DLYRRD750	92
	Long (1000 ms)	DLYRRD1000	92
	Extra Long (2000 ms)	DLYRRD2000	92
User-Specified	Range 0 - 30,000 ms	DLYRRD#####	93
2D Reread Delay	*2D Reread Delay Off	DLY2RRO	93
	Short (1000ms)	DLY2RR1000	93
	Medium (2000ms)	DLY2RR2000	93
	Long (3000ms)	DLY2RR3000	93
	Extra Long (4000ms)	DLY2RR4000	93



<b>Selection</b>	<b>Setting * Indicates default</b>	<b>Serial Command # Indicates a numeric entry</b>	<b>Page</b>
Character Activation Mode	*Off	HSTCEN0	93
	On	HSTCEN1	93
	Activation Character (Range 0-255) *12 [DC2]	HSTACH###	94
	Do Not End Character Activation After Good Read	HSTCGD0	94
	End Character Activation After Good Read	HSTCGD1	94
	Character Activation Timeout (Range 1 - 300,000) *30,000 ms	HSTCDT#####	95
Character Deactivation Mode	*Off	HSTDEN0	95
	On	HSTDEN1	95
	Deactivation Character (Range 0-255) *14 [DC4]	HSTDCH###	95
Illumination Lights	*Lights On	SCNLED1	96
	Lights Off	SCNLED0	96
Aimer Delay	1 millisecond	SCNDLY1	96
	250 milliseconds	SCNDLY250	96
	500 milliseconds	SCNDLY500	96
	*Off (no delay)	SCNDLY0	96
User-Specified Aimer Delay	Range 0 - 4,000 ms	SCNDLY####	97
Aimer Mode	Off	SCNAIM0	97
	*Interlaced	SCNAIM2	97
Single Code Centering	Single Code Centering	DECWIN1;DECTOP49;DECBOT51;DECRGT51;DECLFT49	98
Centering Window	Centering On	DECWIN1	99
	*Centering Off	DECWIN0	99
	Left of Centering Window (*40%)	DECLFT###	100
	Right of Centering Window (*60%)	DECRGT###	100
	Top of Centering Window (*40%)	DECTOP###	99
	Bottom of Centering Window (*60%)	DECBOT###	100
Preferred Symbology	On	PRFENA1	100
	*Off	PRFENA0	100
	High Priority Symbology	PRFCOD##	101
	Low Priority Symbology	PRFBLK##	101
	Preferred Symbology Timeout (Range 100-3000) *500	PRFPTO####	101
	Preferred Symbology Default	PRFDFT	101

<b>Selection</b>	<b>Setting * Indicates default</b>	<b>Serial Command # Indicates a numeric entry</b>	<b>Page</b>
Output Sequence Editor	Enter Output Sequence	SEQBLK	103
	Add Prefix to Complete Output Sequences	SEQPRE	103
	Add Suffix to Complete Output Sequences	SEQSUF	103
	Add Separators to Complete Output Sequences	SEQSEP	103
	Terminate String	FF	103
Partial Sequence	Transmit Partial Output Sequence	SEQTTS1	103
	Add Prefix to Partial Output Sequences	SEQIPR	103
	Add Suffix to Partial Output Sequences	SEQISU	103
	Add Separators to Partial Output Sequences	SEQISE	103
	Terminate String	FF	103
	Define Satisfactory Subsets	SEQSAT	103
	Timeout for SEQSAT	SEQTIM	103
	*Discard Partial Output Sequence	SEQTTS0	107
	Default Output Sequence	SEQDFT	109
Require Output Sequence	Required	SEQ_EN2	109
	On/Not Required	SEQ_EN1	109
	*Off	SEQ_EN0	109
Good Read Tone - Output Sequences	Good Read Beep - Each Code in Sequence	BEPSIN0	110
	*Good Read Click - Each Code in Sequence	BEPSIN1	110
	Good Read Beep - Partial Sequence Output	BEPISE0	110
	*Error Tone - Partial Sequence Output	BEPISE1	110
Multiple Symbols	On	SHOTGN1	109
	*Off	SHOTGN0	109
No Read	On	SHWNRD1	111
	*Off	SHWNRD0	111
Video Reverse	Video Reverse Only	VIDREV1	111
	Video Reverse and Standard Barcodes	VIDREV2	111
	*Video Reverse Off	VIDREVO	112

<b>Selection</b>	<b>Setting * Indicates default</b>	<b>Serial Command # Indicates a numeric entry</b>	<b>Page</b>
Working Orientation	*Upright	ROTATN0	<a href="#">112</a>
	Vertical, Bottom to Top (Rotate CCW 90°)	ROTATN1	<a href="#">112</a>
	Upside Down	ROTATN2	<a href="#">112</a>
	Vertical, Top to Bottom (Rotate CW 90°)	ROTATN3	<a href="#">112</a>
<b>Quiet Operations - LED and Volume Settings</b>			
Linking LED Colors and Sound	*Green LED Flashes/Sound	BEPPAR1	<a href="#">121</a>
	Red LED Flashes/Silent	BEPPAR0	<a href="#">121</a>
Number of LED Flashes	*1 LED Flash	BEPLFN0	<a href="#">122</a>
	5 LED Flashes	BEPLFN5	<a href="#">122</a>
	10 LED Flashes	BEPLFN10	<a href="#">122</a>
	25 LED Flashes	BEPLFN25	<a href="#">122</a>
LED Flash Rate	*Fast Flash	BEPLFR50	<a href="#">122</a>
	Medium Flash	BEPLFR250	<a href="#">122</a>
	Slow Flash	BEPLFR500	<a href="#">122</a>
LED Solid (No Flash)	*LED Solid Off (Resume Flash)	BEPL0T0	<a href="#">123</a>
	LED Solid 1 Second	BEPL0T1	<a href="#">123</a>
	LED Solid 3 Seconds	BEPL0T3	<a href="#">123</a>
	LED Solid 5 Seconds	BEPL0T5	<a href="#">123</a>
Page Volume Control	Page Volume Off	BEPPGV0	<a href="#">123</a>
	*Page Volume Low	BEPPGV1	<a href="#">123</a>
	Page Volume Medium	BEPPGV2	<a href="#">124</a>
	Page Volume High	BEPPGV3	<a href="#">124</a>
Out-of-Range Alarm Volume	Base Alarm Volume Off	BASORV0	<a href="#">124</a>
	Scanner Alarm Volume Off	BT_ORV0	<a href="#">124</a>
	*Base Alarm Volume Low	BASORV1	<a href="#">124</a>
	*Scanner Alarm Volume Low	BT_ORV1	<a href="#">124</a>
	Base Alarm Volume Medium	BASORV2	<a href="#">124</a>
	Scanner Alarm Volume Medium	BT_ORV2	<a href="#">125</a>
	Base Alarm Volume High	BASORV3	<a href="#">125</a>
	Scanner Alarm Volume High	BT_ORV3	<a href="#">125</a>
Out-of-Range Delay	Out-of-Range Delay (Range 0-3000) *0	BT_ORY####	<a href="#">125</a>
<b>Prefix/Suffix Selections</b>			
Add CR Suffix to All Symbolologies		VSUF CR	<a href="#">115</a>

<b>Selection</b>	<b>Setting * Indicates default</b>	<b>Serial Command # Indicates a numeric entry</b>	<b>Page</b>
Prefix	Add Prefix	PREBK2##	115
	Clear One Prefix	PRECL2	115
	Clear All Prefixes	PRECA2	115
Suffix	Add Suffix	SUFBK2##	115
	Clear One Suffix	SUFCL2	115
	Clear All Suffixes	SUFCA2	115
Function Code Transmit	*Enable	RMVFNC0	116
	Disable	RMVFNC1	116
Intercharacter Delay	Range 0 - 5000 (5ms increments)	DLYCHR####	116
User Specified Intercharacter Delay	Delay Length 0 - 5000 (5ms increments)	DLYCRX####	117
	Character to Trigger Delay	DLY_XX##	117
Interfunction Delay	Range 0 - 5000 (5ms increments)	DLYFNC####	117
Intermessage Delay	Range 0 - 5000 (5ms increments)	DLYMSG####	118
<b>Data Formatter Selections</b>			
Data Format Editor	*Default Data Format (None)	DFMDF3	120
	Show Data Format Settings	DFMBK3?	120
	Enter Data Format	DFMBK3##	121
	Clear One Data Format	DFMCL3	121
	Clear All Data Formats	DFMCA3	121
Data Formatter	Data Formatter Off	DFM_EN0	135
	*Data Formatter On, Not Required, Keep Prefix/Suffix	DFM_EN1	136
	Data Format Required, Keep Prefix/Suffix	DFM_EN2	136
	Data Formatter On, Not Required, Drop Prefix/Suffix	DFM_EN3	136
	Data Format Required, Drop Prefix/Suffix	DFM_EN4	136
Data Format Non-Match Error Tone	*Data Format Non-Match Error Tone On	DFMDEC0	136
	Data Format Non-Match Error Tone Off	DFMDEC1	137
Primary/Alternate Data Formats	Primary Data Format	ALTFNM0	137
	Data Format 1	ALTFNM1	137
	Data Format 2	ALTFNM2	137
	Data Format 3	ALTFNM3	137

<b>Selection</b>	<b>Setting * Indicates default</b>	<b>Serial Command # Indicates a numeric entry</b>	<b>Page</b>
Single Scan Data Format Change	Single Scan-Primary Data Format	VSAF_0	<a href="#">137</a>
	Single Scan-Data Format 1	VSAF_1	<a href="#">138</a>
	Single Scan-Data Format 2	VSAF_2	<a href="#">138</a>
	Single Scan-Data Format 3	VSAF_3	<a href="#">138</a>
<b>Symbologies</b>			
All Symbologies	All Symbologies Off	ALLENA0	<a href="#">140</a>
Codabar	Default All Codabar Settings	CBRDFT	<a href="#">140</a>
	Off	CBRENA0	<a href="#">140</a>
	*On	CBRENA1	<a href="#">140</a>
Codabar Start/Stop Char.	*Don't Transmit	CBRSSX0	<a href="#">141</a>
	Transmit	CBRSSX1	<a href="#">141</a>
Codabar Check Char.	*No Check Char.	CBRCK20	<a href="#">141</a>
	Validate, But Don't Transmit	CBRCK21	<a href="#">141</a>
	Validate, and Transmit	CBRCK22	<a href="#">141</a>
Codabar Concatenation	*Off	CBRCCT0	<a href="#">142</a>
	On	CBRCCT1	<a href="#">142</a>
	Require	CBRCCT2	<a href="#">142</a>
Codabar Message Length	Minimum (2 - 60) *4	CBRMIN##	<a href="#">142</a>
	Maximum (2 - 60) *60	CBRMAX##	<a href="#">142</a>
Code 39	Default All Code 39 Settings	C39DFT	<a href="#">143</a>
	Off	C39ENA0	<a href="#">143</a>
	*On	C39ENA1	<a href="#">143</a>
Code 39 Start/Stop Char.	*Don't Transmit	C39SSX0	<a href="#">143</a>
	Transmit	C39SSX1	<a href="#">143</a>
Code 39 Check Char.	*No Check Char.	C39CK20	<a href="#">143</a>
	Validate, But Don't Transmit	C39CK21	<a href="#">143</a>
	Validate, and Transmit	C39CK22	<a href="#">143</a>
Code 39 Message Length	Minimum (0 - 48) *0	C39MIN##	<a href="#">144</a>
	Maximum (0 - 48) *48	C39MAX##	<a href="#">144</a>
Code 39 Append	*Off	C39APP0	<a href="#">144</a>
	On	C39APP1	<a href="#">144</a>
Code 32 Pharmaceutical (PARAF)	*Off	C39B320	<a href="#">145</a>
	On	C39B321	<a href="#">145</a>

<b>Selection</b>	<b>Setting * Indicates default</b>	<b>Serial Command # Indicates a numeric entry</b>	<b>Page</b>
Code 39 Full ASCII	*Off	C39ASC0	145
	On	C39ASC1	145
	Code 39 Code Page	C39DCP	145
Interleaved 2 of 5	Default All Interleaved 2 of 5 Settings	I25DFT	146
	Off	I25ENAO	146
	*On	I25ENA1	146
Interleaved 2 of 5 Check Digit	*No Check Digit	I25CK20	146
	Validate, But Don't Transmit	I25CK21	146
	Validate and Transmit	I25CK22	146
Interleaved 2 of 5 Message Length	Minimum (2 - 80) *4	I25MIN##	147
	Maximum (2 - 80) *80	I25MAX##	147
	*FEBRABAN Decode Off	I25PAY0	147
	FEBRABAN Decode On	I25PAY1	147
NEC 2 of 5	Default All NEC 2 of 5 Settings	N25DFT	148
	Off	N25ENAO	148
	*On	N25ENA1	148
NEC 2 of 5 Check Digit	*No Check Digit	N25CK20	148
	Validate, But Don't Transmit	N25CK21	148
	Validate and Transmit	N25CK22	148
NEC 2 of 5 Message Length	Minimum (2 - 80) *4	N25MIN##	149
	Maximum (2 - 80) *80	N25MAX##	149
Code 93	Default All Code 93 Settings	C93DFT	149
	Off	C93ENAO	149
	*On	C93ENA1	149
Code 93 Message Length	Minimum (0 - 80) *0	C93MIN##	149
	Maximum (0 - 80) *80	C93MAX##	149
Code 93 Append	On	C93APP1	150
	*Off	C93APP0	150
Code 93 Code Page	Code 93 Code Page	C93DCP	150
Straight 2 of 5 Industrial	Default All Straight 2 of 5 Industrial Settings	R25DFT	151
	*Off	R25ENAO	151
	On	R25ENA1	151

<b>Selection</b>	<b>Setting * Indicates default</b>	<b>Serial Command # Indicates a numeric entry</b>	<b>Page</b>
Straight 2 of 5 Industrial Message Length	Minimum (1 - 48) *4	R25MIN##	<a href="#">151</a>
	Maximum (1 - 48) *48	R25MAX##	<a href="#">151</a>
Straight 2 of 5 IATA	Default All Straight 2 of 5 IATA Settings	A25DFT	<a href="#">152</a>
Straight 2 of 5 IATA	*Off	A25ENAO	<a href="#">152</a>
	On	A25ENA1	<a href="#">152</a>
Straight 2 of 5 IATA Redundancy	Range (0 - 10) *0	A25VOT##	<a href="#">152</a>
Straight 2 of 5 IATA Message Length	Minimum (1 - 48) *4	A25MIN##	<a href="#">152</a>
	Maximum (1 - 48) *48	A25MAX##	<a href="#">152</a>
Matrix 2 of 5	Default All Matrix 2 of 5 Settings	X25DFT	<a href="#">153</a>
	*Off	X25ENAO	<a href="#">153</a>
	On	X25ENA1	<a href="#">153</a>
Matrix 2 of 5 Message Length	Minimum (1 - 80) *4	X25MIN##	<a href="#">153</a>
	Maximum (1 - 80) *80	X25MAX##	<a href="#">153</a>
Code 11	Default All Code 11 Settings	C11DFT	<a href="#">154</a>
	*Off	C11ENAO	<a href="#">154</a>
	On	C11ENA1	<a href="#">154</a>
Code 11 Check Digits Required	1 Check Digit	C11CK20	<a href="#">154</a>
	*2 Check Digits	C11CK21	<a href="#">154</a>
Code 11 Message Length	Minimum (1 - 80) *4	C11MIN##	<a href="#">154</a>
	Maximum (1 - 80) *80	C11MAX##	<a href="#">154</a>
Code 128	Default All Code 128 Settings	128DFT	<a href="#">155</a>
	Off	128ENAO	<a href="#">155</a>
	*On	128ENA1	<a href="#">155</a>
ISBT Concatenation	*Off	ISBENAO	<a href="#">155</a>
	On	ISBENA1	<a href="#">155</a>
Code 128 Redundancy	Range (0 - 10) *0	128VOT##	<a href="#">155</a>
Code 128 Message Length	Minimum (0 - 80) *0	128MIN##	<a href="#">156</a>
	Maximum (0 - 80) *80	128MAX##	<a href="#">156</a>
Code 128 Append	On	128APP1	<a href="#">156</a>
	*Off	128APPO	<a href="#">156</a>
Code 128 Code Page	Code 128 Code Page (*2)	128DCP##	<a href="#">156</a>
GS1-128	Default All GS1-128 Settings	GS1DFT	<a href="#">157</a>
	*On	GS1ENA1	<a href="#">157</a>
	Off	GS1ENAO	<a href="#">157</a>

<b>Selection</b>	<b>Setting * Indicates default</b>	<b>Serial Command # Indicates a numeric entry</b>	<b>Page</b>
GS1-128 Message Length	Minimum (1 - 80) *1	GS1MIN##	<a href="#">157</a>
	Maximum (0 - 80) *80	GS1MAX##	<a href="#">157</a>
Telepen	Default All Telepen Settings	TELDFT	<a href="#">158</a>
	*Off	TELENA0	<a href="#">158</a>
	On	TELENA1	<a href="#">158</a>
Telepen Output	*AIM Telepen Output	TELOLD0	<a href="#">158</a>
	Original Telepen Output	TELOLD1	<a href="#">158</a>
Telepen Message Length	Minimum (1 - 60) *1	TELMIN##	<a href="#">158</a>
	Maximum (1 - 60) *60	TELMAX##	<a href="#">158</a>
UPC-A	Default All UPC-A Settings	UPADFT	<a href="#">159</a>
	Off	UPBENA0	<a href="#">159</a>
	*On	UPBENA1	<a href="#">159</a>
UPC-A Check Digit	Off	UPACKX0	<a href="#">159</a>
	*On	UPACKX1	<a href="#">159</a>
UPC-A Number System	Off	UPANSX0	<a href="#">159</a>
	*On	UPANSX1	<a href="#">159</a>
UPC-A 2 Digit Addenda	*Off	UPAAD20	<a href="#">160</a>
	On	UPAAD21	<a href="#">160</a>
UPC-A 5 Digit Addenda	*Off	UPAAD50	<a href="#">160</a>
	On	UPAAD51	<a href="#">160</a>
UPC-A Addenda Required	*Not Required	UPAARQ0	<a href="#">160</a>
	Required	UPAARQ1	<a href="#">160</a>
Addenda Timeout	Range (0 - 120) *500	DLYADD#####	<a href="#">160</a>
UPC-A Addenda Separator	Off	UPAADS0	<a href="#">161</a>
	*On	UPAADS1	<a href="#">161</a>
UPC-A/EAN-13 with Extended Coupon Code	*Off	CPNENA0	<a href="#">161</a>
	Allow Concatenation	CPNENA1	<a href="#">161</a>
	Require Concatenation	CPNENA2	<a href="#">161</a>
Addenda Timeout	Range (0 - 120) *500	DLYADD#####	<a href="#">161</a>
Coupon GS1 DataBar Output	*GS1 Output Off	CPNGS10	<a href="#">162</a>
	GS1 Output On	CPNGS11	<a href="#">162</a>
UPC-E0	Default All UPC-E Settings	UPEDFT	<a href="#">162</a>
	Off	UPEEN00	<a href="#">162</a>
	*On	UPEEN01	<a href="#">162</a>



<b>Selection</b>	<b>Setting * Indicates default</b>	<b>Serial Command # Indicates a numeric entry</b>	<b>Page</b>
UPC-E0 Expand	*Off	UPEEXP0	<a href="#">163</a>
	On	UPEEXP1	<a href="#">163</a>
UPC-E0 Addenda Required	Required	UPEARQ1	<a href="#">163</a>
	*Not Required	UPEARQ0	<a href="#">163</a>
Addenda Timeout	Range (0 - 120) *500	DLYADD#####	<a href="#">163</a>
UPC-E0 Addenda Separator	*On	UPEADS1	<a href="#">164</a>
	Off	UPEADS0	<a href="#">164</a>
UPC-E0 Check Digit	Off	UPECKX0	<a href="#">164</a>
	*On	UPECKX1	<a href="#">164</a>
UPC-E0 Leading Zero	Off	UPENSX0	<a href="#">164</a>
	*On	UPENSX1	<a href="#">164</a>
UPC-E0 Addenda	2 Digit Addenda On	UPEAD21	<a href="#">165</a>
	*2 Digit Addenda Off	UPEAD20	<a href="#">165</a>
	5 Digit Addenda On	UPEAD51	<a href="#">165</a>
	*5 Digit Addenda Off	UPEAD50	<a href="#">165</a>
UPC-E1	*Off	UPEEN10	<a href="#">165</a>
	On	UPEEN11	<a href="#">165</a>
EAN/JAN-13	Default All EAN/ JAN Settings	E13DFT	<a href="#">166</a>
	Off	E13ENAO	<a href="#">166</a>
	*On	E13ENA1	<a href="#">166</a>
Convert UPC-A to EAN-13	UPC-A Converted to EAN-13	UPAENAO	<a href="#">166</a>
	*Do not Convert UPC-A	UPAENA1	<a href="#">166</a>
EAN/JAN-13 Check Digit	Off	E13CKX0	<a href="#">166</a>
	*On	E13CKX1	<a href="#">166</a>
EAN/JAN-13 Addenda	2 Digit Addenda On	E13AD21	<a href="#">167</a>
	*2 Digit Addenda Off	E13AD20	<a href="#">167</a>
	5 Digit Addenda On	E13AD51	<a href="#">167</a>
	*5 Digit Addenda Off	E13AD50	<a href="#">167</a>
EAN/JAN-13 Addenda Required	*Not Required	E13ARQ0	<a href="#">167</a>
	Required	E13ARQ1	<a href="#">167</a>
EAN-13 Beginning with 290 Addenda Required	*Don't Require 5 Digit Addenda	ARQ2900	<a href="#">167</a>
	Require 5 Digit Addenda	ARQ2901	<a href="#">167</a>
EAN-13 Beginning with 378/379 Addenda Required	*Don't Require Addenda	ARQ3780	<a href="#">168</a>
	Require 2 Digit Addenda	ARQ3781	<a href="#">168</a>
	Require 5 Digit Addenda	ARQ3782	<a href="#">168</a>
	Require 2 or 5 Digit Addenda	ARQ3783	<a href="#">168</a>

<b>Selection</b>	<b>Setting * Indicates default</b>	<b>Serial Command # Indicates a numeric entry</b>	<b>Page</b>
EAN-13 Beginning with 414/419 Addenda Required	*Don't Require Addenda	ARQ4140	<a href="#">169</a>
	Require 2 Digit Addenda	ARQ4141	<a href="#">169</a>
	Require 5 Digit Addenda	ARQ4142	<a href="#">169</a>
	Require 2 or 5 Digit Addenda	ARQ4143	<a href="#">169</a>
EAN-13 Beginning with 434/439 Addenda Required	*Don't Require Addenda	ARQ4340	<a href="#">169</a>
	Require 2 Digit Addenda	ARQ4341	<a href="#">169</a>
	Require 5 Digit Addenda	ARQ4342	<a href="#">169</a>
	Require 2 or 5 Digit Addenda	ARQ4343	<a href="#">169</a>
EAN-13 Beginning with 977 Addenda Required	*Don't Require 2 Digit Addenda	ARQ9770	<a href="#">170</a>
	Require 2 Digit Addenda	ARQ9771	<a href="#">170</a>
EAN-13 Beginning with 978 Addenda Required	*Don't Require 5 Digit Addenda	ARQ9780	<a href="#">170</a>
	Require 5 Digit Addenda	ARQ9781	<a href="#">170</a>
EAN-13 Beginning with 979 Addenda Required	*Don't Require 5 Digit Addenda	ARQ9790	<a href="#">171</a>
	Require 5 Digit Addenda	ARQ9791	<a href="#">171</a>
Addenda Timeout	Range (0 - 120) *500	DLYADD#####	<a href="#">172</a>
EAN/JAN-13 Addenda Separator	Off	E13ADS0	<a href="#">172</a>
	*On	E13ADS1	<a href="#">172</a>
ISBN Translate	*Off	E13ISB0	<a href="#">172</a>
	On	E13ISB1	<a href="#">172</a>
EAN/JAN-8	Default All EAN/ JAN-8 Settings	EA8DFT	<a href="#">173</a>
	Off	EA8ENAO	<a href="#">173</a>
	*On	EA8ENA1	<a href="#">173</a>
EAN/JAN-8 Check Digit	Off	EA8CKX0	<a href="#">173</a>
	*On	EA8CKX1	<a href="#">173</a>
EAN/JAN-8 Addenda	*2 Digit Addenda Off	EA8AD20	<a href="#">173</a>
	2 Digit Addenda On	EA8AD21	<a href="#">173</a>
	*5 Digit Addenda Off	EA8AD50	<a href="#">173</a>
	5 Digit Addenda On	EA8AD51	<a href="#">173</a>
EAN/JAN-8 Addenda Required	*Not Required	EA8ARQ0	<a href="#">174</a>
	Required	EA8ARQ1	<a href="#">174</a>
Addenda Timeout	Range (0 - 120) *500	DLYADD#####	<a href="#">174</a>
EAN/JAN-8 Addenda Separator	Off	EA8ADS0	<a href="#">174</a>
	*On	EA8ADS1	<a href="#">174</a>
MSI	Default All MSI Settings	MSIDFT	<a href="#">175</a>
	*Off	MSIENAO	<a href="#">175</a>
	On	MSIENA1	<a href="#">175</a>

<b>Selection</b>	<b>Setting * Indicates default</b>	<b>Serial Command # Indicates a numeric entry</b>	<b>Page</b>
MSI Check Character	*Validate Type 10, but Don't Transmit	MSICHK0	<a href="#">175</a>
	Validate Type 10 and Transmit	MSICHK1	<a href="#">175</a>
	Validate 2 Type 10 Chars, but Don't Transmit	MSICHK2	<a href="#">176</a>
	Validate 2 Type 10 Chars and Transmit	MSICHK3	<a href="#">176</a>
	Validate Type 11 then Type 10 Char, but Don't Transmit	MSICHK4	<a href="#">176</a>
	Validate Type 11 then Type 10 Char and Transmit	MSICHK5	<a href="#">176</a>
	Disable MSI Check Characters	MSICHK6	<a href="#">176</a>
MSI Message Length	Minimum (4 - 48) *4	MSIMIN##	<a href="#">176</a>
	Maximum (4 - 48) *48	MSIMAX##	<a href="#">176</a>
GS1 DataBar Omnidirectional	Default All GS1 DataBar Omnidirectional Settings	RSSDFT	<a href="#">177</a>
	Off	RSENA0	<a href="#">177</a>
	*On	RSENA1	<a href="#">177</a>
GS1 DataBar Limited	Default All GS1 DataBar Limited Settings	RSLDFT	<a href="#">177</a>
	Off	RSENA0	<a href="#">177</a>
	*On	RSENA1	<a href="#">177</a>
GS1 DataBar Expanded	Default All GS1 DataBar Expanded Settings	RSEDFT	<a href="#">178</a>
	Off	RSEENA0	<a href="#">178</a>
	*On	RSEENA1	<a href="#">178</a>
GS1 DataBar Expanded Msg. Length	Minimum (4 - 74) *4	RSEMIN##	<a href="#">178</a>
	Maximum (4 - 74) *74	RSEMAX##	<a href="#">178</a>
Trioptic Code	*Off	TRIENA0	<a href="#">178</a>
	On	TRIENA1	<a href="#">178</a>
Codablock A	Default All Codablock A Settings	CBADFT	<a href="#">179</a>
	*Off	CBAENA0	<a href="#">179</a>
	On	CBAENA1	<a href="#">179</a>
Codablock A Msg. Length	Minimum (1 - 600) *1	CBAMIN###	<a href="#">179</a>
	Maximum (1 - 600) *600	CBAMAX###	<a href="#">179</a>
Codablock F	Default All Codablock F Settings	CBFDFT	<a href="#">180</a>
	*Off	CBFENA0	<a href="#">180</a>
	On	CBFENA1	<a href="#">180</a>

<b>Selection</b>	<b>Setting * Indicates default</b>	<b>Serial Command # Indicates a numeric entry</b>	<b>Page</b>
Codablock F Msg. Length	Minimum (1 - 2048) *1	CBFMIN####	180
	Maximum (1 - 2048) *2048	CBFMAX####	180
Label Code	On	LBLENA1	180
	*Off	LBLENA0	180
PDF417	Default All PDF417 Settings	PDFDFT	181
	*On	PDFENA1	181
	Off	PDFENA0	181
PDF417 Msg. Length	Minimum (1-2750) *1	PDFMIN####	181
	Maximum (1-2750) *2750	PDFMAX####	181
MacroPDF417	*On	PDFMAC1	182
	Off	PDFMAC0	182
MicroPDF417	Default All Micro PDF417 Settings	MPDDFT	182
	On	MPDENA1	182
	*Off	MPDENA0	182
MicroPDF417 Msg. Length	Minimum (1-366) *1	MPDMIN###	182
	Maximum (1-366) *366	MPDMAX###	182
GS1 Composite Codes	On	COMENA1	182
	*Off	COMENA0	182
UPC/EAN Version	On	COMUPC1	183
	*Off	COMUPC0	183
GS1 Composite Codes Msg. Length	Minimum (1-2435) *1	COMMIN####	183
	Maximum (1-2435) *2435	COMMAX####	183
GS1 Emulation	GS1-128 Emulation	EANEMU1	183
	GS1 DataBar Emulation	EANEMU2	182
	GS1 Code Expansion Off	EANEMU3	184
	EAN8 to EAN13 Conversion	EANEMU4	184
	*GS1 Emulation Off	EANEMU0	184
TCIF Linked Code 39	On	T39ENA1	184
	*Off	T39ENA0	184
QR Code	Default All QR Code Settings	QRCDFT	185
	*On	QRCENA1	185
	Off	QRCENA0	185
QR Code Msg. Length	Minimum (1-7089) *1	QRCMIN####	185
	Maximum (1-7089) *7089	QRCMAX####	185

<b>Selection</b>	<b>Setting * Indicates default</b>	<b>Serial Command # Indicates a numeric entry</b>	<b>Page</b>
QR Code Append	*One Scan	QRCAPP1	<a href="#">185</a>
	Swipe	QRCAPP2	<a href="#">185</a>
	Point & Shoot	QRCAPP3	<a href="#">185</a>
	Off	QRCAPP0	<a href="#">185</a>
QR Code Page	QR Code Page (*3)	QRCDCP##	<a href="#">186</a>
DotCode	Default All DotCode Settings	DOTDFT	<a href="#">187</a>
	On	DOTENA1	<a href="#">187</a>
	*Off	DOTENA0	<a href="#">187</a>
Poor Quality DotCodes	Poor Quality DotCodes On	DOTEXS1	<a href="#">187</a>
	*Poor Quality DotCodes Off	DOTEXS0	<a href="#">187</a>
DotCode Msg. Length	Minimum (1- 2400) *1	DOTMIN####	<a href="#">188</a>
	Maximum (1- 2400) *2400	DOTMAX####	<a href="#">188</a>
Digimarc Barcode	Decoder Attempts (0-10) *3	DIGSTR##	<a href="#">188</a>
	Off	DIGENA0	<a href="#">188</a>
	On	DIGENA1	<a href="#">188</a>
	Uses ID Decoder then Both Decoders	DIGENA2	<a href="#">188</a>
	*Uses Digimarc Decoder then Both Decoders	DIGENA3	<a href="#">188</a>
	Uses ID Decoder then Alternates Decoders	DIGENA4	<a href="#">188</a>
	Uses Digimarc Decoder then Alternates Decoders	DIGENA5	<a href="#">188</a>
Data Matrix	Default All Data Matrix Settings	IDMDFT	<a href="#">188</a>
	*On	IDMENA1	<a href="#">188</a>
	Off	IDMENA0	<a href="#">188</a>
Direct Part Marking (DPM) Decoding	Dotpeen DPM Decoding	DPMENA1	<a href="#">190</a>
	*Disable DPM Decoding	DPMENA0	<a href="#">190</a>
	Reflective (Etched) DPM Decoding	DPMENA2	<a href="#">190</a>
Data Matrix Msg. Length	Minimum (1-3116) *1	IDMMIN####	<a href="#">190</a>
	Maximum (1-3116) *3116	IDMMAX####	<a href="#">190</a>
Data Matrix Code Page	Data Matrix Code Page (*51)	IDMDCP##	<a href="#">190</a>
MaxiCode	Default All MaxiCode Settings	MAXDFT	<a href="#">191</a>
	On	MAXENA1	<a href="#">191</a>
	*Off	MAXENA0	<a href="#">191</a>
MaxiCode Msg. Length	Minimum (1-150) *1	MAXMIN###	<a href="#">191</a>
	Maximum (1-150) *150	MAXMAX###	<a href="#">191</a>

<b>Selection</b>	<b>Setting * Indicates default</b>	<b>Serial Command # Indicates a numeric entry</b>	<b>Page</b>
Aztec Code	Default All Aztec Code Settings	AZTDFT	192
	*On	AZTENA1	192
	Off	AZTENA0	192
Aztec Code Msg. Length	Minimum (1-3832) *1	AZTMIN####	192
	Maximum (1-3832) *3832	AZTMAX####	192
Aztec Append	*On	AZTAPP1	192
	Off	AZTAPP0	192
Aztec Code Page	Aztec Code Page (*51)	AZTDCP##	193
Chinese Sensible (Han Xin) Code	Default All Han Xin Code Settings	HX_DFT	193
	On	HX_ENA1	193
	*Off	HX_ENA0	193
Chinese Sensible (Han Xin) Code Msg. Length	Minimum (1-7833) *1	HX_MIN####	193
	Maximum (1-7833) *7833	HX_MAX####	193
<b>Postal Codes - 2D</b>			
2D Postal Codes	*Off	POSTAL0	194
Single 2D Postal Codes	Australian Post On	POSTAL1	194
	British Post On	POSTAL7	194
	Canadian Post On	POSTAL30	194
	Intelligent Mail Barcode On	POSTAL10	194
	Japanese Post On	POSTAL3	194
	KIX Post On	POSTAL4	194
	Planet Code On	POSTAL5	194
	Postal-4i On	POSTAL9	194
	Postnet On	POSTAL6	195
	Postnet with B and B' Fields On	POSTAL11	195
	InfoMail On	POSTAL2	195
Combination 2D Postal Codes	InfoMail and British Post On	POSTAL8	195
	Intelligent Mail Barcode and Postnet with B and B' Fields On	POSTAL20	195
	Postnet and Postal-4i On	POSTAL14	195
	Postnet and Intelligent Mail Barcode On	POSTAL16	195
	Postal-4i and Intelligent Mail Barcode On	POSTAL17	195
	Postal-4i and Postnet with B and B' Fields On	POSTAL19	195
	Planet and Postnet On	POSTAL12	196
	Planet and Postnet with B and B' Fields On	POSTAL18	196

<b>Selection</b>	<b>Setting * Indicates default</b>	<b>Serial Command # Indicates a numeric entry</b>	<b>Page</b>
	Planet and Postal-4i On	POSTAL13	<a href="#">196</a>
	Planet and Intelligent Mail Barcode On	POSTAL15	<a href="#">196</a>
	Planet, Postnet, and Postal-4i On	POSTAL21	<a href="#">196</a>
	Planet, Postnet, and Intelligent Mail Barcode On	POSTAL22	<a href="#">196</a>
	Planet, Postal-4i, and Intelligent Mail Barcode On	POSTAL23	<a href="#">196</a>
	Postnet, Postal-4i, and Intelligent Mail Barcode On	POSTAL24	<a href="#">196</a>
	Planet, Postal-4i, and Postnet with B and B' Fields On	POSTAL25	<a href="#">196</a>
	Planet, Intelligent Mail Barcode, and Postnet with B and B' Fields On	POSTAL26	<a href="#">196</a>
	Postal-4i, Intelligent Mail Barcode, and Postnet with B and B' Fields On	POSTAL27	<a href="#">197</a>
	Planet, Postal-4i, Intelligent Mail Barcode, and Postnet On	POSTAL28	<a href="#">197</a>
	Planet, Postal-4i, Intelligent Mail Barcode, and Postnet with B and B' Fields On	POSTAL29	<a href="#">196</a>
Planet Code Check Digit	Transmit	PLNCKX1	<a href="#">197</a>
	*Don't Transmit	PLNCKX0	<a href="#">197</a>
Postnet Check Digit	Transmit	NETCKX1	<a href="#">197</a>
	*Don't Transmit	NETCKX0	<a href="#">197</a>
Australian Post Interpretation	*Bar Output	AUSINT0	<a href="#">198</a>
	Numeric N Table	AUSINT1	<a href="#">198</a>
	Alphanumeric C Table	AUSINT2	<a href="#">198</a>
	Combination N and C Tables	AUSINT3	<a href="#">198</a>
<b>Postal Codes - Linear</b>			
China Post (Hong Kong 2 of 5)	Default All China Post (Hong Kong 2 of 5) Settings	CPCDFT	<a href="#">199</a>
	*Off	CPCENA0	<a href="#">199</a>
	On	CPCENA1	<a href="#">199</a>
China Post (Hong Kong 2 of 5) Msg. Length	Minimum (2 - 80) *4	CPCMIN##	<a href="#">199</a>
	Maximum (2 - 80) *80	CPCMAX##	<a href="#">199</a>
Korea Post	Default All Korea Post Settings	KPCDFT	<a href="#">199</a>
	*Off	KPCENA0	<a href="#">199</a>
	On	KPCENA1	<a href="#">199</a>

<b>Selection</b>	<b>Setting * Indicates default</b>	<b>Serial Command # Indicates a numeric entry</b>	<b>Page</b>
Korea Post Msg. Length	Minimum (2 - 80) *4	KPCMIN##	200
	Maximum (2 - 80) *48	KPCMAX##	200
Korea Post Check Digit	Transmit Check Digit	KPCCHK1	200
	*Don't Transmit Check Digit	KPCCHK0	200
<b>Imaging Default Commands</b>			
Image Snap	Default all Imaging Commands	IMGDFT	201
	Imaging Style - Decoding	SNPSTY0	202
	*Imaging Style - Photo	SNPSTY1	202
	Imaging Style - Manual	SNPSTY2	202
	Beeper On	SNPBEP1	202
	*Beeper Off	SNPBEP0	202
	*Wait for Trigger Off	SNPTRG0	203
	Wait for Trigger On	SNPTRG1	203
	*LED State - Off	SNPLED0	203
	LED State - On	SNPLED1	203
	Exposure (1-7874 microseconds) *7874	SNPEXP	203
	*Gain - None	SNPGAN1	204
	Gain - Medium	SNPGAN2	204
	Gain - Heavy	SNPGAN4	204
	Gain - Maximum	SNPGAN8	204
	Target White Value (0-255) *125	SNPWHT###	204
	Delta for Acceptance (0-255) *25	SNPDEL###	204
	Update Tries (0-10) *6	SNPTRY##	205
	Target Set Point Percentage (1-99) *50	SNPPCT##	205
Image Ship	*Infinity Filter - Off	IMGINFO	206
	Infinity Filter - On	IMGINF1	206
	*Compensation Off	IMGCOR0	206
	Compensation On	IMGCOR1	206
	*Pixel Depth - 8 bits/pixel (grayscale)	IMGBPP8	206
	Pixel Depth - 1 bit/pixel (B&W)	IMGBPP1	206
	*Don't Sharpen Edges	IMGEDG0	207
	Sharpen Edges (0-23)	IMGEDG##	207
	*File Format - JPEG	IMGFMT6	207
	File Format - KIM	IMGFMT0	207
	File Format - TIFF binary	IMGFMT1	207



<b>Selection</b>	<b>Setting * Indicates default</b>	<b>Serial Command # Indicates a numeric entry</b>	<b>Page</b>
	File Format - TIFF binary group 4, compressed	IMGFMT2	<a href="#">207</a>
	File Format - TIFF grayscale	IMGFMT3	<a href="#">207</a>
	File Format - Uncompressed binary	IMGFMT4	<a href="#">207</a>
	File Format - Uncompressed grayscale	IMGFMT5	<a href="#">207</a>
	File Format - BMP	IMGFMT8	<a href="#">207</a>
	*Histogram Stretch Off	IMGHIS0	<a href="#">208</a>
	Histogram Stretch On	IMGHIS1	<a href="#">208</a>
	*Noise Reduction Off	IMGFSP0	<a href="#">209</a>
	Noise Reduction On	IMGFSP1	<a href="#">209</a>
	Invert Image around X axis	IMGNVX1	<a href="#">208</a>
	Invert Image around Y axis	IMGNVY1	<a href="#">208</a>
	Rotate Image none	IMGROTO	<a href="#">209</a>
	Rotate Image 90° right	IMGROT1	<a href="#">209</a>
	Rotate Image 180° right	IMGROT2	<a href="#">209</a>
	Rotate Image 90° left	IMGROT3	<a href="#">209</a>
	JPEG Image Quality (0-100) *50	IMGJQF###	<a href="#">210</a>
	*Gamma Correction Off	IMGGAM0	<a href="#">210</a>
	Gamma Correction On (0-1000)	IMGGAM###	<a href="#">210</a>
	Image Crop - Left (0-843) *0	IMGWNL###	<a href="#">210</a>
	Image Crop - Right (0-843) *843	IMGWNR###	<a href="#">210</a>
	Image Crop - Top (0-639) *0	IMGWNT###	<a href="#">210</a>
	Image Crop - Bottom (0-639) *639	IMGWNB###	<a href="#">211</a>
	Image Crop - Margin (1-238) *0	IMGMAR###	<a href="#">211</a>
	Protocol - None (raw)	IMGXFR0	<a href="#">211</a>
	Protocol - None (default USB)	IMGXFR2	<a href="#">211</a>
	Protocol - Hmodem Compressed (default RS232)	IMGXFR3	<a href="#">211</a>
	Protocol - Hmodem	IMGXFR4	<a href="#">211</a>
	*Ship Every Pixel	IMGSUB1	<a href="#">212</a>
	Ship Every 2nd Pixel	IMGSUB2	<a href="#">212</a>
	Ship Every 3rd Pixel	IMGSUB3	<a href="#">212</a>
	*Document Image Filter Off	IMGUSH0	<a href="#">212</a>
	Document Image Filter On (0-255)	IMGUSH###	<a href="#">212</a>
	*Don't Ship Histogram	IMGHST0	<a href="#">213</a>

<b>Selection</b>	<b>Setting * Indicates default</b>	<b>Serial Command # Indicates a numeric entry</b>	<b>Page</b>
	Ship Histogram	IMGHST1	<a href="#">213</a>
Image Size Compatibility	Force VGA Resolution	IMGVGA1	<a href="#">213</a>
	*Native Resolution	IMGVGA0	<a href="#">214</a>
Intelligent Signature Capture	Optimize On	DECBND1	<a href="#">214</a>
	*Optimize Off	DECBND0	<a href="#">214</a>
<b>Utilities</b>			
Add Code I.D. Prefix to All Symbologies (Temporary)		PRECA2,BK2995C80!	<a href="#">221</a>
Show Software Revision		REVINF	<a href="#">221</a>
Test Menu	On	TSTMNU1	<a href="#">222</a>
	*Off	TSTMNU0	<a href="#">222</a>
Application Plug-Ins (Apps)	*Decoding Apps On	PLGDCE1	<a href="#">222</a>
	Decoding Apps Off	PLGDCE0	<a href="#">222</a>
	*Formatting Apps On	PLGFOE1	<a href="#">222</a>
	Formatting Apps Off	PLGFOE0	<a href="#">222</a>
	List Apps	PLGINF	<a href="#">222</a>
Reset the Factory Defaults	Remove Custom Defaults	DEFOVR	<a href="#">224</a>
	Activate Defaults	DEFALT	<a href="#">224</a>

## Granit XP SR and Granit XP XR 1990i Corded Scanner Product Specifications

Parameter	Specification
<b>Mechanical</b>	
Height	7.5 inches (192mm)
Length	3.9 inches (100mm)
Width	2.9 inches (76mm)
Weight	11.2 ounces (320g)
<b>Electrical</b>	
Voltage Requirements	4.4 to 5.5 VDC at input connector
Current Draw	ScanningStandby 500mA @ 5VDC, 2.5W
Illumination LED: Peak Wavelength	625nm (red LED) IEC 62471: "Exempt Risk Group"
Aiming: Peak Wavelength Laser	655nm class1 laser product (SR scanner) 655nm class 2 laser product (XR scanner) complies IEC 60825 Ed3
<b>Environmental</b>	
Temperature Ranges: Operating	-22°F to 122°F (-30°C to 50°C) -40°F to 158°F (-40°C to 70°C)
Storage	-40°F to 158°F (-40°C to 70°C)
Humidity	0 to 95% non-condensing
Mechanical Drop	2 m (6.5 ft): 50 drops from -30°C to 50°C (-22°F to 122°F), uncontrolled RH 2.4 m (8 ft): 20 drops at 25°C (77°F), 55% RH 3 m (10 ft): MIL-STD-810G, 25°C (77°F), 55% RH

Parameter (Continued)	Specification
ESD Tolerance	Up to ±20kV direct air Up to 8 kV indirect coupling plane
<b>Image</b>	
Image Size	1280 x 800 pixels
<b>Scan Performance</b>	
Skew Angle	±65°
Pitch Angle 1D barcode 2D barcode	1D code: ±65° 2D code: ±45°
Motion Tolerance	Up to 4.5 m/s (157 in/s) for 13 mil UPC at optimal focus
Symbol Contrast	20% or greater (Grade A)
<b>Field of View</b>	
XP SR	48°H 30°V
XP XR	Near 48°H 30°V Far 19°H 11.9°V

## Granit XP SR and Granit XP XR 1991i Cordless Scanner Product Specifications

Parameter	Specification
<b>Mechanical</b>	
Height	7.5 inches (192mm)
Length	3.9 inches (100mm)
Width	2.9 inches (76mm)
Weight	14.2 ounces (405g)
<b>Electrical</b>	
Current Draw	Operating Power (Charging) 500mA @ 5VDC, 2.5W
Illumination LED: Peak Wavelength	625nm (red LED) IEC 62471: "Exempt Risk Group"
Aiming: Peak Wavelength Laser	655nm class1 laser product (SR scanner) 655nm class 2 laser product (XR scanner) complies IEC 60825 Ed3
<b>Battery</b>	
Lithium Ion Number of Scans Expected Hours of Operation Expected Charge Time	2450 mAh minimum Up to 50,000 per charge 14 4.5 hours

Parameter (Continued)	Specification
<b>Radio</b>	
Frequency	2.4 to 2.5 GHz (ISM Band) Frequency Hopping Bluetooth v 4.2
Range	33 ft. (10 m) typical
<b>Environmental</b>	
Temperature Ranges: Operating Storage with battery*	-4° F to +122° F (-20° C to 50° C) -4 F to +95 F (-20 C to 35 C) for storage up to 90 days -4 F to +68 F (-20 C to 20 C) for storage up to 365 days
Storage without battery	-40°F to +158°F (-40°C to 70°C)
Humidity	Up to 95% non-condensing
Mechanical Drop	2 m (6.5 ft): 50 drops from -30°C to 50°C (-22°F to 122°F), uncontrolled RH 2.4 m (8 ft): 20 drops at 25°C (77°F), 55% RH 3 m (10 ft): MIL-STD-810G, 25°C (77°F), 55% RH
ESD Sensitivity	Up to ±20kV direct air Up to ±8 kV indirect coupling
<b>Image</b>	
Image Size	1280 x 800 pixels
<b>Scan Performance</b>	
Skew Angle	±65°
Pitch Angle 1D barcode 2D barcode	1D barcodes: ±65° 2D barcodes: ±45°
Motion Tolerance	Up to 4.5 m/s (157 in/s) for 13 mil UPC at optimal focus
Symbol Contrast	20% or greater (Grade A)
<b>Field of View</b>	
XP SR	48°H 30°V
XP XR	Near 48°H 30°V Far 19°H 11.9°V

\*Storage outside of this temperature range could be detrimental to battery life.

# CCB22-100BT-03N/COB22 Charge Base Product Specifications

Parameter	Specification
<b>Mechanical</b>	
Height	2.3 inches (60 mm)
Length	9.6 inches (245 mm)
Width	4.0 inches (102 mm)
Weight	
CCB22	10.4 oz (295g)
COB22	10.2 oz (290g)
<b>Electrical</b>	
Voltage:	4.0 to 5.5 VDC
Current Draw:	
Host Terminal Port	500mA
Aux Power Port	1A
Charge Time	5 hours
<b>Radio</b>	
Frequency	2.4 to 2.5 GHz (ISM Band) Frequency Hopping Bluetooth v.2.1
Range	330 ft. (100 m) typical
Data Rate	Up to 1 MBps
<b>Environmental</b>	
Temperature Ranges:	
Operating	-4° F to +122° F (-20° C to +50° C)
Storage	-40° F to +158° F (-40° C to +70° C)
Humidity	Up to 95% non-condensing
Mechanical Drop	Operational after 50 drops from 3.28 feet (1 m) to concrete
Vibration	5G Peak from 22Hz to 300Hz
ESD Sensitivity	Up to ±20kV direct air Up to ±8 kV indirect coupling plane

# Depth of Field Charts

## Granit XP SR Performance

Focus		Typical Spec			Guaranteed Spec		
3 mil Code 39	mm	39	104	65	49	91	42
	in.	1.53	4.09	2.55	1.92	3.58	1.65
5 mil Code 39	mm	20	220	200	26	197	171
	in.	0.78	8.66	7.87	1.02	7.75	6.73
10mil Code 39	mm	0	490	490	10	451	441
	in.	0	19.29	19.29	0.39	17.75	17.36
13 mil UPC	mm	0	504	504	10	464	454
	in.	0	19.84	19.84	0.39	18.26	17.87
15 mil C128	mm	0	628	628	10	564	554
	in.	0	24.72	24.72	0.39	22.20	21.81
20 mil Code 39	mm	0	837	837	10	700	690
	in.	0	32.95	32.95	0.39	27.55	27.16
5 mil PDF147	mm	35	146	111	42	137	95
	in.	1.37	5.74	4.37	1.65	5.39	3.74
6.7 mil PDF417	mm	20	209	189	26	194	168
	in.	0.78	8.22	7.44	1.02	7.63	6.61
7.5 mil DM	mm	50	156	106	65	142	77
	in.	1.96	6.14	4.17	2.55	5.59	3.03
10 mil Data Matrix	mm	30	220	190	41	188	147
	in.	1.18	8.66	7.48	1.61	7.40	5.78
15 mil QR Code	mm	0	352	352	10	315	305
	in.	0	13.85	13.85	0.39	12.40	12.00
20 mil QR Code	mm	33	475	442	0	447	17.6
	in.	1.3	18.7	17.4	0	447	17.6

# Granit XP XR Performance

Focus		Typical Spec			Guaranteed Spec		
3 mil Code 39	mm	39	104	65	49	91	42
	in.	1.53	4.09	2.55	1.92	3.58	1.65
5 mil Code 39	mm	20	220	200	26	197	171
	in.	0.78	8.66	7.87	1.02	7.75	6.73
10mil Code 39	mm	0	1215	1215	10	1022	1425
	in.	0	47.83	47.83	0.39	40.23	56.10
10.4 mil C128	mm	3	343	341	10	310	300
	in.	0.1	13.5	13.4	0.4	12.2	11.8
13 mil UPCA	mm	0	1520	1520	10	1435	1425
	in.	0	59.84	59.84	0.39	56.49	56.10
15 mil C128	mm	0	1727	1727	10	1446	1436
	in.	0	67.99	67.99	0.39	57.71	56.53
20 mil Code 39	mm	0	2236	2236	10	1840	1830
	in.	0	88.03	88.03	0.39	72.44	72.04
20 mil QR Code	mm	0	484	484	0	447	17.6
	in.	0	19.1	19.1	0	447	17.6
22 mil QR Code	mm	0	1671	1671	10	1564	1554
	in.	0	65.8	65.8	0.4	61.6	61.2
5 mil PDF147	mm	35	146	111	42	137	95
	in.	1.37	5.74	4.37	1.65	5.39	3.74
6.7 mil PDF417	mm	20	209	189	26	194	168
	in.	0.78	8.22	7.44	1.02	7.63	6.61
7.5 mil DM	mm	50	156	106	65	142	77
	in.	1.96	6.14	4.17	2.55	5.59	3.03
10 mil Data Matrix	mm	30	220	190	41	188	147
	in.	1.18	8.66	7.48	1.61	7.40	5.78
15 mil QR Code	mm	0	352	352	10	315	305
	in.	0	13.85	13.85	0.39	12.40	12.00
55 mil C39	mm	86	6600	6514	94	5460	5366
	in.	3.38	259.84	256.45	3.70	214.96	211.25
70 mil C128	mm	136	7540	7404	145	6312	6167
	in.	5.4	285	279.6	5.7	248.5	242.8
100 Mil C39	mm	280	10650	10370	288	8820	8532
	in.	11.02	419.29	408.26	11.33	347.24	335.90
100 mil C39 Retro	mm	172	9460	9288	190	8060	7870
	in.	6.77	372.44	365.66	7.48	317.32	309.84
100 mil DM	mm	156	5610	5454	170	4360	4190
	in.	6.14	220.86	214.72	6.69	171.65	164.96





# Standard Connector Pinouts

**Note:** The following pin assignments are not compatible with some Honeywell legacy products. Use of a cable with improper pin assignments may lead to damage to the unit. Use of any cables not provided by the manufacturer may result in damage not covered by your warranty.

## Keyboard Wedge

10 Pin RJ41 Modular Plug - connects to the base

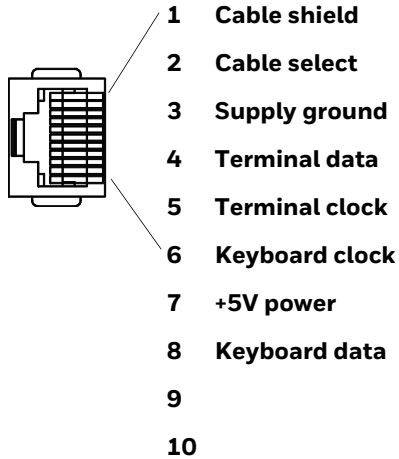

## Serial Output

10 Pin RJ41 Modular Plug - connects to the base

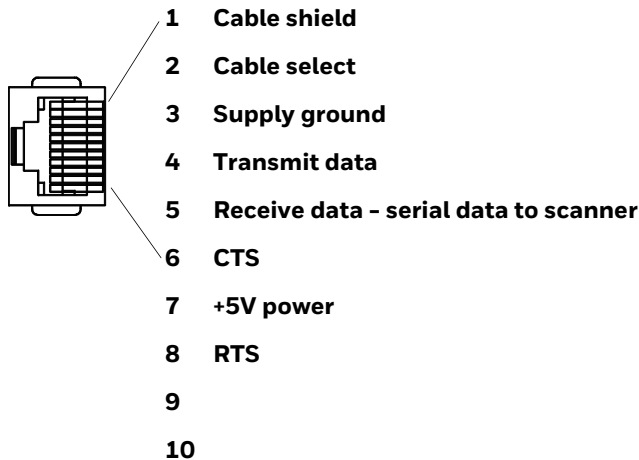

# RS485 Output

10 Pin RJ41 Modular Plug - connects to the base

**Note:** RS485 signal conversion is performed in the cable.

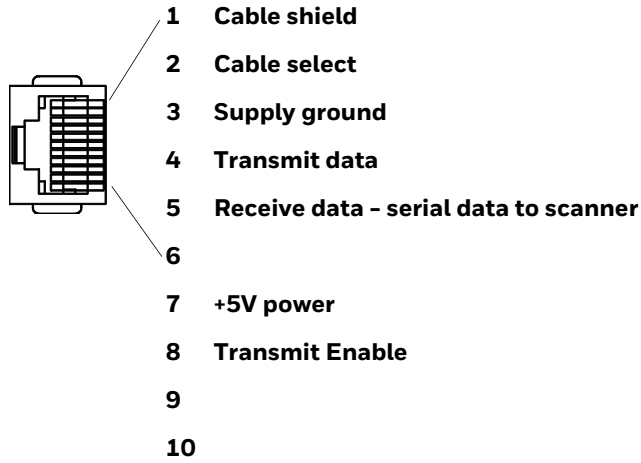

# USB

10 Pin Modular Plug - connects to the base

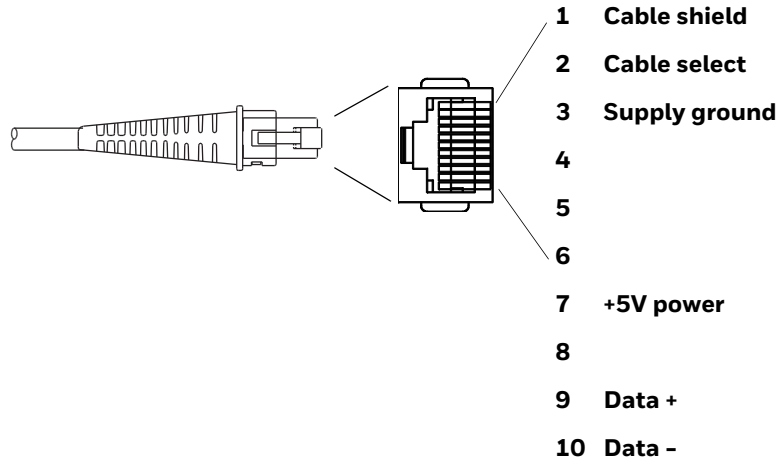

# Required Safety Labels

## Scanner

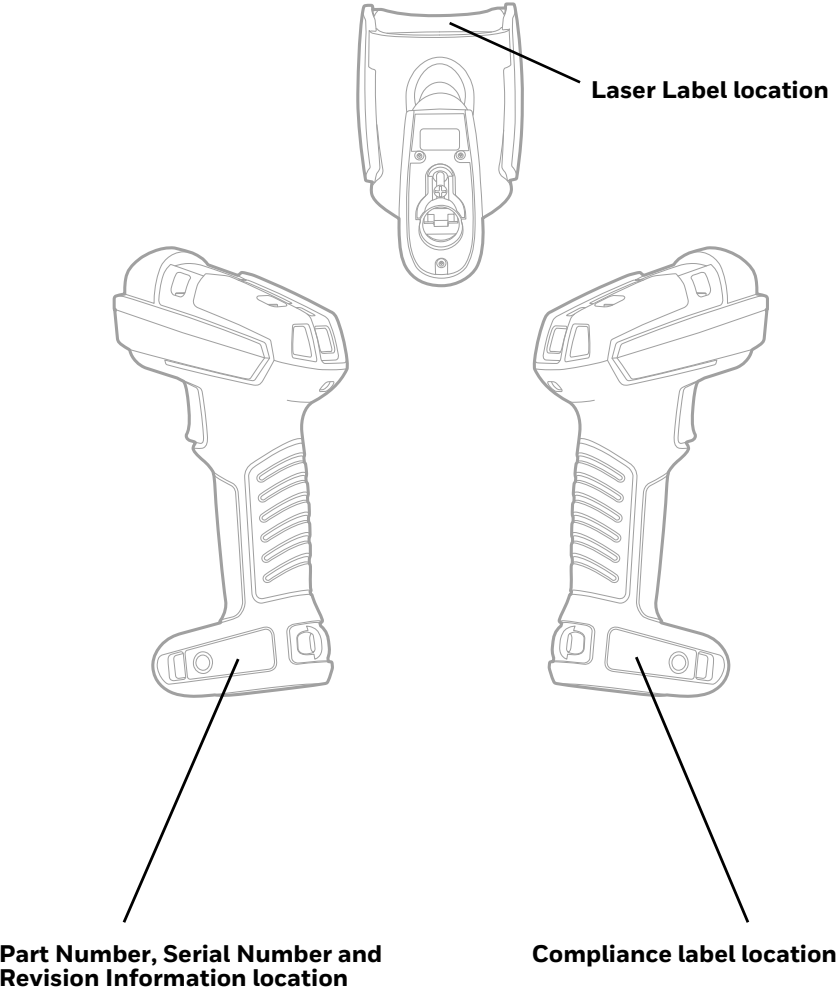

## CCB22-100BT-03N-BF Base

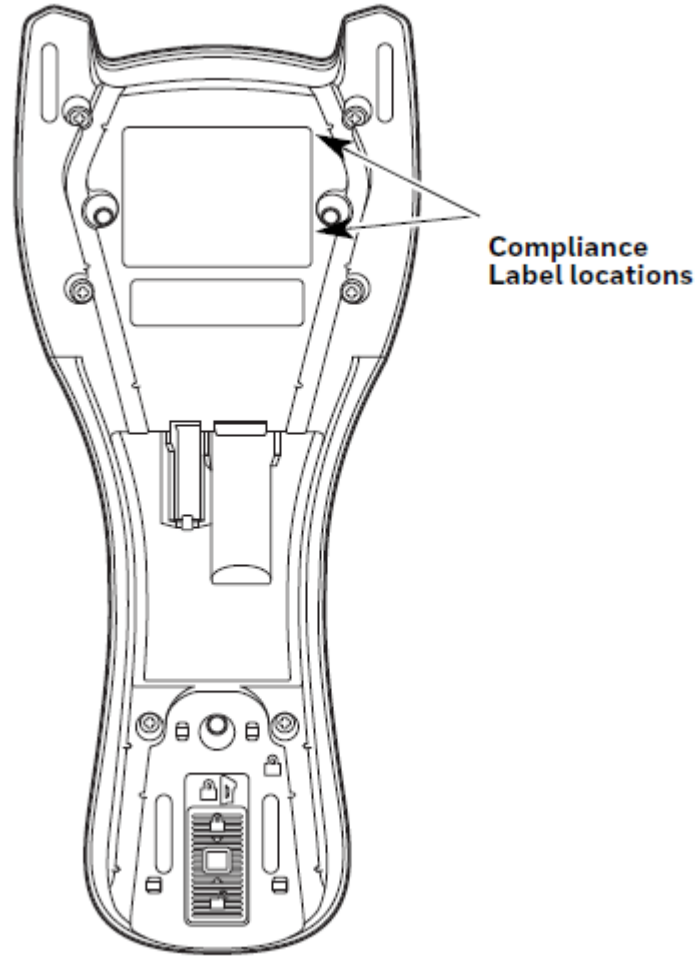



# MAINTENANCE AND TROUBLESHOOTING

## Repairs

Repairs and/or upgrades are not to be performed on this product. These services are to be performed only by an authorized service center (see [Customer Support](#) on page xiii).

## Maintenance

Your device provides reliable and efficient operation with a minimum of care. Although specific maintenance is not required, the following sections describe periodic checks to ensure dependable operation.

## Clean the Scanner

The scanner or base's housing may be cleaned with a soft cloth dampened with water or a mild detergent-water solution. If a mild detergent solution is used, wipe the scanner or base with a clean cloth dampened only with water to remove any detergent residue.

You can use either Dimension 256 or ethyl alcohol to clean the device.



**Caution:** Do not submerge the scanner in water. Do not use abrasive wipes or cloths on the scanner's window. Abrasive wipes may scratch the window. Never use solvents (e.g., acetone) on the housing or window. Solvents may damage the finish or the window.

**Caution:** Ensure all components are dry prior to mating the scanner with charging accessories or other peripheral devices. Mating wet components may cause damage not covered by the warranty.

## Clean the Window

Reading performance may degrade if the scanner's window is not clean. If the window is visibly dirty, or if the scanner isn't operating well, clean the window with soft cloth dampened with water.



**Caution: Do not use abrasive wipes or cloths on the scanner's window. Abrasive wipes may scratch the window. Never use solvents (e.g., acetone) on the window. Solvents may damage the window.**

## Inspect Cords and Connectors

Inspect the interface cable and connector for wear or other signs of damage. A badly worn cable or damaged connector may interfere with scanner operation. Contact your distributor for information about cable replacement and see [Replace Cables in Corded Scanners](#) on page 272.

## Replace Cables in Corded Scanners

The standard interface cable is attached to the scanner with an 10-pin modular connector. When properly seated, the connector is held in place with a screw and locking plate. The interface cable is designed to be field replaceable.

- Order replacement cables from Honeywell or from an authorized distributor.
- When ordering a replacement cable, specify the cable part number of the original interface cable.

## Replace an Interface Cable

1. Turn off the power to the host system.
2. Disconnect the scanner's cable from the terminal or computer.
3. Locate the small screw at the bottom of the locking plate.
4. Loosen the screw.
5. Loosen the locking plate and slide it over the base of the cable connector to remove the cable from the device.
6. Remove the O-ring from the end of the cable connection.
7. See [Connect a Corded Device](#), to connect the new cord to the scanner.



# Replace Cables and Batteries in Cordless Systems

## Replace an Interface Cable in a Base

1. Turn the power to the host system OFF.
2. Disconnect the base's cable from the terminal or computer.
3. Turn the base upside down.
4. Pull the connector out while maintaining pressure on the connector release clip.
5. Replace with the new cable. Insert the connector into the opening and press firmly. The connector is keyed to go in only one way, and will click into place.

## Change a Scanner Battery

1. Rotate metal twist at bottom of battery door counterclockwise.
2. Remove battery.
3. Insert replacement battery.
4. Replace end cap and screw together.

## Troubleshoot a Corded Scanner

The scanner automatically performs self-tests whenever you turn it on. If your scanner is not functioning properly, review the following Troubleshooting Guide to try to isolate the problem.

### ***Is the power on? Is the aimer on?***

If the aimer isn't illuminated, check that:

- The cable is connected properly.
- The host system power is on (if external power isn't used).
- The trigger works.

### ***Is the scanner having trouble reading your symbols?***

If the scanner isn't reading symbols well, check that the symbols:

- Aren't smeared, rough, scratched, or exhibiting voids.
- Aren't coated with frost or water droplets on the surface.
- Are enabled in the scanner or in the decoder to which the scanner connects.

### ***Is the barcode displayed but not entered?***

The barcode is displayed on the host device correctly, but you still have to press a key to enter it (the Enter/Return key or the Tab key, for example).

- You need to program a suffix. Programming a suffix enables the scanner to output the barcode data plus the key you need (such as “CR”) to enter the data into your application. Refer to [Prefix/Suffix Overview](#) on page 113 for further information.

If you aren’t sure what programming options have been set in the scanner, or if you want the factory default settings restored, refer to [Reset the Factory Defaults](#) on page 224.

## Troubleshoot a Cordless System

### Troubleshoot a Base

**Note:** Visit the Services and Support section of our website ([www.honeywellaidc.com](http://www.honeywellaidc.com)) to check for the latest software for both the scanner and the base.

If your base is not functioning properly, review the following troubleshooting guidelines to try to isolate the problem.

#### ***Is the red LED on?***

If the red LED isn’t illuminated, check that:

- The power cable is connected properly and there is power at the power source.
- The host system power is on (if external power isn’t used).

#### ***Is the green LED on?***

If the green LED isn’t illuminated, check that:

- The scanner is correctly placed in the base.
- There is external power or 12 volt host power.
- Charge mode is turned on. (See ["Beeper and LED Sequences and Meaning" on page 45](#))
- The battery is not bad or deeply discharged. In some cases, the scanner’s battery may trickle charge to bring it into an acceptable level and then transition to a normal charge cycle.

### Troubleshoot a Cordless Scanner

**Note:** Make sure that your scanner’s battery is charged. Visit the Services and Support section of our website ([www.honeywellaidc.com](http://www.honeywellaidc.com)) to check for the latest software for both the scanner and the base or Access Point.

***Is the scanner having trouble reading your symbols?***

If the scanner isn't reading symbols well, check that the symbols:

- Aren't smeared, rough, scratched, or exhibiting voids.
- Aren't coated with frost or water droplets on the surface.
- Are enabled in the base or Access Point to which the scanner connects.

***Is the barcode displayed but not entered into the application?***

The barcode is displayed on the host device correctly, but you still have to press a key to enter it (the Enter/Return key or the Tab key, for example).

- You need to program a suffix. Programming a suffix enables the scanner to output the barcode data plus the key you need (such as "CR") to enter the data into your application. Refer to [Prefix/Suffix Overview](#) on page 113 for further information.

***The scanner won't read your barcode at all.***

- Scan the sample barcodes in the back of this manual. If the scanner reads the sample barcodes, check that your barcode is readable.
- Verify that your barcode symbology is enabled (see [Chapter 7](#)).



## REFERENCE CHARTS

## Symbology Charts

**Note:** “m” represents the AIM modifier character. Refer to *International Technical Specification, Symbology Identifiers*, for AIM modifier character details.

Prefix/Suffix entries for specific symbologies override the universal (All Symbologies, 99) entry.

Refer to [Data Edit](#) beginning on page 113 and [Data Format](#) beginning on page 119 for information about using Code ID and AIM ID.

## Linear Symbologies

Linear Symbology	AIM		Honeywell	
	ID	Possible modifiers (m)	ID	Hex
All Symbologies				99
Codabar	JFm	0-1	a	61
Code 11	JH3		h	68
Code 128	JCm	0, 1, 2, 4	j	6A
Code 32 Pharmaceutical (PARAF)	JX0		<	3C
Code 39 (supports Full ASCII mode)	JAm	0, 1, 3, 4, 5, 7	b	62
TCIF Linked Code 39 (TLC39)	JL2		T	54
Code 93 and 93i	JGm	0-9, A-Z, a-m	i	69
EAN	JEm	0, 1, 3, 4	d	64
EAN-13 (including Bookland EAN)	JE0		d	64
EAN-13 with Add-On	JE3		d	64
EAN-13 with Extended Coupon Code	JE3		d	64
EAN-8	JE4		D	44

Linear Symbology	AIM		Honeywell	
	ID	Possible modifiers (m)	ID	Hex
EAN-8 with Add-On	JE3		D	44
GS1				
GS1 DataBar	Jem	0	y	79
GS1 DataBar Limited	Jem		{	7B
GS1 DataBar Expanded	Jem		}	7D
GS1-128	JC1		l	49
2 of 5				
China Post (Hong Kong 2 of 5)	JX0		Q	51
Interleaved 2 of 5	Jlm	0, 1, 3	e	65
Matrix 2 of 5	JX0		m	6D
NEC 2 of 5	JX0		Y	59
Straight 2 of 5 IATA	JRm	0, 1, 3	f	66
Straight 2 of 5 Industrial	JS0		f	66
MSI	JMm	0, 1	g	67
Telepen	JBm		t	74
UPC		0, 1, 2, 3, 8, 9, A, B, C		
UPC-A	JE0		c	63
UPC-A with Add-On	JE3		c	63
UPC-A with Extended Coupon Code	JE3		c	63
UPC-E	JE0		E	45
UPC-E with Add-On	JE3		E	45
UPC-E1	JX0		E	45

Add Honeywell Code ID				5C80
Add AIM Code ID				5C81
Add Backslash				5C5C
Batch mode quantity			5	35

## 2D Symbologies

2D Symbology	AIM		Honeywell	
	ID	Possible modifiers (m)	ID	Hex
All Symbologies				99
Aztec Code	lzm	0-9, A-C	z	7A
Chinese Sensible Code (Han Xin Code)	lX0		H	48
Codablock A	lO6	0, 1, 4, 5, 6	V	56
Codablock F	lOm	0, 1, 4, 5, 6	q	71
Data Matrix	ldm	0-6	w	77
Dot Code	lJO		.	2E
GS1	lem	0-3	y	79
GS1 Composite	lem	0-3	y	79
GS1 DataBar Omnidirectional	lem	0-3	y	79
MaxiCode	lUm	0-3	x	78
PDF417	lLm	0-2	r	72
MicroPDF417	lLm	0-5	R	52
QR Code	lQm	0-6	s	73
Micro QR Code	lQm		s	73

## Postal Symbologies

Postal Symbology	AIM		Honeywell	
	ID	Possible modifiers (m)	ID	Hex
All Symbologies				99
Australian Post	lX0		A	41
British Post	lX0		B	42
Canadian Post	lX0		C	43
China Post	lX0		Q	51
InfoMail	lX0		,	2c
Intelligent Mail Barcode	lX0		M	4D
Japanese Post	lX0		J	4A
KIX (Netherlands) Post	lX0		K	4B
Korea Post	lX0		?	3F
Planet Code	lX0		L	4C
Postal-4i	lX0		N	4E
Postnet	lX0		P	50

# ASCII Conversion Chart (Code Page 1252)

In keyboard applications, ASCII Control Characters can be represented in 3 different ways, as shown below. The CTRL+X function is OS and application dependent. The following table lists some commonly used Microsoft functionality. This table applies to U.S. style keyboards. Certain characters may differ depending on your Country Code/PC regional settings.

Non-printable ASCII control characters			Keyboard Control + ASCII (CTRL+X) Mode		
DEC	HEX	Char	Control + X Mode Off (KBDCAS0)	Windows Mode Control + X Mode On (KBDCAS2)	
				CTRL + X	CTRL + X function
0	00	NUL	Reserved	CTRL+ @	
1	01	SOH	NP Enter	CTRL+ A	Select all
2	02	STX	Caps Lock	CTRL+ B	Bold
3	03	ETX	ALT Make	CTRL+ C	Copy
4	04	EOT	ALT Break	CTRL+ D	Bookmark
5	05	ENQ	CTRL Make	CTRL+ E	Center
6	06	ACK	CTRL Break	CTRL+ F	Find
7	07	BEL	Enter / Ret	CTRL+ G	
8	08	BS	<i>(Apple Make)</i>	CTRL+ H	History
9	09	HT	Tab	CTRL+ I	Italic
10	0A	LF	<i>(Apple Break)</i>	CTRL+ J	Justify
11	0B	VT	Tab	CTRL+ K	hyperlink
12	0C	FF	Delete	CTRL+ L	list, left align
13	0D	CR	Enter / Ret	CTRL+ M	
14	0E	SO	Insert	CTRL+ N	New
15	0F	SI	ESC	CTRL+ O	Open
16	10	DLE	F11	CTRL+ P	Print
17	11	DC1	Home	CTRL+ Q	Quit
18	12	DC2	PrtScn	CTRL+ R	
19	13	DC3	Backspace	CTRL+ S	Save
20	14	DC4	Back Tab	CTRL+ T	
21	15	NAK	F12	CTRL+ U	
22	16	SYN	F1	CTRL+ V	Paste
23	17	ETB	F2	CTRL+ W	
24	18	CAN	F3	CTRL+ X	
25	19	EM	F4	CTRL+ Y	?
26	1A	SUB	F5	CTRL+ Z	?
27	1B	ESC	F6	CTRL+ [	?
28	1C	FS	F7	CTRL+ \	?
29	1D	GS	F8	CTRL+ ]	?
30	1E	RS	F9	CTRL+ ^	?
31	1F	US	F10	CTRL+ -	?
127	7F	△	NP Enter		?



# Lower ASCII Reference Table

**Note:** Windows Code page 1252 and lower ASCII use the same characters.

Printable Characters								
DEC	HEX	Character	DEC	HEX	Character	DEC	HEX	Character
32	20	<SPACE>	64	40	@	96	60	`
33	21	!	65	41	A	97	61	a
34	22	"	66	42	B	98	62	b
35	23	#	67	43	C	99	63	c
36	24	\$	68	44	D	100	64	d
37	25	%	69	45	E	101	65	e
38	26	&	70	46	F	102	66	f
39	27	'	71	47	G	103	67	g
40	28	(	72	48	H	104	68	h
41	29	)	73	49	I	105	69	i
42	2A	*	74	4A	J	106	6A	j
43	2B	+	75	4B	K	107	6B	k
44	2C	,	76	4C	L	108	6C	l
45	2D	-	77	4D	M	109	6D	m
46	2E	.	78	4E	N	110	6E	n
47	2F	/	79	4F	O	111	6F	o
48	30	0	80	50	P	112	70	p
49	31	1	81	51	Q	113	71	q
50	32	2	82	52	R	114	72	r
51	33	3	83	53	S	115	73	s
52	34	4	84	54	T	116	74	t
53	35	5	85	55	U	117	75	u
54	36	6	86	56	V	118	76	v
55	37	7	87	57	W	119	77	w
56	38	8	88	58	X	120	78	x
57	39	9	89	59	Y	121	79	y
58	3A	:	90	5A	Z	122	7A	z
59	3B	;	91	5B	[	123	7B	{
60	3C	<	92	5C	\	124	7C	
61	3D	=	93	5D	]	125	7D	}
62	3E	>	94	5E	^	126	7E	~
63	3F	?	95	5F	_	127	7F	△

Extended ASCII Characters					
DEC	HEX	CP 1252	ASCII	Alternate Extended	PS2 Scan Code
128	80	€	Ç	up arrow ↑	0x48
129	81		ü	down arrow ↓	0x50
130	82	,	é	right arrow →	0x4B
131	83	f	â	left arrow ←	0x4D
132	84	„	ä	Insert	0x52
133	85	…	à	Delete	0x53
134	86	†	å	Home	0x47
135	87	‡	ç	End	0x4F
136	88	^	ê	Page Up	0x49
137	89	‰	ë	Page Down	0x51
138	8A	Š	è	Right ALT	0x38
139	8B	<	ï	Right CTRL	0x1D

**Extended ASCII Characters (Continued)**

DEC	HEX	CP 1252	ASCII	Alternate Extended	PS2 Scan Code
140	8C	Œ	î	Reserved	n/a
141	8D		ï	Reserved	n/a
142	8E	Ž	Ā	Numeric Keypad Enter	0x1C
143	8F		Ă	Numeric Keypad /	0x35
144	90		É	F1	0x3B
145	91	‘	æ	F2	0x3C
146	92	’	Æ	F3	0x3D
147	93	“	ô	F4	0x3E
148	94	”	ö	F5	0x3F
149	95	•	ò	F6	0x40
150	96	–	û	F7	0x41
151	97	—	ù	F8	0x42
152	98	˜	ÿ	F9	0x43
153	99	™	Ö	F10	0x44
154	9A	š	Ü	F11	0x57
155	9B	›	ç	F12	0x58
156	9C	œ	£	Numeric Keypad +	0x4E
157	9D		¥	Numeric Keypad -	0x4A
158	9E	ž	Ps	Numeric Keypad *	0x37
159	9F	ÿ	f	Caps Lock	0x3A
160	A0		á	Num Lock	0x45
161	A1	ı	í	Left Alt	0x38
162	A2	ç	ó	Left Ctrl	0x1D
163	A3	£	ú	Left Shift	0x2A
164	A4	¤	ñ	Right Shift	0x36
165	A5	¥	Ñ	Print Screen	n/a
166	A6	ı	ª	Tab	0x0F
167	A7	§	º	Shift Tab	0x8F
168	A8	¨	¿	Enter	0x1C
169	A9	©	ƒ	Esc	0x01
170	AA	ª	¬	Alt Make	0x36
171	AB	«	½	Alt Break	0xB6
172	AC	¬	¼	Control Make	0x1D
173	AD		ı	Control Break	0x9D
174	AE	®	«	Alt Sequence with 1 Character	0x36
175	AF	™	»	Ctrl Sequence with 1 Character	0x1D
176	B0	°	␣		
177	B1	±	␣		
178	B2	²	␣		
179	B3	³	␣		
180	B4	´	␣		
181	B5	µ	␣		
182	B6	¶	␣		
183	B7	·	␣		
184	B8	¸	␣		
185	B9	¹	␣		
186	BA	º	␣		
187	BB	»	␣		
188	BC	¼	␣		
189	BD	½	␣		
190	BE	¾	␣		
191	BF	¿	␣		
192	C0	À	L		
193	C1	Á	⌞		

Extended ASCII Characters (Continued)					
DEC	HEX	CP 1252	ASCII	Alternate Extended	PS2 Scan Code
194	C2	Â	T		
195	C3	Ã	†		
196	C4	Ä	—		
197	C5	Å	í		
198	C6	Æ	‡		
199	C7	Ç	‡		
200	C8	È	‡		
201	C9	É	‡		
202	CA	Ê	‡		
203	CB	Ë	‡		
204	CC	Ì	‡		
205	CD	Í	=		
206	CE	Î	‡		
207	CF	Ï	‡		
208	D0	Ð	‡		
209	D1	Ñ	‡		
210	D2	Ò	‡		
211	D3	Ó	‡		
212	D4	Ô	‡		
213	D5	Õ	F		
214	D6	Ö	‡		
215	D7	×	‡		
216	D8	Ø	‡		
217	D9	Ù	J		
218	DA	Ú	‡		
219	DB	Û	■		
220	DC	Ü	■		
221	DD	Ý	■		
222	DE	Þ	■		
223	DF	ß	■		
224	E0	à	α		
225	E1	á	β		
226	E2	â	Γ		
227	E3	ã	π		
228	E4	ä	Σ		
229	E5	å	σ		
230	E6	æ	μ		
231	E7	ç	τ		
232	E8	è	Φ		
233	E9	é	Θ		
234	EA	ê	Ω		
235	EB	ë	δ		
236	EC	ì	∞		
237	ED	í	φ		
238	EE	î	ε		
239	EF	ï	∩		
240	F0	ð	≡		
241	F1	ñ	±		
242	F2	ò	≥		
243	F3	ó	≤		
244	F4	ô			
245	F5	õ	]		
246	F6	ö	+		
247	F7	÷	≈		

Extended ASCII Characters (Continued)					
DEC	HEX	CP 1252	ASCII	Alternate Extended	PS2 Scan Code
248	F8	ø	°		
249	F9	ù	·		
250	FA	ú	·		
251	FB	û	√		
252	FC	ü	n		
253	FD	ý	²		
254	FE	þ	■		
255	FF	ÿ			

## ISO 2022/ISO 646 Character Replacements

Code pages define the mapping of character codes to characters. If the data received does not display with the proper characters, it may be because the barcode being scanned was created using a code page that is different from the one the host program is expecting. If this is the case, select the code page with which the barcodes were created. The data characters should then appear properly.

Code Page Selection Method/ Country	Standard	Keyboard Country	Honeywell Code Page Option
United States (standard ASCII)	ISO/IEC 646-IRV	n/a	1
Automatic National Character Replacement	ISO/IEC 2022	n/a	2 (default)
Binary Code page	n/a	n/a	3
<b>Default "Automatic National Character replacement" will select the below Honeywell Code Page options for Code128, Code 39 and Code 93.</b>			
United States	ISO/IEC 646-06	0	1
Canada	ISO /IEC 646-121	54	95
Canada	ISO /IEC 646-122	18	96
Japan	ISO/IEC 646-14	28	98
China	ISO/IEC 646-57	92	99
Great Britain (UK)	ISO /IEC 646-04	7	87
France	ISO /IEC 646-69	3	83
Germany	ISO/IEC646-21	4	84
Switzerland	ISO /IEC 646-CH	6	86
Sweden / Finland (extended Annex C)	ISO/IEC 646-11	2	82
Ireland	ISO /IEC 646-207	73	97
Denmark	ISO/IEC 646-08	8	88
Norway	ISO/IEC 646-60	9	94
Italy	ISO/IEC 646-15	5	85
Portugal	ISO/IEC 646-16	13	92
Spain	ISO/IEC 646-17	10	90
Spain	ISO/IEC 646-85	51	91

Dec			35	36	64	91	92	93	94	96	123	124	125	126
Hex			23	24	40	5B	5C	5D	5E	60	7B	7C	7D	7E
US	0	1	#	\$	@	[	\	]	^	`	{		}	~
CA	54	95	#	\$	à	â	ç	ê	î	ô	é	ù	è	û
CA	18	96	#	\$	à	â	ç	ê	É	ô	é	ù	è	û
JP	28	98	#	\$	@	[	¥	]	^	`	{		}	-
CN	92	99	#	¥	@	[	\	]	^	`	{		}	-
GB	7	87	£	\$	@	[	\	]	^	`	{		}	~
FR	3	83	£	\$	à	°	ç	§	^	μ	é	ù	è	¨
DE	4	84	#	\$	§	Ä	Ö	Ü	^	`	ä	ö	ü	ß
CH	6	86	ù	\$	à	é	ç	ê	î	ô	ä	ö	ü	û
SE/FI	2	82	#	¤	É	Ä	Ö	Å	Ü	é	ä	ö	å	ü
DK	8	88	#	\$	@	Æ	Ø	Å	^	`	æ	ø	å	~
NO	9	94	#	\$	@	Æ	Ø	Å	^	`	æ	ø	å	-
IE	73	97	£	\$	Ó	É	Í	Ú	Á	ó	é	í	ú	á
IT	5	85	£	\$	§	°	ç	é	^	ù	à	ò	è	ì
PT	13	92	#	\$	§	Ã	Ç	Õ	^	`	ã	ç	õ	°
ES	10	90	#	\$	§	í	Ñ	¿	^	`	°	ñ	ç	~
ES	51	91	#	\$	·	í	Ñ	Ç	¿	`	´	ñ	ç	¨
<b>COUNTRY</b>	<b>Country Keyboard</b>	<b>Honeywell CodePage</b>	<b>ISO / IEC 646 National Character Replacements</b>											

# Keyboard Key References

6E	70	71	72	73	74	75	76	77	78	79	7A	7B	7C	7D	7E					
01	02	03	04	05	06	07	08	09	0A	0B	0C	0D	0F	4B	50	55	5A	5F	64	69
10	11	12	13	14	15	16	17	18	19	1A	1B	1C	1D	4C	51	56	5B	60	65	6A
1E	1F	20	21	22	23	24	25	26	27	28	29	2B					5C	61	66	
2C	2E	2F	30	31	32	33	34	35	36	37	39			53			5D	62	67	6C
3A	3B	3C			3D				3E	3F	38	40	4F	54	59	63	68			

**104 Key U.S. Style Keyboard**

6E	70	71	72	73	74	75	76	77	78	79	7A	7B	7C	7D	7E					
01	02	03	04	05	06	07	08	09	0A	0B	0C	0D	0F	4B	50	55	5A	5F	64	69
10	11	12	13	14	15	16	17	18	19	1A	1B	1C	2B	4C	51	56	5B	60	65	6A
1E	1F	20	21	22	23	24	25	26	27	28	29	2A					5C	61	66	
2C	2D	2E	2F	30	31	32	33	34	35	36	37	39			53		5D	62	67	6C
3A	3B	3C			3D				3E	3F	38	40	4F	54	59	63	68			

**105 Key European Style Keyboard**

# SAMPLE SYMBOLS

UPC-A



0 123456 7890

Interleaved 2 of 5



01234567890

EAN-13



9 780330 290951

Code 128



Code 128

Code 39

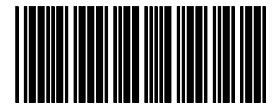

BC321

Codabar

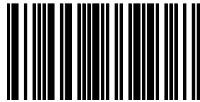

A13579B

Code 93

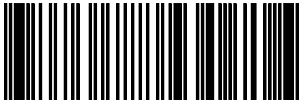

123456-9\$

Straight 2 of 5 Industrial

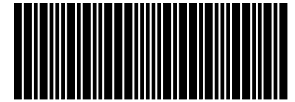

123456

Matrix 2 of 5



6543210

RSS-14



(01) 00123456789012

PDF417



Car Registration

Code 49



1234567890

# SAMPLE SYMBOLS (CONTINUED)

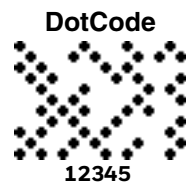
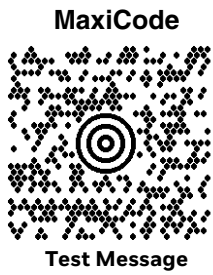



# PROGRAMMING CHART



K0K

0



K2K

2



K4K

4



K6K

6



K8K

8



K1K

1



K3K

3



K5K

5



K7K

7



K9K

9

# PROGRAMMING CHART (CONTINUED)



KAK  
A



KBK  
B



KCK  
C



KDK  
D



KEK  
E



KFK  
F



MNUSAV.  
Save



MNUABT.  
Discard



RESET\_  
Reset

**Note:** If you make an error while scanning the letters or digits (before scanning **Save**), scan **Discard**, scan the correct letters or digits, and **Save** again.



Honeywell  
855 S. Mint St.  
Charlotte, NC 28202

[sps.honeywell.com](http://sps.honeywell.com)