

Honeywell

Voyager XP™ 147X Series

Area-Imaging Scanner

Scanner Models: 1470g, 1472g

Base Model: CCB01-010BT-V1N



User Guide

Disclaimer

Honeywell International Inc. (“HII”) reserves the right to make changes in specifications and other information contained in this document without prior notice, and the reader should in all cases consult HII to determine whether any such changes have been made. HII makes no representation or warranties regarding the information provided in this publication.

HII shall not be liable for technical or editorial errors or omissions contained herein; nor for incidental or consequential damages resulting from the furnishing, performance, or use of this material. HII disclaims all responsibility for the selection and use of software and/or hardware to achieve intended results.

This document contains proprietary information that is protected by copyright. All rights are reserved. No part of this document may be photocopied, reproduced, or translated into another language without the prior written consent of HII.

Copyright © 2019-2022 Honeywell International Inc. All rights reserved.

Web Address: sps.honeywell.com

Microsoft® Windows® is a trademark or registered trademark of Microsoft Corporation

Other product names or marks mentioned in this document may be trademarks or registered trademarks of other companies and are the property of their respective owners.

For patent information, refer to www.hsmpats.com.

TABLE OF CONTENTS

Customer Support	xv
Technical Assistance	xv
Product Service and Repair	xv
Limited Warranty	xv
Chapter 1 - Get Started	1
About This Manual.....	1
Unpack Your Device.....	1
Connect the Device.....	2
Connect with USB.....	2
Connect with Keyboard Wedge	3
Connect with RS232 Serial Port	4
Connect with RS485.....	5
Mount a CCB01-010BT-V1N Charge Base	7
Reading Techniques.....	7
Menu Barcode Security Settings	8
Set Custom Defaults	8
Reset the Custom Defaults.....	9
Chapter 2 - Program the Interface	11
Introduction.....	11
Program the Interface - Plug and Play.....	11
Keyboard Wedge.....	11
Laptop Direct Connect.....	12

RS232 Serial Port.....	12
RS485	12
RS485 Packet Mode.....	13
USB IBM SurePos	14
USB PC or Macintosh Keyboard	14
USB HID.....	15
USB Serial.....	15
CTS/RTS Emulation	15
ACK/NAK Mode.....	15
Remote MasterMind™ for USB	16
Verifone® Ruby Terminal Default Settings	16
Gilbarco® Terminal Default Settings.....	17
Honeywell Bioptic Aux Port Configuration.....	17
Datalogic™ Magellan© Bioptic Aux Port Configuration	17
NCR Bioptic Aux Port Configuration.....	18
Wincor Nixdorf Terminal Default Settings.....	18
Wincor Nixdorf Beetle™ Terminal Default Settings.....	19
Wincor Nixdorf RS232 Mode A.....	19
Keyboard Country Layout.....	20
Keyboard Style	27
Keyboard Conversion	28
Control Character Output.....	29
Keyboard Modifiers.....	29
RS232 Modifiers	31
RS232 Baud Rate	31
RS232 Word Length: Data Bits, Stop Bits, and Parity	32
RS232 Receiver Time-Out	33
RS232 Handshaking.....	33
RS232 Timeout.....	34
XON/XOFF.....	34
ACK/NAK	35
Scanner to Bioptic Communication.....	35

Scanner-Bioptic Packet Mode.....	35
Scanner-Bioptic ACK/NAK Mode.....	36
Scanner-Bioptic ACK/NAK Timeout	36

Chapter 3 - Cordless System Operation37

How the Cordless Charge Base/Access Point Works.....	37
Link the Scanner to a Charge Base.....	37
Link the Scanner to an Access Point	38
Replace a Linked Scanner	39
Communication Between the Cordless System and the Host.....	39
Program the Scanner and Base or Access Point	40
RF (Radio Frequency) Module Operation.....	40
System Conditions.....	40
Link Process.....	40
Scanner Is Out of Range	40
Scanner Is Moved Back Into Range.....	41
Out of Range and Back into Range with Batch Mode On.....	41
Page Button.....	41
About the Battery	41
Charge Information	42
Battery Recommendations	42
Proper Disposal of the Battery	43
Beeper and LED Sequences and Meaning	43
Scanner LED Sequences and Meaning.....	43
Base/Access Point LED Sequences and Meaning.....	44
Base Power Communication Indicator	44
Reset Scanner.....	45
Scan While in Base Cradle.....	45
Base Charging Modes	45
Page.....	46
Page Mode.....	46
Page Pitch.....	47

Error Indicators.....	47
Beeper Pitch - Base Error.....	47
Number of Beeps - Base Error.....	47
Scanner Report.....	48
Scanner Address.....	48
Base or Access Point Address.....	48
Scanner Modes.....	48
Charge Only Mode.....	49
Linked Modes.....	49
Unlink the Scanner.....	50
Override Locked Scanner.....	50
Out-of-Range Alarm.....	50
Alarm Sound Type.....	51
Scanner Power Time-Out Timer.....	52
Flexible Power Management.....	53
Batch Mode.....	53
Batch Mode Beep.....	55
Batch Mode Storage.....	55
Batch Mode Quantity.....	56
Batch Mode Output Order.....	58
Total Records.....	58
Delete Last Code.....	58
Clear All Codes.....	58
Transmit Records to Host.....	59
Batch Mode Transmit Delay.....	59
Multiple Scanner Operation.....	59
Scanner Name.....	60
Application Work Groups.....	61
Application Work Group Selection.....	62
Reset the Factory Defaults: All Application Work Groups.....	62
Reset the Custom Defaults: All Application Work Groups.....	63
Use the Scanner with Bluetooth Devices.....	63
Bluetooth Secure Simple Pairing (SSP).....	63

Bluetooth HID Keyboard Connect.....	64
Virtual Keyboard.....	66
Bluetooth HID Keyboard Disconnect.....	66
Bluetooth Serial Port - PCs/Laptops.....	66
PDA's/Mobility Systems Devices	66
Change the Scanner's Bluetooth PIN Code	67
Minimize Bluetooth/ISM Band Network Activity	67
Auto Reconnect Mode	67
Maximum Link Attempts	68
Relink Time-Out	69
Bluetooth/ISM Network Activity Examples.....	69
Host Acknowledgment.....	70
Host ACK Timeout	72

Chapter 4 - Input/Output Settings 73

Power Up Beeper	73
Beep on BEL Character	74
Trigger Click.....	74
Good Read and Error Indicators.....	74
Beeper – Good Read	74
Beeper Volume – Good Read	75
Beeper Pitch – Good Read	75
Beeper Pitch – Error	75
Beeper Duration – Good Read.....	76
LED – Good Read.....	76
Number of Beeps – Good Read	76
Number of Beeps – Error	77
Good Read Delay.....	77
User-Specified Good Read Delay	78
Manual Trigger Mode	78
LED Illumination - Manual Trigger.....	78
Serial Trigger Mode	79
Read Time-Out.....	79
Presentation Mode	79

Triggered Presentation Mode.....	79
Presentation Centering.....	80
In-Stand Sensor Mode.....	81
Poor Quality Codes.....	82
Poor Quality 1D Codes.....	82
Poor Quality PDF Codes.....	82
CodeGate®.....	83
Mobile Phone Read Mode.....	83
Hands Free Time-Out.....	83
Reread Delay.....	84
User-Specified Reread Delay.....	84
2D Reread Delay.....	84
Character Activation Mode.....	85
Activation Character.....	85
End Character Activation After Good Read.....	86
Character Activation Timeout.....	86
Character Deactivation Mode.....	86
Deactivation Character.....	87
Illumination Lights.....	87
Aimer Delay.....	87
User-Specified Aimer Delay.....	88
Aimer Mode.....	88
Centering.....	88
No Read.....	90
Video Reverse.....	91
Working Orientation.....	92

Chapter 5 - Data Edit 93

Prefix/Suffix Overview.....	93
To Add a Prefix or Suffix:.....	94
Clear One or All Prefixes or Suffixes.....	94
Add a Carriage Return Suffix to All Symbologies.....	95

Prefix Selections	95
Suffix Selections	95
Function Code Transmit.....	96
Intercharacter, Interfunction, and Intermessage Delays	96
Intercharacter Delay.....	96
User Specified Intercharacter Delay	97
Interfunction Delay.....	97
Intermessage Delay	98

Chapter 6 - Data Format99

Data Format Editor Introduction	99
Show Data Format	100
Add a Data Format.....	100
Other Programming Selections	101
Terminal ID Table	102
Data Format Editor Commands	102
Move Commands.....	105
Search Commands.....	106
Miscellaneous Commands	108
Data Formatter.....	111
Primary/Alternate Data Formats	111

Chapter 7 - Symbologies.....113

All Symbologies.....	114
Message Length Description	114
Codabar.....	115
Codabar Concatenation.....	116
Code 39	117
Code 32 Pharmaceutical (PARAF)	119
Full ASCII.....	120
Code 39 Code Page.....	120
Interleaved 2 of 5.....	121
NEC 2 of 5	122

Code 93.....	124
Code 93 Code Page	125
Straight 2 of 5 Industrial (three-bar start/stop).....	125
Straight 2 of 5 IATA (two-bar start/stop).....	126
Matrix 2 of 5.....	127
Code 11.....	128
Code 128.....	129
ISBT 128 Concatenation	129
Code 128 Code Page	130
GS1-128.....	131
UPC-A.....	132
UPC-A/EAN-13 with Extended Coupon Code.....	134
Coupon GS1 DataBar Output	135
UPC-E0.....	135
UPC-E1.....	137
EAN/JAN-13.....	138
Convert UPC-A to EAN-13.....	138
ISBN Translate.....	140
EAN/JAN-8.....	141
MSI.....	143
GS1 DataBar Omnidirectional.....	144
GS1 DataBar Limited	145
GS1 DataBar Expanded	145
Codablock A	146
Codablock F	147
PDF417.....	148
MacroPDF417.....	148
MicroPDF417.....	149
GS1 Composite Codes.....	150
UPC/EAN Version	150
GS1 Emulation.....	151
TCIF Linked Code 39 (TLC39)	152

QR Code	152
QR Code Append	153
QR Code Page	154
Data Matrix	154
Data Matrix Code Page.....	155
MaxiCode.....	155
Aztec Code	156
Aztec Code Page	158
Chinese Sensible (Han Xin) Code.....	158
Postal Codes - 2D.....	159
Single 2D Postal Codes:.....	159
Combination 2D Postal Codes:.....	160
Postal Codes - Linear	163
China Post (Hong Kong 2 of 5).....	163
Korea Post.....	164

Chapter 8 - Utilities..... 167

Add a Test Code I.D. Prefix to All Symbologies	167
Show Decoder Library Version.....	167
Show Software Revision	167
Show Data Format	168
Test Menu.....	168
EZConfig for Scanning Introduction	168
Install EZConfig Cloud for Scanning	169
Reset the Factory Defaults	169

Chapter 9 - Serial Programming Commands 171

Conventions	171
Menu Command Syntax.....	171
Query Commands	172
Trigger Commands.....	174
Reset the Custom Defaults	175

Menu Commands	175
---------------------	-----

Chapter 10 - Product Specifications.....197

Voyager XP 1470g Scanner Product Specifications	197
Voyager XP 1472g Cordless Scanner Product Specifications.....	198
CCB01-010BT-V1N Charge Base Product Specifications.....	199
Depth of Field Charts	200
Typical Performance	200
Guaranteed Performance	201
Standard Cable Pinouts	201
Keyboard Wedge.....	202
Serial Output.....	202
USB	203
RS485 Output.....	203

Chapter 11 - Maintenance and Troubleshooting207

Repairs	207
Maintenance.....	207
Clean the Scanner.....	207
Clean the Window	208
About Disinfectant-ready Models	208
Inspect Cords and Connectors	208
Replace Cables in Corded Scanners	208
Replace a Corded Scanner Interface Cable.....	209
Replace Cables and Batteries in Cordless Systems.....	209
Replace an Interface Cable in a Base.....	209
Change a Cordless Scanner Battery.....	210
Troubleshoot a Corded Scanner	210
Troubleshoot a Cordless System	211
Troubleshoot a Base.....	211
Troubleshoot a Cordless Scanner.....	211

Appendix A - Reference Charts.....	213
Symbology Charts.....	213
Linear Symbologies	213
2D Symbologies	214
Postal Symbologies	215
ASCII Conversion Chart (Code Page 1252)	216
Lower ASCII Reference Table.....	217
ISO 2022/ISO 646 Character Replacements	220
Keyboard Key References.....	223
 Sample Symbols.....	 225
 Programming Chart	 227

Customer Support

Technical Assistance

Go to honeywell.com/PSStechnicalsupport to search our knowledge base for a solution or to log into the Technical Support portal.

For our latest contact information, see honeywell.com/PSSlocations.

Product Service and Repair

Honeywell International Inc. provides service for all of its products through service centers throughout the world. Go to sps.honeywell.com and select **Support** to find a service center near you or to get a Return Material Authorization number (RMA #) before returning a product.

Limited Warranty

For warranty information, go to sps.honeywell.com and click **Support > Warranties**.

About This Manual

This User Guide provides installation and programming instructions for the Voyager XP™ 1470g corded area-imaging scanners and 1472g cordless area-imaging scanners. Product specifications, dimensions, warranty, and customer support information are also included.

Note: *The selections in this User Guide are dependent on the Voyager XP 147Xg model you have purchased.*

PDF and 2 dimensional barcodes can only be read by model 147Xg2D and cannot be read by model 147Xg1D.

Honeywell barcode scanners are factory programmed for the most common terminal and communications settings. If you need to change these settings, programming is accomplished by scanning the barcodes in this guide.

An asterisk (*) next to an option indicates the default setting.

Unpack Your Device

After you open the shipping carton containing the product, take the following steps:

- Check for damage during shipment. Report damage immediately to the carrier who delivered the carton.
- Make sure the items in the carton match your order.
- Save the shipping container for later storage or shipping.

Connect the Device

Connect with USB

A scanner or a cordless base can be connected to the USB port of a computer.

1. Connect the appropriate interface cable to the device first, then to the computer.

Corded Voyager XP 1470g USB Connection:

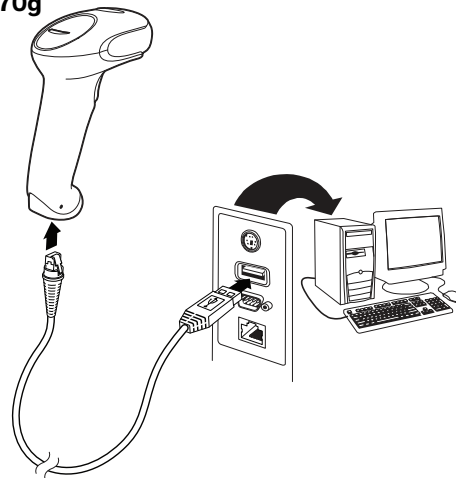

CCB01-010BT-V1N Base USB Connection:

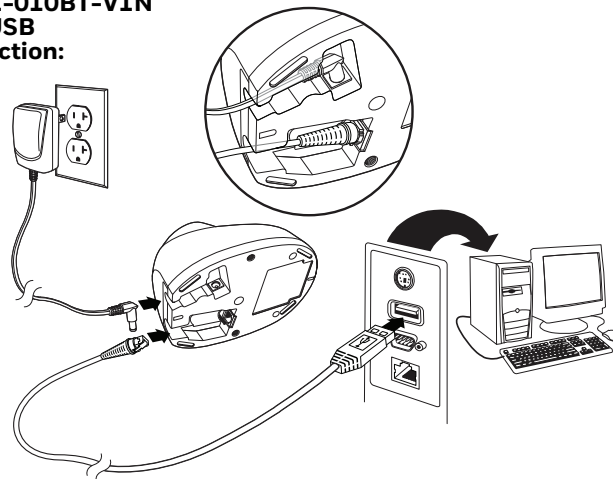

Note: The power supply must be ordered separately, if needed.

2. If you connect a CCB01-010BT-V1N Base, make sure the cables are secured in the wireways in the bottom of the cordless base and the base sits flat on a horizontal surface.
3. The scanner beeps.
4. Verify the scanner or cordless base operation by scanning a barcode from the [Sample Symbols](#) in the back of this manual.

The unit defaults to a USB PC Keyboard. Refer to [page 14](#) for other USB terminal settings.

Connect with Keyboard Wedge

A scanner or cordless base can be connected between the keyboard and PC as a “keyboard wedge,” where the scanner provides data output that is similar to keyboard entries. The following is an example of a keyboard wedge connection:

1. Turn off power and disconnect the keyboard cable from the back of the terminal/computer.
2. Connect the appropriate interface cable to the device and to the terminal/computer.

Corded Voyager XP 1470g Keyboard Wedge Connection:

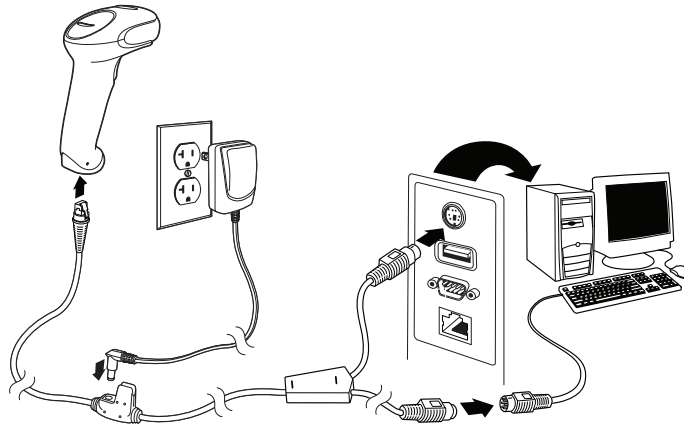

CCB01-010BT-V1N Base Keyboard Wedge Connection:

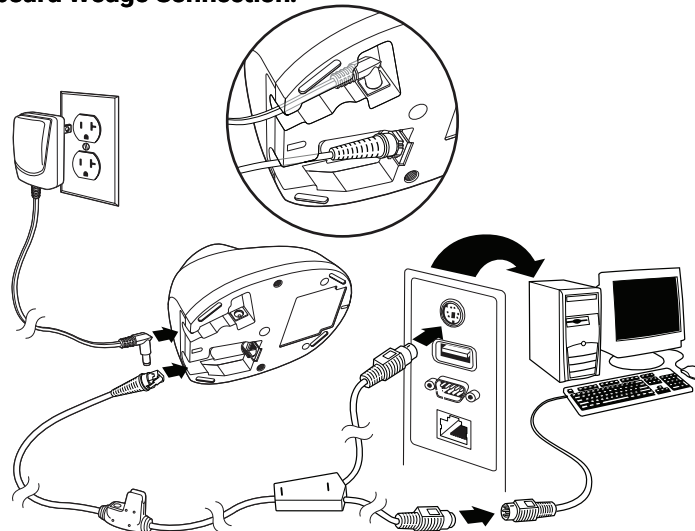

Note: The power supply must be ordered separately, if needed.

3. If you are connecting a CCB01-010BT-V1N Base, make sure the cables are secured in the wireways in the bottom of the cordless base and the base sits flat on a horizontal surface.
4. Turn the terminal/computer power back on. The scanner beeps.
5. Verify the scanner or cordless base operation by scanning a barcode from the [Sample Symbols](#) in the back of this manual. The scanner beeps once.

The unit defaults to an IBM PC AT and compatibles keyboard wedge interface with a USA keyboard. A carriage return (CR) suffix is added to barcode data.

Connect with RS232 Serial Port

1. Turn off power to the terminal/computer.
2. Connect the appropriate interface cable to the device.

Note: For the scanner or cordless base to work properly, you must have the correct cable for your type of terminal/computer.

Corded Voyager XP 1470g RS232 Serial Port Connection:

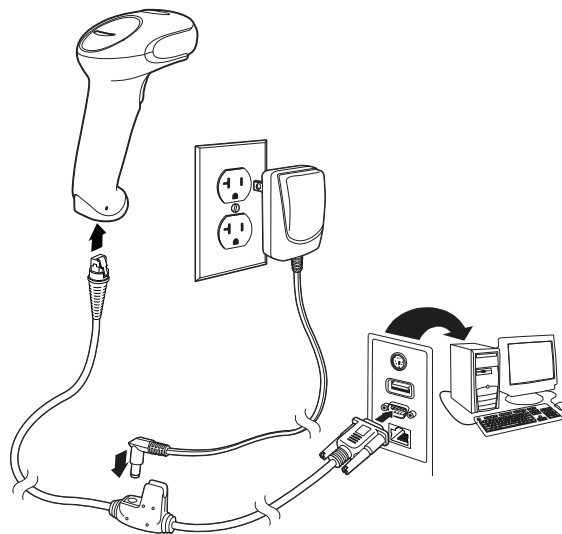

**CCB01-010BT-V1N Base
RS232 Serial Port Connection:**

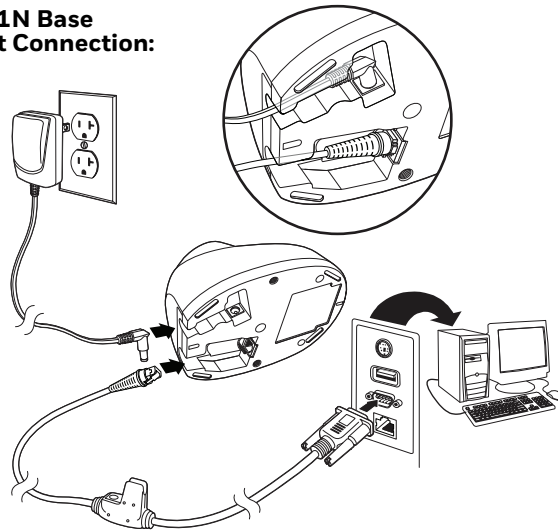

Note: The power supply must be ordered separately, if needed.

1. If you are connecting a CCB01-010BT-V1N Base, make sure the cables are secured in the wireways in the bottom of the cordless base and the base sits flat on a horizontal surface.
2. Plug the serial connector into the serial port on your computer. Tighten the two screws to secure the connector to the port.
3. Once the scanner or cordless base has been fully connected, power up the computer.

This interface programs 115,200 baud, 8 data bits, no parity, and 1 stop bit.

Connect with RS485

A scanner or cordless base can be connected for an IBM POS terminal interface.

1. Connect the appropriate interface cable to the device, then to the computer.

**Corded Voyager XP 1470g
RS232 Serial Port Connection:**

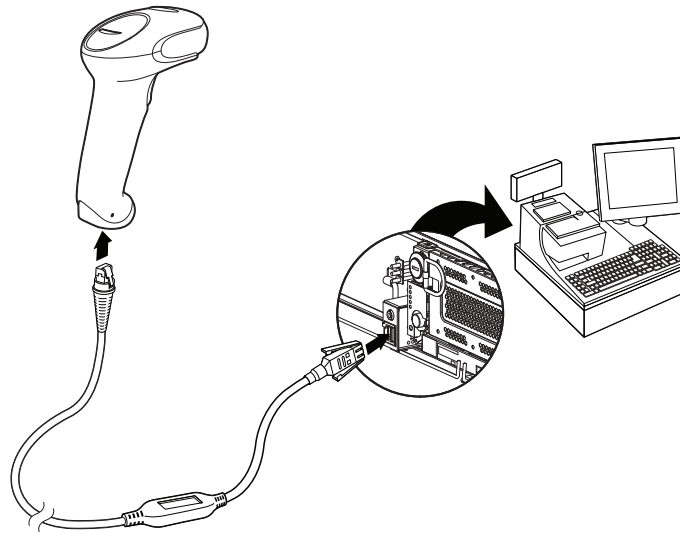

**CCB01-010BT-V1N Base
RS485 Connection:**

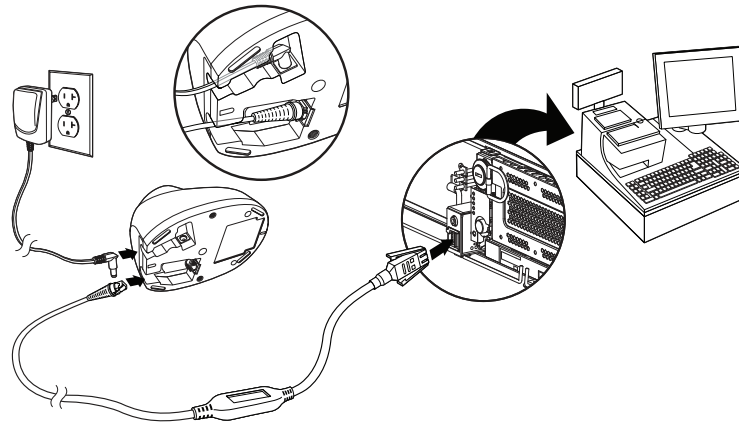

2. Turn the terminal/computer power back on. The scanner beeps.
3. Verify the scanner or cordless base operation by scanning a barcode from the [Sample Symbols](#) in the back of this manual. The scanner beeps once.

For further RS485 settings, refer to [RS485](#), page 12.

Mount a CCB01-010BT-V1N Charge Base

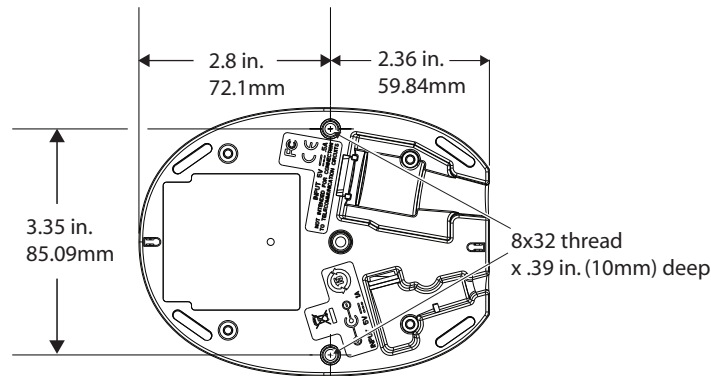

Reading Techniques

The scanner has a view finder that projects a bright red aiming dot that corresponds to the scanner's horizontal field of view. The aiming dot should be centered over the barcode, but it can be positioned in any direction for a good read.

Linear barcode



2D Matrix symbol



The aiming dot is smaller when the scanner is closer to the code and larger when it is farther from the code. Symbologies with smaller bars or elements (mil size) should be read closer to the unit. Symbologies with larger bars or elements (mil size) should be read farther from the unit. To read single or multiple symbols (on a page or on an object), hold the scanner at an appropriate distance from the target, press the trigger, and center the aiming dot on the symbol. If the code being scanned is highly reflective (e.g., laminated), it may be necessary to tilt the code up 15° to 18° to prevent unwanted reflection.

Menu Barcode Security Settings

Honeywell scanners are programmed by scanning menu barcodes or by sending serial commands to the scanner. If you want to restrict the ability to scan menu codes, you can use the Menu Barcode Security settings. Please contact the nearest technical support office (see [Customer Support](#) on page xv) for further information.

Set Custom Defaults

You have the ability to create a set of menu commands as your own, custom defaults. To do so, scan the **Set Custom Defaults** barcode below before scanning the menu commands for your custom defaults. If a menu command requires scanning numeric codes from the [Programming Chart](#), then a **Save** code, that entire sequence will be saved to your custom defaults. When you have entered all the commands you want to save for your custom defaults, scan the **Save Custom Defaults** barcode.



Note: *When using a cordless system, the Custom Defaults settings apply to all workgroups. Scanning the **Save Defaults** barcode also causes both the scanner and the base or Access Point to perform a reset and become unlinked. The scanner must be placed in its base to re-establish the link before any setup codes are entered. If using an Access Point, the linking barcode must be scanned. See [Cordless System Operation](#) beginning on page 37 for additional information.*

You may have a series of custom settings and want to correct a single setting. To do so, just scan the new setting to overwrite the old one. For example, if you had previously saved the setting for Beeper Volume at Low to your custom defaults, and decide you want the beeper volume set to High, just scan the **Set Custom Defaults** barcode, then scan the **Beeper Volume High** menu code, and then **Save Custom Defaults**. The rest of the custom defaults will remain, but the beeper volume setting will be updated.

Reset the Custom Defaults

If you want the custom default settings restored to your scanner, scan the **Activate Custom Defaults** barcode below. This is the recommended default barcode for most users. It resets the scanner to the custom default settings. If there are no custom defaults, it will reset the scanner to the factory default settings. Any settings that have not been specified through the custom defaults will be defaulted to the factory default settings.



DEFAULT.

Activate Custom Defaults

Note: *If using a cordless system, scanning this barcode also causes both the scanner and the base or Access Point to perform a reset and become unlinked. The scanner must be placed in its base to re-establish the link. If using an Access Point, the linking barcode must be scanned. See [Cordless System Operation](#) beginning on page 37 for additional information.*

Introduction

This chapter describes how to program your system for the desired interface.

Program the Interface - Plug and Play

Plug and Play barcodes provide instant scanner set up for commonly used interfaces.

Note: After you scan one of the codes, power cycle the host terminal to have the interface in effect.

Keyboard Wedge

If you want your system programmed for an IBM PC AT and compatibles keyboard wedge interface with a USA keyboard, scan the barcode below. Keyboard wedge is the default interface.

Note: The following barcode also programs a carriage return (CR) suffix.



PAP_AT.

IBM PC AT and Compatibles with
CR suffix

Laptop Direct Connect

For most laptops, scanning the **Laptop Direct Connect** barcode allows operation of the scanner in parallel with the integral keyboard. The following **Laptop Direct Connect** barcode also programs a carriage return (CR) suffix and turns on Emulate External Keyboard (page 28).



PAPLTD.

**Laptop Direct Connect
with CR suffix**

RS232 Serial Port

The **RS232 Interface** barcode is used when connecting to the serial port of a PC or terminal. The following **RS232 Interface** barcode also programs a carriage return (CR) and a line feed (LF) suffix, baud rate, and data format as indicated below. It also changes the trigger mode to manual.

Option	Setting
Baud Rate	115,200 bps
Data Format	8 data bits, no parity bit, 1 stop bit



PAP232.

RS232 Interface

RS485

Scan one of the following “Plug and Play” codes to program the scanner for an IBM POS terminal interface.

Note: After scanning one of these codes, you must power cycle the cash register.



PAPP5B.

IBM Port 5B Interface



PAP9B1.

**IBM Port 9B
HHBCR-1 Interface**



Each barcode above also programs the following suffixes for each symbology:

Symbology	Suffix	Symbology	Suffix
EAN 8	0C	Code 39	00 0A 0B
EAN 13	16	Interleaved 2 of 5	00 0D 0B
UPC A	0D	Code 128 *	00 0A 0B
UPC E	0A	Code 128 **	00 18 0B
		MaxiCode	00 2F 0B

* Suffixes programmed for Code 128 with IBM 4683 Port 5B, IBM 4683 Port 9B HHBCR-1, and IBM 4683 Port 17 Interfaces

** Suffixes programmed for Code 128 with IBM 4683 Port 9 HHBCR-2 Interface

RS485 Packet Mode

The following selection allows you to break up large barcode data into smaller packets on an IBM POS terminal. To break up large barcodes into small packets, scan the **Packet Mode On** barcode below. Scan the **Packet Mode Off** barcode if you want large barcode data to be sent to the host in a single chunk. *Default = Packet Mode Off.*



RS485 Packet Length

If you are using Packet mode, you can specify the size of the data “packet” that is sent to the host. Scan the **Packet Length** barcode, then the packet size (from 20 - 256) from the [Programming Chart](#), then **Save**. *Default = 40.*



USB IBM SurePos

Scan one of the following “Plug and Play” codes to program the scanner for an IBM SurePos (USB handheld scanner) or IBM SurePos (USB tabletop scanner) interface.

Note: After scanning one of these codes, you must power cycle the cash register.



Each barcode above also programs the following suffixes for each symbology:

Symbology	Suffix	Symbology	Suffix
EAN 8	0C	Code 39	00 0A 0B
EAN 13	16	Interleaved 2 of 5	00 0D 0B
UPC A	0D	Code 128	00 18 0B
UPC E	0A	Code 39	00 0A 0B

USB PC or Macintosh Keyboard

Scan one of the following codes to program the scanner for USB PC Keyboard or USB Macintosh Keyboard. Scanning these codes also adds a CR and LF.



USB HID

Scan the following code to program the scanner for USB HID barcode scanners.



PAP131.

USB HID Barcode Scanner

USB Serial

Scan the following code to program the scanner to emulate a regular RS232-based COM Port. If you are using a Microsoft® Windows® PC, you will need to download a driver from the Honeywell website (sps.honeywell.com). The driver will use the next available COM Port number. Apple® Macintosh computers recognize the scanner as a USB CDC class device and automatically uses a class driver.



TRMUSB130.

USB Serial

Note: No extra configuration (e.g., baud rate) is necessary.

CTS/RTS Emulation



USBCTS1.

CTS/RTS Emulation On



USBCTS0.

*** CTS/RTS Emulation Off**

ACK/NAK Mode



USBACK1.

ACK/NAK Mode On



USBACK0.

*** ACK/NAK Mode Off**

Remote MasterMind™ for USB

When using a USB interface, you may wish to configure your scanner to communicate with Remote MasterMind Scanner Management Software (ReM). Scan the **ReM On** barcode to communicate with ReM. To disable this capability, scan **ReM Off**. *Default = ReM On.*

Note: *Remote MasterMind settings apply only to the Voyager XP 1470g. They are not supported by the Voyager XP 1472g.*



REMIFC0.
ReM Off



REMIFC1.
* ReM On

Verifone® Ruby Terminal Default Settings

Scan the following Plug and Play code to program the scanner for a Verifone Ruby terminal. This barcode sets the baud rate to 1200 bps and the data format to 8 data bits, mark parity bit, 1 stop bit. It also adds a line feed (LF) suffix and programs the following prefixes for each symbology:

Symbology	Prefix
UPC-A	A
UPC-E	A
EAN-8	FF
EAN-13	F



PAPRBY.
Verifone Ruby Settings

Gilbarco[®] Terminal Default Settings

Scan the following Plug and Play code to program the scanner for a Gilbarco terminal. This barcode sets the baud rate to 2400 bps and the data format to 7 data bits, even parity, 2 stop bits. It also adds a carriage return (CR) suffix and programs the following prefixes for each symbology:

Symbology	Prefix
UPC-A	A
UPC-E	EO
EAN-8	FF
EAN-13	F



PAPGLB.

Gilbarco Settings

Honeywell Bioptic Aux Port Configuration

Scan the following Plug and Play code to program the scanner for a Honeywell bioptic scanner auxiliary port configuration. This barcode sets the baud rate to 38400 bps and the data format to 8 data bits, no parity, 1 stop bit.



PAPBIO.

Honeywell Bioptic Settings

Datalogic[™] Magellan[©] Bioptic Aux Port Configuration

Scan the following Plug and Play code to program the scanner for a Datalogic Magellan bioptic scanner auxiliary port configuration. This barcode sets the baud rate to 9600 bps and the data format to 8 data bits, no parity, 1 stop bit.



PAPMAG.

Datalogic Magellan Bioptic Settings

NCR Bioptic Aux Port Configuration

Scan the following Plug and Play code to program the scanner for an NCR bioptic scanner auxiliary port configuration. The following prefixes are programmed for each symbology:

Symbology	Prefix	Symbology	Prefix
UPC-A	A	Interleaved 2 of 5	b
UPC-E	E0	Code 128	f
		GS1 DataBar Omnidirectional	r
EAN-8	FF	GS1 DataBar Expanded	r
EAN-13	F	Codabar	N
Code 39	a	Code 32 Pharmaceutical (PARAF)	a

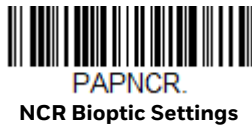

Wincor Nixdorf Terminal Default Settings

Scan the following Plug and Play code to program the scanner for a Wincor Nixdorf terminal. This barcode sets the baud rate to 9600 bps and the data format to 8 data bits, no parity, 1 stop bit.



Wincor Nixdorf Beetle™ Terminal Default Settings

Scan the following Plug and Play code to program the scanner for a Wincor Nixdorf Beetle terminal. This barcode sets the baud rate to 115200 bps and the data format to 8 data bits, no parity, 1 stop bit. The following prefixes are programmed for each symbology:

Symbology	Prefix	Symbology	Prefix
Aztec Code	V	Interleaved 2 of 5	I
Codabar	N	MaxiCode	T
Code 93	L	MicroPDF417	S
Code 128	K	PDF417	Q
Data Matrix	R	QR Code	U
EAN-8	B	Straight 2 of 5 IATA	H
EAN-13	A	UPC-A	A0
GS1 DataBar	E	UPC-E	C
GS1-128	P	All other barcodes	M



PAPBTL

Wincor Nixdorf Beetle Settings

Wincor Nixdorf RS232 Mode A

Scan the following Plug and Play code to program the scanner for a Wincor Nixdorf RS232 Mode A terminal. This barcode sets the baud rate to 9600 bps and the data format to 8 data bits, odd parity, 1 stop bit. The following prefixes are programmed for each symbology:

Symbology	Prefix	Symbology	Prefix
Code 128	K	EAN-13	A
Code 93	L	GS1-128	K
Codabar	N	Interleaved 2 of 5	I
UPC-A	A0	Plessey	O
UPC-E	C	Straight 2 of 5 IATA	H
EAN-8	B	GS1 DataBar	E
All other barcodes	M		



PAPWMA

Wincor Nixdorf RS232 Mode A Settings

Keyboard Country Layout

If your interface is USB Keyboard or Keyboard Wedge, your keyboard layout default is a US keyboard. To change this layout, refer to the chart below for your keyboard country. Scan the appropriate barcode below to change the layout.

By default, national character replacements are used for the following characters: # \$ @ [\] ^ { | } ~

See [ISO 2022/ISO 646 Character Replacements](#) on page 220 to view the character replacements for each country.

Keyboard Countries



KBDCTY0.
* United States



KBDCTY35.
Albania



KBDCTY81.
Azeri (Cyrillic)



KBDCTY80.
Azeri (Latin)



KBDCTY82.
Belarus



KBDCTY1.
Belgium



KBDCTY33.
Bosnia



KBDCTY16.
Brazil



KBDCTY59.
Brazil (MS)

Keyboard Countries (Continued)



KBDCTY53.
Bulgaria (Latin)



KBDCTY18.
Canada (French)



KBDCTY32.
Croatia



KBDCTY40.
Czech (Programmers)



KBDCTY38.
Czech (QWERTZ)



KBDCTY52.
Bulgaria (Cyrillic)



KBDCTY54.
Canada (French legacy)



KBDCTY55.
Canada (Multilingual)



KBDCTY15.
Czech



KBDCTY39.
Czech (QWERTY)



KBDCTY8.
Denmark

Keyboard Countries (Continued)



KBDCTY11.
Dutch (Netherlands)



KBDCTY83.
Faroese



KBDCTY3.
France



KBDCTY4.
Germany



KBDCTY64.
Greek (220 Latin)



KBDCTY65.
Greek (319 Latin)



KBDCTY41.
Estonia



KBDCTY2.
Finland



KBDCTY84.
Gaelic



KBDCTY17.
Greek



KBDCTY61.
Greek (220)



KBDCTY62.
Greek (319)

Keyboard Countries (Continued)



KBDCTY63.
Greek (Latin)



KBDCTY60.
Greek (Polytonic)



KBDCTY50.
Hungarian (101 key)



KBDCTY75.
Iceland



KBDCTY56.
Italian (142)



KBDCTY28.
Japan ASCII



KBDCTY66.
Greek (MS)



KBDCTY12.
Hebrew



KBDCTY19.
Hungary



KBDCTY73.
Irish



KBDCTY5.
Italy

Keyboard Countries (Continued)



KBDCTY79.
Kyrgyz (Cyrillic)



KBDCTY42.
Latvia



KBDCTY44.
Lithuania



KBDCTY34.
Macedonia



KBDCTY86.
Mongolian (Cyrillic)



KBDCTY20.
Poland



KBDCTY78.
Kazakh



KBDCTY14.
Latin America



KBDCTY43.
Latvia (QWERTY)



KBDCTY45.
Lithuania (IBM)



KBDCTY74.
Malta



KBDCTY9.
Norway

Keyboard Countries (Continued)



KBDCTY58.
Polish (Programmers)



KBDCTY25.
Romania



KBDCTY67.
Russian (MS)



KBDCTY21.
SCS



KBDCTY36.
Serbia (Latin)



KBDCTY57.
Polish (214)



KBDCTY13.
Portugal



KBDCTY26.
Russia



KBDCTY68.
Russian (Typewriter)



KBDCTY37.
Serbia (Cyrillic)



KBDCTY22.
Slovakia

Keyboard Countries (Continued)



KBDCTY49.
Slovakia (QWERTY)



KBDCTY48.
Slovakia (QWERTZ)

KBDCTY31.
Slovenia



KBDCTY51.
Spanish variation



KBDCTY10.
Spain



KBDCTY29.
Switzerland (French)



KBDCTY23.
Sweden



KBDCTY85.
Tatar



KBDCTY6.
Switzerland (German)



KBDCTY24.
Turkey Q



KBDCTY27.
Turkey F



KBDCTY76.
Ukrainian

Keyboard Countries (Continued)



KBDCTY7.
United Kingdom



KBDCTY87.
United States (Dvorak)



KBDCTY88.
United States (Dvorak left)



KBDCTY89.
United States (Dvorak right)



KBDCTY30.
United States (International)



KBDCTY77.
Uzbek (Cyrillic)

Keyboard Style

This programs keyboard styles, such as Caps Lock and Shift Lock. If you have used [Keyboard Conversion](#) settings, they will override any of the following Keyboard Style settings. *Default = Regular.*

Regular is used when you normally have the Caps Lock key off.



KBDSTY0.
* Regular

Caps Lock is used when you normally have the Caps Lock key on.



KBDSTY1.
Caps Lock

Shift Lock is used when you normally have the Shift Lock key on (not common to U.S. keyboards).



Automatic Caps Lock is used if you change the Caps Lock key on and off. The software tracks and reflects if you have Caps Lock on or off. This selection can only be used with systems that have an LED that notes the Caps Lock status (AT keyboards).



The **Autocaps via NumLock** barcode should be scanned in countries (e.g., Germany, France) where the Caps Lock key cannot be used to toggle Caps Lock. The NumLock option works similarly to the regular Autocaps, but uses the NumLock key to retrieve the current state of the Caps Lock.



Emulate External Keyboard should be scanned if you do not have an external keyboard (IBM AT or equivalent).



Note: After scanning the **Emulate External Keyboard** barcode, you must power cycle your computer.

Keyboard Conversion

Alphabetic keyboard characters can be forced to be all upper case or all lowercase. So if you have the following barcode: “abc569GK,” you can make the output “ABC569GK” by scanning **Convert All Characters to Upper Case**, or to “abc569gk” by scanning **Convert All Characters to Lower Case**.

These settings override [Keyboard Style](#) selections.

Note: If your interface is a keyboard wedge, first scan the menu code for [Automatic Caps Lock](#) (page 28). Otherwise, your output may not be as expected.

Default = Keyboard Conversion Off.



KBDCNV0.

* Keyboard Conversion Off



KBDCNV1.

Convert All Characters
to Upper Case



KBDCNV2.

Convert All Characters
to Lower Case

Control Character Output

This selection sends a text string instead of a control character. For example, when the control character for a carriage return is expected, the output would display [CR] instead of the ASCII code of 0D. Refer to [ASCII Conversion Chart \(Code Page 1252\)](#) on page 216. Only codes 00 through 1F are converted (the first column of the chart). *Default = Off.*

Note: *Control + ASCII Mode overrides this mode.*



KBDNPE1.

Control Character Output On



KBDNPE0.

* Control Character Output Off

Keyboard Modifiers

This modifies special keyboard features, such as CTRL+ ASCII codes and Turbo Mode.

Control + ASCII Mode On: The scanner sends key combinations for ASCII control characters for values 00-1F. Windows is the preferred mode. All keyboard country codes are supported. DOS mode is a legacy mode, and it does not support all keyboard country codes. New users should use the Windows mode. Refer to [ASCII Conversion Chart \(Code Page 1252\)](#), page 216 for CTRL+ ASCII Values.

Windows Mode Prefix/Suffix Off: The scanner sends key combinations for ASCII control characters for values 00-1F, but it does not translate any prefix or suffix information.

Default = Control + ASCII Mode Off.



KBDCAS2.
**Windows Mode Control + X
Mode On**



KBDCAS0.
*** Control + X Mode Off**



KBDCAS1.
DOS Mode Control + X Mode On



KBDCAS3.
Windows Mode Prefix/Suffix Off

Turbo Mode: The scanner sends characters to a terminal faster. If the terminal drops characters, do not use Turbo Mode. *Default = Off.*



KBDTMD1.
Turbo Mode On



KBDTMD0.
*** Turbo Mode Off**

Numeric Keypad Mode: Sends numeric characters as if entered from a numeric keypad. *Default = Off.*



KBDNPS1.
Numeric Keypad Mode On



KBDNPS0.
*** Numeric Keypad Mode Off**

Automatic Direct Connect Mode: This selection can be used if you have an IBM AT style terminal and the system is dropping characters. *Default = Off.*



RS232 Modifiers

RS232 Baud Rate

Baud Rate sends the data from the scanner to the terminal at the specified rate. The host terminal must be set for the same baud rate as the scanner. *Default = 115200.*





232BAD6.
19200



232BAD7.
38400



232BAD8.
57,600



232BAD9.
* 115,200

RS232 Word Length: Data Bits, Stop Bits, and Parity

Data Bits sets the word length at 7 or 8 bits of data per character. If an application requires only ASCII Hex characters 0 through 7F decimal (text, digits, and punctuation), select 7 data bits. For applications that require use of the full ASCII set, select 8 data bits per character. *Default = 8.*

Stop Bits sets the stop bits at 1 or 2. *Default = 1.*

Parity provides a means of checking character bit patterns for validity. *Default = None.*



232WRD3.
7 Data, 1 Stop, Parity Even



232WRD0.
7 Data, 1 Stop, Parity None



232WRD6.
7 Data, 1 Stop, Parity Odd



232WRD4.
7 Data, 2 Stop, Parity Even



232WRD1.
7 Data, 2 Stop Parity None



232WRD7.

7 Data, 2 Stop, Parity Odd



232WRD5.

8 Data, 1 Stop, Parity Even



232WRD2.

* 8 Data, 1 Stop, Parity None



232WRD8.

8 Data, 1 Stop, Parity Odd

RS232 Receiver Time-Out

The unit stays awake to receive data until the RS232 Receiver Time-Out expires. A manual trigger resets the time-out. When an RS232 receiver is sleeping, a character may be sent to wake up the receiver and reset the time-out. A transaction on the CTS line will also wake up the receiver. The receiver takes 300 milliseconds to completely come up. Change the RS232 receiver time-out by scanning the barcode below, then scanning digits from the [Programming Chart](#), then scanning **Save**. The range is 0 to 300 seconds. *Default = 0 seconds (no time-out - always on).*



232LPT.

RS232 Receiver Time-Out

RS232 Handshaking

RS232 Handshaking allows control of data transmission from the scanner using software commands from the host device. When RTS/CTS is turned Off, no data flow control is used.

Flow Control, No Timeout: The scanner asserts RTS when it has data to send, and will wait indefinitely for CTS to be asserted by the host.

Two-Direction Flow Control: The scanner asserts RTS when it is OK for the host to transmit. The host asserts CTS when it is OK for the device to transmit.

Flow Control with Timeout: The scanner asserts RTS when it has data to send and waits for a delay (see [RS232 Timeout](#) on page 34) for CTS to be asserted by the host. If the delay time expires and CTS is not asserted, the device transmit buffer is cleared and scanning may resume. *Default = RTS/CTS Off.*



232CTS1.

Flow Control, No Timeout



232CTS2.

Two-Direction Flow Control



232CTS3.

Flow Control with Timeout



232CTS0.

*** RTS/CTS Off**

RS232 Timeout

When using Flow Control with Timeout, you must program the length of the delay you want to wait for CTS from the host. Set the length (in milliseconds) for a timeout by scanning the barcode below, then setting the timeout (from 1-5100 milliseconds) by scanning digits from the [Programming Chart](#), then scanning Save.



232DEL.

RS232 Timeout

XON/XOFF

Standard ASCII control characters can be used to tell the scanner to start sending data (XON/XOFF On) or to stop sending data (XON/XOFF Off). When the host sends the XOFF character (DC3, hex 13) to the scanner, data transmission stops. To resume transmission, the host sends the XON character (DC1, hex 11). Data transmission continues where it left off when XOFF was sent. *Default = XON/XOFF Off.*



232XON1.

XON/XOFF On



232XON0.

* XON/XOFF Off

ACK/NAK

After transmitting data, the scanner waits for an ACK character (hex 06) or a NAK character (hex 15) response from the host. If ACK is received, the communications cycle is completed and the scanner looks for more barcodes. If NAK is received, the last set of barcode data is retransmitted and the scanner waits for ACK/NAK again. Turn on the ACK/NAK protocol by scanning the **ACK/NAK On** barcode below. To turn off the protocol, scan **ACK/NAK Off**. *Default = ACK/NAK Off.*



232ACK1.

ACK/NAK On



232ACK0.

* ACK/NAK Off

Scanner to Bioptic Communication

The following settings are used to set up communication between Honeywell scanners and bioptic scanners.

Note: *The scanner's baud rate must be set to 38400 and the RS232 timeout must be set to 3000 in order to communicate with a bioptic scanner. See "RS232 Baud Rate" on page 31, and [RS232 Timeout](#) on page 34 for further information.*

Scanner-Bioptic Packet Mode

Packet Mode On must be scanned to set the scanner's format so it is compatible with a bioptic scanner. *Default = Packet Mode Off.*



232PKT0.

* Packet Mode Off



232PKT2.

Packet Mode On

Scanner-Bioptic ACK/NAK Mode

Bioptic ACK/Nak On must be scanned so the scanner will wait for an ACK or NAK from a bioptic scanner after each packet is sent. The Scanner-Bioptic ACK/NAK Timeout (below) controls how long the scanner will wait for a response. *Default = Bioptic ACK/NAK Off.*



Scanner-Bioptic ACK/NAK Timeout

This allows you to set the length (in milliseconds) for a timeout for a bioptic scanner's ACK/NAK response. Scan the barcode below, then set the timeout (from 1-30,000 milliseconds) by scanning digits from the [Programming Chart](#), then scanning **Save**. *Default = 5100.*



Note: *This chapter applies only to cordless scanning systems. It does not apply to corded scanners.*

How the Cordless Charge Base/Access Point Works

A cordless charge base or an Access Point provides the link between the cordless scanner and the host system. The base/Access Point contains an interface assembly and an RF communication module. The RF communication module performs the data exchange between the cordless scanner and the interface assembly. The control assembly coordinates the central interface activities including: transmitting/receiving commands and data to/from the host system, performing software activities (parameter menuing, visual indicator support, power-on diagnostics), and data translation required for the host system.

The cordless charge base is also a scanner's battery charger. Refer to [Charge Information](#), for additional information.

Link the Scanner to a Charge Base

Turn off power before connecting a base, then power up the computer once the base is fully connected. When the base is connected and powered up, put the scanner in the base to establish a link. The green LED on the base flashes to indicate the scanner's battery is charging.

If the scanner and base have previously been linked, you do not receive any feedback. If this is the first time that the scanner and base are linked, both devices emit a short chirp when their radios link. At this point, that one scanner is linked to one base.

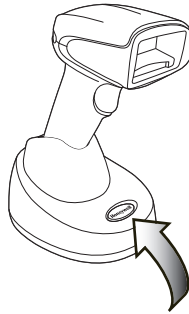

CCB01-010BT-V1N Charge Base

To determine if your cordless system is set up correctly, scan one of the sample barcodes in the back of this manual. If the scanner provides a single good read beep and the green LED lights, the scanner has successfully linked to the base. If you receive an error tone and the red LED lights, the scanner has not linked to the base. Refer to [page 211](#) for troubleshooting information.

Link the Scanner to an Access Point

Turn on the computer (laptop/desktop). Plug the interface cable into the Access Point first and then into the appropriate port on the computer. The Page button lights up when the connection to the host is made.

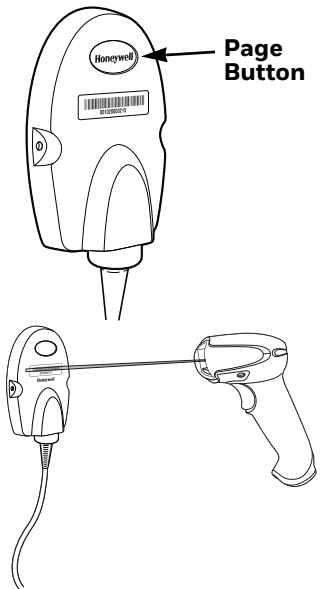

Scan the linking barcode on the top of the Access Point to establish a connection between the Access Point and the scanner. The scanner emits a short beep and flashes the green LED to confirm a connection with the Access Point. The Access Point's Page button remains blue.

Replace a Linked Scanner

If you need to replace a broken or lost scanner that is linked to a base or an Access Point, scan the **Override Locked Scanner** barcode below with a new scanner and place that scanner in the base, or scan the Access Point linking barcode. The locked link will be overridden; the broken or lost scanner's link with the base or Access Point will be removed, and the new scanner will be linked.



BT_RPL1.

**Override Locked Scanner
(Single Scanner)**

Communication Between the Cordless System and the Host

The cordless scanner provides immediate feedback in the form of a “good read” indication with a green LED on the scanner and an audible beep. This indicates that the barcode has been scanned correctly and the base or Access Point has acknowledged receiving the data. This is possible since the cordless system provides two-way communication between the scanner and the base or Access Point.

When data is scanned, the data is sent to the host system via the base or Access Point. The cordless scanner recognizes data acknowledgment (ACK) from the base or Access Point. If it cannot be determined that the data has been properly sent to the base or Access Point, the scanner issues an error indication. You must then check to see if the scanned data was received by the host system.

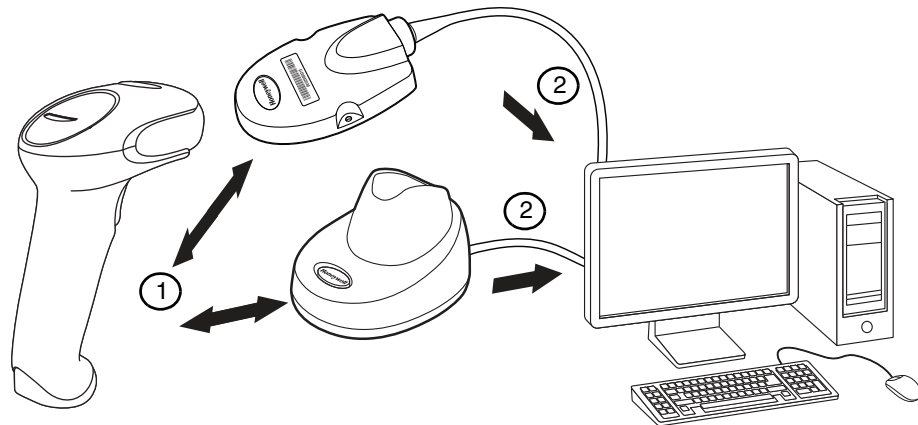

1. Scanner reads code and gets ACK from base or Access Point
2. Base or Access Point sends data to host

Program the Scanner and Base or Access Point

When using the scanner and charge base or Access Point together as a system, menu parameters and configuration settings are stored in the charge base or Access Point. Therefore, when programming any menu configuration settings, the scanner must be linked to the intended charge base or Access Point.

Note: *This only applies when the scanner is linked to a charge base or Access Point. If the scanner is in a non-base mode, configuration settings are stored in the scanner.*

RF (Radio Frequency) Module Operation

The cordless system uses a two-way Bluetooth® radio utilizing adaptive frequency hopping (AFH) to transmit and receive data between the scanner and the base or Access Point. Designed for point-to-point and multipoint-to-single point applications, the radio operates using a license free ISM band, which sends relatively small data packets at a fast data rate over a radio signal with randomly changing frequencies, makes the cordless system highly responsive to a wide variety of data collection applications and resistant to noisy RF environments. The CCB01-010BT-V1N (Bluetooth Class 2) provides a communication range of 33 feet (10m) between the scanner and base or Access Point, depending on the environment. See [Flexible Power Management](#), for information about controlling this range.

System Conditions

The components of the cordless system interact in specific ways as you associate a scanner to a base or Access Point, as you move a scanner out of range, bring a scanner back in range, or swap scanners between two cordless systems. The following information explains the cordless system operating conditions.

Link Process

Once a scanner is placed into a cordless charge base, the scanner's battery charge status is checked, and software automatically detects the scanner and links it to the base depending on the selected link mode.

Refer to [Link the Scanner to an Access Point](#), for information about linking to an Access Point.

Scanner Is Out of Range

The cordless scanner is in communication with its base or Access Point, even when it is not transmitting barcode data. Whenever the scanner can't communicate with the base or Access Point for a few seconds, it is out of range. If the scanner is out of

range and you scan a barcode, the scanner issues an error tone indicating no communication with the base or Access Point. A cordless charge base can also sound an alarm. Refer to [Out-of-Range Alarm](#).

Scanner Is Moved Back Into Range

The scanner relinks if the scanner or the base or Access Point have been reset, or the scanner comes back into range. If the scanner relinks, you will hear a single chirp when the relinking process (uploading of the parameter table) is complete. Refer to [Out-of-Range Alarm](#) for further information.

Out of Range and Back into Range with Batch Mode On

The scanner may store a number of symbols (approximately 5000 U.P.C. symbols; others may vary) when it is out of range and then send them to the base or Access Point when back in range (see [Batch Mode](#)).

You will not hear a communication error tone in this mode, but you will hear a short buzz when you pull the trigger if the radio communication is not working. Once the radio connection is made, the scanner produces a series of beeps while the data is being transferred to the base or Access Point.

Page Button

When you press the Page button on the base or Access Point, the scanners associated with that base or Access Point will begin beeping (3 short and 1 long beep). If you pull the trigger on a scanner that is beeping in response, or press the Page button on the base or Access Point a second time, all associated scanners will stop beeping. See [Page](#) for further information about Page Button settings.

About the Battery



Warning: There is a danger of explosion if the batteries are incorrectly replaced. Replace the batteries with only the same or equivalent type recommended by the manufacturer. Dispose of used batteries according to the recycle program for batteries as directed by the governing agency for the country where the batteries are to be discarded.

Power is supplied to the cordless scanner by a rechargeable battery that is integrated in the scanner handle. Batteries are shipped approximately 30% to 60% charged. The battery should be charged for a minimum of 4 hours before initial use to ensure optimal performance.

Charge Information

The battery is designed to charge while the scanner is positioned in the cordless base unit. Refer to [Base/Access Point LED Sequences and Meaning](#), for an interpretation of the Charge Status indicators. Refer to [Charge Only Mode](#) if you need to charge a scanner without linking it to the base.

Place the scanner in the base that is connected to an appropriate power supply. Use only a Listed Limited Power Source (LPS) or Class 2 type power supply with output rated 5 to 5.2Vdc, 1A.

Note: *If you are powering the base through the interface cable (for example, a USB cable) and not using an external power supply plugged into the aux port, the current available for charging is reduced and charge times are increased.*

Battery Recommendations

- The battery is a lithium ion cell and can be used without a full charge, and can also be charged without fully discharging, without impacting the battery life. There is no need to perform any charge/discharge conditioning on this type of battery.
- Keep the base connected to power when the host is not in use.
- Replace a defective battery immediately since it could damage the scanner.
- Although your battery can be recharged many times, it will eventually be depleted. Replace it after the battery is unable to hold an adequate charge.
- If you are not sure if the battery or charger is working properly, send it to Honeywell International Inc. or an authorized service center for inspection. Refer to [Customer Support](#) for additional information.



Caution: Use only Honeywell Li-ion battery packs, model number BAT-SCN01, rated 3.7 Vdc, 7.4Whr in this device. Use of any non-Honeywell battery may result in damage not covered by the warranty.

Safety Precautions for Lithium Batteries

- Do not place batteries in fire or heat the batteries.
- Do not store batteries near fire or other high temperature locations.
- Do not store or carry batteries together with metal objects.
- Do not expose batteries to water or allow the batteries to get wet.
- Do not connect (short) the positive and negative terminals, of the batteries, to each other with any metal object.
- Do not pierce, strike or step on batteries or subject batteries to strong impacts or shocks.

- Do not disassemble or modify batteries.



Caution: Danger of explosion if batteries are incorrectly replaced. Dispose of used batteries according to the recycle program for batteries as directed by the governing agency for the country where the batteries are to be discarded.

Proper Disposal of the Battery

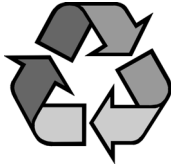

When the battery has reached the end of its useful life, the battery should be disposed of by a qualified recycler or hazardous materials handler. Do not incinerate the battery or dispose of the battery with general waste materials. You may send the scanner's battery to us. (postage paid). The shipper is responsible for complying with all federal, state, and local laws and regulations related to the packing, labeling, manifesting, and shipping of spent batteries. Contact [Customer Support](#) for recycling or disposal information. Since you may find that your cost of returning the batteries significant, it may be more cost effective to locate a local recycle/disposal company.

Beeper and LED Sequences and Meaning

The scanner contains LEDs on the rear of the unit that indicate linking status, decoding state, and battery condition. The base has LEDs on the top of the unit that indicate its power up, communication, and battery charge condition. The red LED = error; green LED = success of any type. Scanners and the CCB01-010BT-V1N base have audible indicators as well: 1 razz or error tone = error; 2 beeps = menu change; 1 beep = all other successes.

The table below lists the indication and cause of the LED indication, beeps, and vibrations for the scanner.

Scanner LED Sequences and Meaning

LED Indication	Beeper Indication	Cause
Normal Operation		
Red Flash	None	Battery low
Green Flash	1 beep	Successful communication or linking
Red, blinking	Razz or error tone	Failed communication
Menu Operation		
Green Flash	2 beeps	Successful menu change
Red, blinking	Razz or error tone	Unsuccessful menu change

Base/Access Point LED Sequences and Meaning

The base contains a red LED and the Access Point has a blue LED that indicate the status of the unit and verify its communication with the host system. The base also has a green LED that indicates scanner battery charge condition.

Red or Blue LED - Host Communication	
Red or Blue LED	Communication Condition
Off	USB suspend
On continuously	Power on, system idle
Short blinks in multiple pulses. Occurs while transferring data to/from the RF module or the Host port.	Receiving data

Green LED - Scanner Battery (base only, does not apply to Access Point)	
Green LED	Charge Condition
Off	Battery not detected or charge suspended
Slow flash, 1 second on, 1 second off	Pre-charge and charging
On continuously	Charge complete
Fast flash, 300 mSec on, 300 mSec off	Charge Error

Base Power Communication Indicator

To display the power indicator on a base or an Access Point, scan the **Base Power Communication Indicator On** barcode. To turn off the power indicator, scan the **Off** barcode. *Default = On.*



BASRED1.

* Base Power Communication Indicator On



BASRED0.

Base Power Communication Indicator Off

Reset Scanner

Scanning this barcode reboots the scanner and causes it to relink with the base or Access Point.



RESET_
Reset Scanner

Scan While in Base Cradle

If you want to be able to scan barcodes while the scanner is in the base cradle, scan the **Scanning in Cradle On** barcode below. If you want to only allow scanning when the scanner is out of the base cradle, scan **Scanning in Cradle Off**. If you want the scanner to shut down when in the base cradle, scan **Shut Down Scanner in Cradle**.
Default = Scanning in Cradle On.



BT_SIC0.
Scanning in Cradle Off



BT_SIC1.
* Scanning in Cradle On



BT_SIC2.
Shut Down Scanner in Cradle

Base Charging Modes

When the base has both an external power supply (plugged into the auxiliary power port) and a host interface cable, it will draw its power from the external power supply. When the base does not have an external power supply, it draws its power from the interface cable. However, the scanner battery charges more slowly from a host interface cable than if auxiliary power were available. Using the following selections, you can specify whether the scanner battery is charged from power supplied via the host interface cable.

When **Base Charge Off** is selected, the scanner battery does not charge when the scanner is in the base cradle.

When **External or Interface Cable Power** is selected, the scanner battery charges from the base's external power supply, if there is one. If there is no external power supply to the base, the scanner battery charges from the interface cable.

When **External Power Only** is selected, the scanner battery only charges from the base's external power supply. If there is no external power supply, the scanner battery does not charge.

Note: If you are using a cordless charge base in *Presentation Mode*, *External Power Only* is the only setting available.

Default = External or Interface Cable Power.



Page

Page Mode

By default, the paging button on the base or Access Point pages the scanners associated with that base or Access Point. If you want the paging button on your base or Access Point to be disabled, scan the **Page Mode Off** barcode, below. When Page Mode is off, the base or Access Point will no longer page scanners when the button is pressed. The red LED on the base or blue LED on the Access Point will remain lit to indicate that Page Mode is off. (This light will go out when the button is pressed, then back on when it's released.) *Default = Page Mode On.*



Page Pitch

When you press the Page button on the base or Access Point, the scanners associated with that base or Access Point will begin beeping (see [Page Button](#)). You can set the pitch of the paging beep for each scanner by scanning one of the following barcodes. *Default = Low.*



Error Indicators

Beeper Pitch - Base Error

The CCB01-010BT-V1N base can be configured to beep at a particular pitch when an error occurs, such as transmission problems to a host system. The beeper pitch codes modify the pitch (frequency) of the error tone the base emits when there is an error. *Default = Low.*



Number of Beeps - Base Error

The number of beeps and LED flashes emitted by the CCB01-010BT-V1N base for an error condition can be programmed from 1 - 9. For example, if you program this option to have five error beeps, there will be five error beeps and five LED flashes in

response to an error. To change the number of error beeps, scan the barcode below and then scan a digit (1-9) barcode and the **Save** barcode on the [Programming Chart](#). *Default = 1.*



BASERR.

Number of Base Error Beeps/LED Flashes

Scanner Report

Scan the barcode below to generate a report for the connected scanners. The report indicates the port, work group, scanner name, and address. To assign a name to your scanner, refer to [Menu Command Syntax](#), page 171.



RPTSCN.

Scanner Report

Scanner Address

Scan the barcode below to determine the address of the scanner you are using.



BT_LDA.

Scanner Address

Base or Access Point Address

Scan the barcode below to determine the address of the base or Access Point you are using.



BASLDA.

Base Address

Scanner Modes

Your scanner is capable of working in single scanner mode, multiple scanner mode, or with Bluetooth devices other than the charge base or Access Point.

Charge Only Mode

There may be times when you want to charge your scanner, but not link to the base. For example, if a scanner is linked to an Access Point or other Bluetooth device and you need to charge the scanner, but want to retain your existing link.

In order to program the base for Charge Only Mode, you must link a scanner to it. Once the scanner is linked to the base, scan the **Charge Only Mode** barcode. Any subsequent scanners placed in that base will charge without linking to it. The scanner used to program the base remains linked to the base. To unlink this scanner, scan [Unlink Scanner](#).



BASLNK0.

Charge Only Mode

Note: *When in Charge Only Mode, the scanner periodically wakes up and beeps. See [Power Up Beeper](#) to change this setting.*

If you want to charge a scanner and link to the base, use Charge and Link Mode. If the base is programmed for Charge Only Mode, you must link a scanner to it first in order to program it for Charge and Link Mode. Scan the linking barcode on the base to link the scanner, then scan **Charge and Link Mode**. *Default = Charge and Link Mode.*



BASLNK1.

*** Charge and Link Mode**

Linked Modes

Locked Link Mode and Open Link Mode are the link modes that accommodate different applications. Scan the appropriate barcodes included in the Open Link and Locked Link Mode explanations that follow to switch from one mode to another. *Default = Open Link Mode.*

Locked Link Mode - Single Scanner

If you link a scanner to a base or an Access Point using the Locked Link Mode, other scanners are blocked from being linked if they are inadvertently placed into the base, or if the Access Point linking barcode is scanned. If you do place a different scanner into a base, it will charge the scanner, but the scanner will not be linked.



BASCON0,DNG1.

**Locked Link Mode
(Single Scanner)**

To use a different scanner, you need to unlink the original scanner by scanning the Unlink Scanner barcode. (See [Scanner Modes](#).)

Open Link Mode - Single Scanner

When newly shipped or defaulted to factory settings, a scanner is not linked to a base or an Access Point. A link is established when the scanner is placed into a base, or an Access Point linking barcode is scanned. When in Open Link Mode, a new link is established when a new scanner is placed in the base, or you scan an Access Point linking barcode. Each time a scanner is placed into a base or scans an Access Point linking barcode, the scanner becomes linked to the base or Access point and the old scanner is unlinked.



Unlink the Scanner

If a base or an Access Point has a scanner linked to it, that scanner must be unlinked before a new scanner can be linked. Once the previous scanner is unlinked, it will no longer communicate with the base or Access Point. To unlink the scanner from a base or an Access Point, scan the **Unlink Scanner** barcode below.



Override Locked Scanner

If you need to replace a broken or lost scanner that is linked to a base or an Access Point, scan the **Override Locked Scanner** barcode below with a new scanner and place that scanner in the base, or scan the Access Point linking barcode. The locked link will be overridden; the broken or lost scanner's link with the base or Access Point will be removed, and the new scanner will be linked.



Out-of-Range Alarm

If your scanner is out range of the base, an alarm sounds from both your base and scanner. If your scanner is out range of an Access Point, an alarm sounds from just the scanner. The alarm stops when the scanner is moved closer to the base or

Access Point, when the base or Access Point connects to another scanner, or when the alarm duration expires. To activate the alarm options for the scanner or the base and to set the alarm duration, scan the appropriate barcode below and then set the timeout duration (from 0-3000 seconds) by scanning digits on the [Programming Chart](#), then scanning **Save**. *Default = 0 sec (no alarm).*



Note: *The Access Point does not have a base alarm.*



Note: *If you are out of range when you scan a barcode, you will receive an error tone even if you do not have the alarm set. You receive the error tone since the data could not be communicated to the base or Access Point or the host.*

Alarm Sound Type

You may change the alarm type for the scanner or a CCB01-010BT-V1N base by scanning the appropriate barcode below and then scanning a digit (0-7) barcode and the **Save** barcode on the [Programming Chart](#). *Default = 0.*

The sounds are as follows:

Setting	Sound
0	3 long beeps, medium pitch
1	3 long beeps, high pitch
2	4 short beeps, medium pitch
3	4 short beeps, high pitch
4	single chirps, medium pitch
5	2 chirps, then 1 chirp, medium pitch
6	single chirps, high pitch
7	2 chirps, then 1 chirp, high pitch





Scanner Power Time-Out Timer

Note: *Scanner Power Time-out Timer only applies to cordless systems. It does not apply to corded scanners.*

When there is no activity within a specified time period, the scanner enters low power mode. Scan the appropriate scanner power time-out barcode to change the time-out duration (in seconds).

Note: *Scanning zero (0) is the equivalent of setting no time-out.*

If there are no trigger pulls during the timer interval, the scanner goes into power down mode. Whenever the trigger is enabled, the timer is reset. If the scanner is placed in the charge base cradle and the battery is in the process of being charged, the scanner will not go into power down mode. *Default = 3600 seconds.*



Note: *When the scanner is in power down mode, pull the trigger to power the unit back up. There will be a set of power up beeps and a delay of up to a few seconds for the radio to join. The scanner will then be ready to use.*

Flexible Power Management

If you are experiencing network performance issues, and suspect the scanner is interfering with other devices, you can turn down the power output of the scanner. This reduces the range between the scanner and a base or an Access Point as shown in the following illustration:

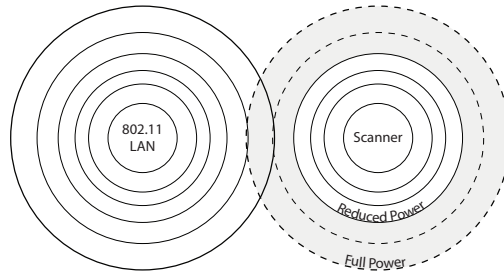

Scan one of the barcodes below to set the scanner's power output to Full Power (100%), Medium Power (35%), Medium Low Power (5%), or Low Power (1%).
Default = Full Power.



BT_TXP100.
* Full Power



BT_TXP35.
Medium Power



BT_TXP5.
Medium Low Power



BT_TXP1.
Low Power

Batch Mode

Note: *Batch Mode is only supported by the Honeywell Charge and Communication Base (CCB) and Honeywell Access Point (AP).*

Batch mode is used to store barcode data when a scanner is out of range of its base or Access Point, or when performing inventory. The data is transmitted to the base or Access Point once the scanner is back in range or when the records are manually transmitted.

Note: *Batch mode has limitations when using multiple scanners to one base or Access Point. If a cordless system is being used in “multiple link mode” where up to 3 scanners are to be connected to one base or Access Point (if supported), some accumulated or batched scans could be lost if scanners are constantly being moved in and out of range.*

Automatic Batch Mode stores barcode data when the scanner is out of range of the base or Access Point. The data is automatically transmitted to the base or Access Point once the scanner is back in range. When the scanner’s buffer space is full, any barcodes scanned generate an error tone. In order to scan barcodes again, the scanner must be moved back into range of the base or Access Point so data can be transmitted.

Inventory Batch Mode stores barcode data, whether or not you are in range of the base or Access Point. To transmit the stored data to the base or Access Point, either place the scanner in the base, or scan [Transmit Inventory Records](#). When the scanner’s buffer space is full, any barcodes scanned generate an error tone. In order to scan barcodes again, the data must be transmitted to the base or Access Point. Once the data is transmitted, it is cleared in the scanner.

Persistent Batch Mode is the same as Inventory Batch Mode, except that once the data is transmitted to the base or Access Point, it is retained in the scanner. If you want to transmit more than once, you can do so using this mode. In order to clear the scanner’s buffer, you must scan [Clear All Codes](#).

Default = Batch Mode Off.



BATENA0.

* Batch Mode Off



BATENA1.

Automatic Batch Mode



BATENA2.

Inventory Batch Mode



BATENA3.

Persistent Batch Mode

Batch Mode Beep

When scanning in [Inventory Batch Mode](#), the scanner beeps every time a barcode is scanned. When Batch Mode Beep is On, you will also hear a click when each barcode is sent to the host. If you do not want to hear these clicks, scan **Batch Mode Beep Off**. *Default = Batch Mode Beep On.*



Batch Mode Storage

When a scanner is storing data during a Batch Mode process, you can select whether the data is stored in Flash memory or in RAM.

Flash Storage: The scanner writes any untransmitted data to flash memory prior to powering down. The data will still be there when the scanner powers back up. However, the scanner will power down, even with untransmitted data, if it reaches a power down timeout or if the battery power is very low.

RAM Storage: The scanner will not power down while it contains data that has not been transmitted to the base or Access Point, even if it reaches a power down timeout. However, if the scanner runs out of battery power, it will power down and the data will be lost.

Default = Flash Storage.



Batch Mode Quantity

When in Batch Mode, you may wish to transmit the number of multiple barcodes scanned, rather than a single barcode multiple times. For example, if you scan three barcodes called XYZ with Batch Mode Quantity Off, when you transmit your data it will appear as XYZ three times. Using Batch Mode Quantity On and the Quantity Codes ([page 57](#)), you could output your data as “XYZ, 00003” instead.

Note: *If you wish to format your output, for example, place a CR or tab between the barcode data and the quantity, refer to [Data Format](#) beginning on page 99.*

Default = Batch Mode Quantity Off.



BATQTY0.

* Batch Mode Quantity Off



BATQTY1.

Batch Mode Quantity On

Enter Quantities

Quantity Codes ([page 57](#)) allow you to enter a quantity for the last item scanned, up to 9999 (default = 1). Quantity digits are shifted from right to left, so if a 5th digit is scanned, the 1st digit scanned is discarded and the 2nd, 3rd and 4th digits are moved to the left to accommodate the new digit.

For example, if the Quantity 5 barcode is scanned after the quantity has been set to 1234, then the 1 is dropped, the quantity will be 2345.

Example: Add a quantity of 5 for the last item scanned.

1. Scan the item's barcode.
2. Scan the quantity **5** barcode.

Example: Add a quantity of 1,500 for the last item scanned.

1. Scan the item's barcode.
2. Scan the quantity **1** barcode.
3. Scan the quantity **5** barcode.
4. Scan the quantity **0** barcode.
5. Scan the quantity **0** barcode.

Example: Change a quantity of 103 to 10.

To correct an incorrect quantity, scan the quantity 0 barcode to replace the incorrect digits, then scan the correct quantity barcodes.

1. Scan the quantity **0** barcode to change the quantity to 1030.
2. Scan the quantity **0** barcode to change the quantity to 0300.
3. Scan the quantity **1** barcode to change the quantity to 3001.
4. Scan the quantity **0** barcode to change the quantity to 0010.

Default = 1.

Quantity Codes



BATNUM0.

0



BATNUM1.

1



BATNUM2.

2



BATNUM3.

3



BATNUM4.

4



BATNUM5.

5



BATNUM6.

6



BATNUM7.

7



BATNUM8.

8



Batch Mode Output Order

When batch data is transmitted, select whether you want that data sent as FIFO (first-in first-out), or LIFO (last-in first-out). *Default = Batch Mode FIFO.*



Total Records

If you wish to output the total number of barcodes scanned when in Batch Mode, scan **Total Records**.



Delete Last Code

If you want to delete the last barcode scanned when in Batch Mode, scan **Delete Last Code**.



Clear All Codes

If you want to clear the scanner's buffer of all data accumulated in Batch Mode, scan **Clear All Codes**.



Transmit Records to Host

If you are operating in Inventory Batch Mode [Inventory Batch Mode](#), you must scan the following barcode to transmit all the stored data to the host system.



BAT_TX.

Transmit Inventory Records

Batch Mode Transmit Delay

Sometimes when accumulated scans are sent to the host system, the transmission of those scans is too fast for the application to process. To program a transmit delay between accumulated scans, scan one of the following delays. *Default = Off.*

Note: *In most cases, a short (250 ms (milliseconds)) delay is ideal, however, longer delays may be programmed. Contact [Customer Support](#) for additional information.*



BATDLY0.

*** Batch Mode Transmit Delay Off
(No Delay)**



BATDLY250.

**Batch Mode Transmit Delay Short
(250 ms)**



BATDLY500.

**Batch Mode Transmit Delay Medium
(500 ms)**



BATDLY1000.

**Batch Mode Transmit Delay Long
(1000 ms)**

Multiple Scanner Operation

Note: *Multiple Scanner Operation Mode allows you to link up to 3 scanners to one base or Access Point (if supported). You cannot join an 4th scanner until you unlink one of the 3 scanners or take a scanner out of range.*

To put the scanner in multiple scanner mode, scan the barcode below. Once you scan this barcode, the scanner is unlinked from the base or Access Point and must either be placed into the base, or you must scan the Access Point linking barcode in order to relink.



Scanner Name

You may assign a name to each scanner you are using for identification purposes. For example, you may want to have a unique identifier for a scanner that is receiving imaging commands sent from the base or Access Point.

The default name is in the format “ScannerName_Model_SN_XXXXXXXXXX” If you have more than one scanner linked to a base, and they all have the same name, the first scanner linked to the base receives commands. When renaming a series of scanners with identical names, unlink all except one of the scanners from the base.

Perform the rename operation using either the barcodes on [page 61](#), or by sending the serial command `:ScannerName:BT_NAMNewName`. where *ScannerName* is the current name of the scanner, and *NewName* is the new name for the scanner. If you wish to change the names of additional scanners, link them one at a time and repeat the `:ScannerName:BT_NAMNewName`. command for each scanner.

To rename scanners with sequential, numeric names, scan the barcodes below. Scan the **Reset** code after each name change and wait for the scanner to relink to the base or Access Point before scanning a barcode to rename the next scanner.





You may also scan the **Scanner Name** barcode below and scan a number for the scanner name. For example, if you wanted to name the linked scanner “312,” you would scan the barcode below, scan the **3**, **1**, and **2** barcodes on the [Programming Chart](#), then scan **Save**. Scan the **Reset** barcode and wait for the scanner to relink to the base.

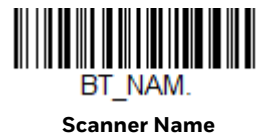

Application Work Groups

Your cordless system can have up to 3 scanners linked to one base or Access Point. You can also have up to 3 work groups. If you want to have all of the scanners’ settings programmed alike, you don’t need to use more than 1 work group. If you want each scanner to have unique settings (e.g., beeper volume, prefix/suffix, data format), then you may program each scanner to its own unique work group and may program each scanner independently. For example, you might want to have multiple work groups in a retail/warehouse application where you need to have different data appended to barcodes used in the warehouse area versus the retail area. You could assign all the scanners in the retail area to one work group and those in the warehouse to another. Consequently, any desired changes to either the retail or warehouse area would apply to all scanners in that particular work group. Honeywell’s online configuration tool, EZConfig for Scanning ([page 168](#)), makes it easy for you to program your system for use with multiple scanners and multiple work groups.

The scanner keeps a copy of the menu settings it is using. Whenever the scanner is connected or reconnected to a base or an Access Point, the scanner is updated with the latest settings from the base or Access Point for its work group. The scanner also receives menu setting changes processed by the base or Access Point. If a scanner is removed from a base or an Access Point and placed into another base or linked to another Access Point, it will be updated with the new base/Access Point settings for whatever work group to which that the scanner was previously assigned. For example, if the scanner was in work group 1 linked to the first base, it will be placed in work group 1 in the second base with the associated settings.

Application Work Group Selection

This programming selection allows you to assign a scanner to a work group by scanning the barcode below. You may then program the settings (e.g., beeper volume, prefix/suffix, data formatter) that your application requires. *Default = Group 0.*



GRPSEL0.
* Group 0



GRPSEL1.
Group 1



GRPSEL2.
Group 2



GRPSEL3.
Group 3



GRPSEL4.
Group 4



GRPSEL5.
Group 5



GRPSEL6.
Group 6

Reset the Factory Defaults: All Application Work Groups

The following barcode defaults all of the work groups to the factory default settings.



PAPDFT&
Factory Default Settings:
All Work Groups

To see what the factory default settings are, refer to the table of [Menu Commands](#), beginning on page 175. The standard product default settings for each of the commands are indicated by an asterisk (*).

Note: Scanning this barcode also causes both the scanner and the base or Access Point to perform a reset and become unlinked. The scanner must be placed in the base, or the Access Point linking barcode must be scanned to re-establish the link. Refer to [Scanner Modes](#) for additional information.

If your scanner is in multiple scanner mode, you will hear up to 30 seconds of beeping while all scanners are relinked to the base or Access Point and the settings are changed.

Reset the Custom Defaults: All Application Work Groups

If you want the custom default settings restored to all of the work groups, scan the **Custom Product Default Settings** barcode below. (If there are no custom defaults, it will reset the work groups to the factory defaults.) See [Set Custom Defaults](#) on page 1-8. for further information about custom defaults.



**Custom Default Settings:
All Work Groups**

Note: Scanning this barcode also causes both the scanner and the base or Access Point to perform a reset and become unlinked. The scanner must be placed in its base, or the Access Point linking barcode must be scanned to re-establish the link. Refer to [Scanner Modes](#) for additional information.

If your scanner is in multiple scanner mode, you will hear up to 30 seconds of beeping while all scanners are relinked to the base or Access Point and the settings are changed.

Use the Scanner with Bluetooth Devices

The scanner can be used either with the charge base, an Access Point, or with other Bluetooth devices. Those devices include personal computers, laptops, PDAs, and Honeywell mobility systems devices.

Bluetooth Secure Simple Pairing (SSP)

Secure Simple Pairing (SSP) allows you to connect simply and securely to other Bluetooth devices without having to enter a PIN code (as described in [Bluetooth HID Keyboard Connect](#) procedure). SSP is only available when using Bluetooth ver-

sion 2.1 or higher. When SSP is on, no PIN is required for pairing. Turn SSP off if you are connecting to a Bluetooth device that is not using a compatible Bluetooth version. *Default = Bluetooth SSP On.*



Bluetooth HID Keyboard Connect

Your scanner can be paired with Bluetooth-capable devices, such as personal computers, laptops, and tablets, so that scanned data appears on your device screen as though it was entered on the keyboard. In order to pair with the Bluetooth device:

1. Scan the appropriate **Bluetooth HID Keyboard Connect** barcode below.

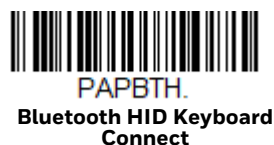

2. Set your personal computer, laptop, or tablet so it searches for other Bluetooth devices. (Refer to your device's User Guide for pairing instructions.)
3. Once your personal computer, laptop, or tablet has located the scanner, select the scanner name. Some personal computers, laptops, or tablets will automatically pair with the scanner. If your device automatically pairs with the scanner, it displays a successful pairing message and you do not need to continue to the next step.
4. If your personal computer, laptop, or tablet does not automatically pair with the scanner, a PIN is displayed. This PIN must be scanned within 60 seconds. You must quickly scan **Bluetooth PIN Code** below, then scan the numeric barcode(s) for the PIN code from the chart below, then scan the **Save** barcode.





Your personal computer, laptop, or tablet should now be paired with the scanner.

Once the scanner battery is charged and you have paired it, you may begin scanning barcodes. Verify the scanner operation by scanning a barcode from the [Sample Symbols](#) in the back of this manual.

Virtual Keyboard

Once your scanner has been connected directly to an iPad, smart phone, or laptop, you can toggle the virtual keyboard on your device with a quick double pull of the scanner trigger.

Bluetooth HID Keyboard Disconnect

If your scanner has been connected directly to an iPad, smart phone, or laptop using [Bluetooth HID Keyboard Connect](#), you must disconnect it in order to once again communicate with the base or Access Point. Scan the **Bluetooth HID Keyboard Disconnect** barcode to unlink the scanner from the currently linked host. Scan the linking barcode on the base or Access Point to relink the scanner.



PAPSPP.

Bluetooth HID Keyboard Disconnect

Bluetooth Serial Port - PCs/Laptops

Scanning the **Non-Base BT Connection** barcode below unlinks your scanner and puts it into a discoverable state. Once the scanner searches for and connects with a Bluetooth host, the scanner stores the connection to the host device address and switches virtual COM ports. This allows the scanner to automatically relink to the host if the connection is lost.



BT_TRM0,DNG5.

Non-Base BT Connection

PDAs/Mobility Systems Devices

You may also use the scanner with a PDA or a Honeywell Mobility Systems device. Scan the barcode below and follow the instructions supplied with your Bluetooth device to locate the scanner, and connect with it.



BT_TRM0;BT_DNG1.

BT Connection - PDA/Mobility Systems Device

Change the Scanner's Bluetooth PIN Code

Some devices require a PIN code as part of the Bluetooth security features. Your scanner's default PIN is **1234**, which you may need to enter the first time you connect to your PDA or PC. The PIN code must be between 1 and 16 characters. To change the PIN, scan the barcode below and then scan the appropriate numeric barcodes from the [Programming Chart](#). Scan **Save** to save your selection.



Minimize Bluetooth/ISM Band Network Activity

The settings described below can help you customize the relinking behavior of the cordless area-imaging system to obtain the best compromise between convenience and low interference.

Note: ISM band refers to the 2.4 to 2.48 GHz frequency band used by wireless networks, cordless phones, and Bluetooth.

Auto Reconnect Mode

Auto Reconnect controls whether or not the scanner automatically begins the relink process when a loss of connection is detected. When the **Auto Reconnect On** barcode is scanned, the scanner begins the relink process immediately, without user intervention. *Default = Auto Reconnect On.*



Note: If you are connecting to a Bluetooth Interface Module, set Auto Reconnect to Off.

The table below shows the results of the Auto Reconnect On and Off settings:

Event	Auto Reconnect On	Auto Reconnect Off
Scanner out of range	Relink occurs automatically. If maximum number of link attempts is unsuccessful, then the scanner must be relinked by either pulling the trigger, placing the scanner in the base, or scanning the Access Point linking barcode (see Maximum Link Attempts).	The scanner is relinked by pulling the trigger, or scanning the Access Point linking barcode.

Event	Auto Reconnect On	Auto Reconnect Off
Base or Access point reset (firmware upgrade or power cycle)	Scanner behaves as if out of range.	No attempt to relink made while base or Access Point is powered off. Trigger must be pulled to initiate relinking.
Scanner power down due to Scanner Power Time-Out Timer setting.	Trigger must be pulled, Access Point linking barcode must be scanned, or the scanner must be placed in the base unit to relink. (Note: scanner relinks on power up, but powers on due to one of the above actions.)	
Scanner reset due to firmware upgrade	Relink occurs automatically.	
Scanner reset due to battery change	Relink occurs automatically.	
Scanner placed in different base unit	Relink to new base occurs automatically.	

Maximum Link Attempts

The Maximum Link Attempts setting controls the number of times the scanner tries to form a connection with a base or an Access Point. During the connection setup process, the scanner transmits in order to search for and connect to a base or an Access Point. In order to prevent continuous transmissions that could interfere with other users of the ISM band, the number of attempts to connect is limited by this setting. After the maximum number of attempts is reached, the scanner will not attempt to reconnect to a base or an Access Point. Pressing the trigger, scanning an Access Point linking barcode, or placing the scanner in the cradle resets the attempt count and the scanner will again try to link.

Scan the **Maximum Link Attempts** barcode, then scan the number of attempts for the setting (from 0-100) from the [Programming Chart](#). Scan **Save** to save the setting. *Default = 0.*



Maximum Link Attempts

Note: When Auto Reconnect Mode is On, setting Maximum Link Attempts to zero will cause the scanner to try to link until the [Scanner Power Time-Out Timer](#) setting expires. When Auto Reconnect Mode is Off, setting Maximum Link Attempts to zero will cause the scanner to only attempt linking one time after a trigger pull.

Relink Time-Out

Relink Time-Out controls the idle time between relink attempts. An attempt to link a scanner to a base or an Access Point typically lasts up to 5 seconds. This is the time when the scanner is actually attempting a contact. Relink Time-Out controls the amount of time, in seconds, that elapses between the end of one connection attempt and the start of the next.

Note: *The length of time for an attempt depends on the number of scanners connected to a base unit or Access Point. An extra 7 seconds may be required when a connection is successful.*

Scan the **Relink Time-Out** barcode, then scan the number of seconds for the setting (from 1-100) from the [Programming Chart](#). Scan **Save** to save the setting. Default = 3 seconds.



BT_RLT.

Relink Time-Out

Bluetooth/ISM Network Activity Examples

Default values

When the scanner goes out of range, the scanner repeatedly attempts to connect to the base unit or Access Point. Each attempt consists of approximately 5 seconds of active time followed by 3 seconds of idle time. After one hour, the scanner powers off and batch mode data is lost.

Maximum Link Attempts set to 15

Other values at default setting

When the scanner goes out of range, 15 attempts are made to link to the base unit or Access Point. Each attempt consists of approximately 5 seconds of active time followed by 3 seconds of idle time. After 15 cycles ($8 \times 15 = 120$), or about 2 minutes, the scanner stops trying to connect to the base or Access Point, but retains any barcodes that may have been saved in batch mode. After one hour, the scanner powers off and batch mode data is lost.

Auto Reconnect Mode set to 0

Maximum Link Attempts set to 15

Other values at default setting

When the scanner goes out of range, no action is taken to relink. When the trigger is pulled, 15 attempts are made to link to the base or Access Point. Each attempt consists of approximately 5 seconds of active time followed by 3 seconds of idle time. After 15 cycles ($8 \times 15 = 120$), or about 2 minutes, the scanner stops trying to connect to the base or Access Point, but retains any barcodes that may have been saved in batch mode. After one hour, the scanner powers off and batch mode data is lost. Refer to [Auto Reconnect Mode](#), to review other events that can start the relink process.

Auto Reconnect Mode set to 1
Maximum Link Attempts set to 0
Relink Time-Out set to 10
Scanner Power Time-Out Timer set to 1800

Note: See [Scanner Power Time-Out Timer](#).

The scanner attempts to connect to the base or Access Point every 15 seconds, measured from one attempt start to the next attempt start. After one half hour, the scanner powers off.

Host Acknowledgment

Some applications require that the host terminal (or server) validate incoming barcode data (database look-up) and provide acknowledgment to the scanner whether or not to proceed. In Host ACK Mode, the scanner waits for this acknowledgment after each scan. Visual and audible acknowledgments provide valuable feedback to the scan operator. The Host ACK functionality is controlled via a number of predefined escape commands that are sent to the scanner to make it behave in different ways.

Note: *System performance degrades when using Host ACK at rates lower than 9600 baud.*

The following criteria must be met for the Host ACK to work correctly:

- The cordless system must be configured for Host Port RS232 (terminal ID = 000) or USB COM Emulation (terminal ID = 130).
- RTS/CTS is defaulted off. You must enable it if the host system requires it.
- Host ACK must be set to On ([page 71](#)).
- A comma must be used as a terminator.
- The host terminal software must be capable of interpreting the barcode data, make decisions based on the data content, and send out appropriate escape commands to the scanner.

Escape commands are addressed to the scanner via “Application Work Groups.” Once a command is sent, all scanners in a group respond to that command. Because of this, it is recommended that each scanner is assigned to its own group in Host ACK mode.

The commands to which the scanner responds are listed on [page 72](#). The [ESC] is a 1B in hex. A typical command string is y [ESC] x, where “y” is the application work group number, “[ESC] x” is the escape command, and the comma is the terminator, which is required. (When “y” is not specified, the command is sent to the default Application Work Group 0.)

Example: Commands may be strung together to create custom response sequences. An example of a command string is listed below.

```
0[ESC]4,[ESC]5,[ESC]6,
```

The above example will make a scanner that is in application work group zero beep low, then medium, then high.

Example: A good read beep is required for any item on file, but a razz or error tone is required if the item is not on file. In this case,

[ESC]7, is sent to the host for an on-file product

[ESC]8,[ESC]8, is sent to the host for a not-on-file product

When a barcode is scanned, the scanner enters a timeout period until either the host ACK sequence is received, or the timeout expires (in 10 seconds, by default).

Once Host ACK is enabled, the system works as follows when a barcode is scanned:

- The scanner reads the code and sends data to the base or Access Point to transmit to the host system. No audible or visual indication is emitted until the scanner receives an escape command. The scanner read illumination goes out when there's a successful read.
- Scanner operation is suspended until 1) a valid escape string is received from the host system or 2) the scanner times out.
- Once condition 1 or 2 above has been met, the scanner is ready to scan again, and the process repeats.

A timeout occurs if the scanner does not receive a valid escape command within the timeout period. A timeout is indicated by an error tone. If a timeout occurs, the operator should check the host system to understand why a response to the scanner was not received.

Host ACK On/Off



HSTACK1.
Host ACK On



HSTACK0.
* Host ACK Off

Host ACK Timeout

You can set a timeout for the length of time the scanner waits for a valid escape command when using Host Acknowledgment Mode. Set the length (in seconds) for a timeout by scanning the following barcode, then setting the timeout (from 1-90 seconds) by scanning digits from the [Programming Chart](#), then scanning **Save**.
Default = 10.



HSTATO.

Host ACK Timeout

Host ACK Responses

Command	Action
[ESC] a,	Double beeps to indicate a successful menu change was made.
[ESC] b,	Razz or error tone to indicate a menu change was unsuccessful.
[ESC] 1,	The green LED illuminates for 135 milliseconds followed by a pause.
[ESC] 2,	The green LED illuminates for 2 seconds followed by a pause.
[ESC] 3,	The green LED illuminates for 5 seconds followed by a pause.
[ESC] 4,	Emits a beep at a low pitch.
[ESC] 5,	Emits a beep at a medium pitch.
[ESC] 6,	Emits a beep at a high pitch.
[ESC] 7,	Beeps to indicate a successful decode and communication to host.
[ESC] 8,[ESC] 8,	Razz or error tone to indicate a decode/communication to host was unsuccessful.

Power Up Beeper

The scanner can be programmed to beep when it's powered up. If you are using a cordless system, the base can also be programmed to beep when it is powered up. Scan the **Off** barcode(s) if you don't want a power up beep. *Default = Power Up Beeper On - Scanner.*



BEPWR0.

Power Up Beeper Off -
Scanner



BASPWR0.

Power Up Beeper Off -
Cordless Base



BEPWR1.

* Power Up Beeper On -
Scanner



BASPWR1.

* Power Up Beeper On -
Cordless Base

Beep on BEL Character

You may wish to force the scanner to beep upon a command sent from the host. If you scan the **Beep on BEL On** barcode below, the scanner will beep every time a BEL character is received from the host. *Default = Beep on BEL Off.*



Trigger Click

To hear an audible click every time the scanner trigger is pressed, scan the **Trigger Click On** barcode below. Scan the **Trigger Click Off** code if you don't wish to hear the click. (This feature has no effect on serial or automatic triggering.) *Default = Trigger Click Off.*



Good Read and Error Indicators

Beeper – Good Read

The beeper may be programmed **On** or **Off** in response to a good read. Turning this option off, only turns off the beeper response to a good read indication. All error and menu beeps are still audible. *Default = Beeper - Good Read On.*



Beeper Volume – Good Read

The beeper volume codes modify the volume of the beep the scanner emits on a good read. *Default = High.*



BEPLVL1.
Low



BEPLVL2.
Medium



BEPLVL3.
* High



BEPLVL0.
Off

Beeper Pitch – Good Read

The beeper pitch codes modify the pitch (frequency) of the beep the scanner emits on a good read. *Default = Medium.*



BEPFQ11600.
Low (1600 Hz)



BEPFQ12400.
* Medium (2400 Hz)



BEPFQ14200.
High (4200 Hz)

Beeper Pitch – Error

The beeper pitch codes modify the pitch (frequency) of the sound the scanner emits when there is a bad read or error. *Default = Razz.*



BEPFQ2250.
* Razz (250 Hz)



Beeper Duration – Good Read

The beeper duration codes modify the length of the beep the scanner emits on a good read. *Default = Normal.*



LED – Good Read

The LED indicator can be programmed **On** or **Off** in response to a good read. *Default = On.*



Number of Beeps – Good Read

The number of beeps of a good read can be programmed from 1 - 9. The same number of beeps will be applied to the beeper and LED in response to a good read. For example, if you program this option to have five beeps, there will be five beeps and five LED flashes in response to a good read. The beeps and LED flashes are in

sync with one another. To change the number of beeps, scan the barcode below and then scan a digit (1-9) barcode and the **Save** barcode on the [Programming Chart](#). *Default = 1.*



Number of Good Read Beeps/LED Flashes

Number of Beeps – Error

The number of beeps and LED flashes emitted by the scanner for a bad read or error can be programmed from 1 - 9. For example, if you program this option to have five error beeps, there will be five error beeps and five LED flashes in response to an error. To change the number of error beeps, scan the barcode below and then scan a digit (1-9) barcode and the **Save** barcode on the [Programming Chart](#). *Default = 1.*



Number of Error Beeps/LED Flashes

Good Read Delay

This sets the minimum amount of time before the scanner can read another barcode. *Default = 0 ms (No Delay).*



*** No Delay**



Medium Delay (1,000 ms)



Short Delay (500 ms)



Long Delay (1,500 ms)

User-Specified Good Read Delay

If you want to set your own length for the good read delay, scan the barcode below, then set the delay (from 0-30,000 milliseconds) by scanning digits from the [Programming Chart](#), then scanning **Save**.



User-Specified Good Read Delay

Manual Trigger Mode

When in manual trigger mode, the scanner scans until a barcode is read, or until the trigger is released. *Default = Manual Trigger-Normal.*



*** Manual Trigger - Normal**

LED Illumination - Manual Trigger

If you wish to set the illumination LED brightness, scan one of the barcodes below. This sets the LED illumination for the scanner when the trigger is pressed. *Default = High.*

Note: *The LEDs are like a flash on a camera. The lower the ambient light in the room, the brighter the LEDs need to be so the scanner can “see” the barcodes*



Low



Medium



*** High**

Serial Trigger Mode

You can activate the scanner either by pressing the trigger, or using a serial trigger command (see [Trigger Commands](#) on page 174). When in serial mode, the scanner scans until a barcode has been read or until the deactivate command is sent. The scanner can also be set to turn itself off after a specified time has elapsed (see [Read Time-Out](#), which follows).

Read Time-Out

Use this selection to set a time-out (in milliseconds) of the scanner's trigger when using serial commands to trigger the scanner. Once the scanner has timed out, you can activate the scanner either by pressing the trigger or using a serial trigger command. After scanning the **Read Time-Out** barcode, set the time-out duration (from 0-300,000 milliseconds) by scanning digits on the [Programming Chart](#), then scanning **Save**. *Default = 30,000 ms.*



TRGSTO.

Read Time-Out

Presentation Mode

Presentation Mode uses ambient light to detect barcodes. The LED dims until a barcode is presented to the scanner, then the LED brightens to read the code. If the light level in the room is not high enough, Presentation Mode may not work properly.

Note: *If you are using a cordless charge base in Presentation Mode, the battery will not charge unless the power supply is plugged into the base's auxiliary power port.*

Scan the following barcode to program your scanner for Presentation Mode.



PAPPST.

Presentation Mode

Triggered Presentation Mode

This mode uses light to detect the presence of an object. *Default = Ambient and Scanner Light.*



PDCLEDO.

Ambient Light Only



*Ambient and Scanner Light

Presentation Centering

Use Presentation Centering to narrow the scanner's field of view when it is in the stand to make sure the scanner reads only those barcodes intended by the user. For instance, if multiple codes are placed closely together, Presentation Centering will insure that only the desired codes are read.

Note: To adjust centering when the scanner is hand-held, see [Centering](#).

If a barcode is not touched by a predefined window, it will not be decoded or output by the scanner. If Presentation Centering is turned on by scanning **Presentation Centering On**, the scanner only reads codes that pass through the centering window you specify using the **Top of Presentation Centering Window**, **Bottom of Presentation Centering Window**, **Left**, and **Right of Presentation Centering Window** barcodes.

In the example below, the white box is the centering window. The centering window has been set to 20% left, 30% right, 8% top, and 25% bottom. Since Barcode 1 passes through the centering window, it will be read. Barcode 2 does not pass through the centering window, so it will not be read.

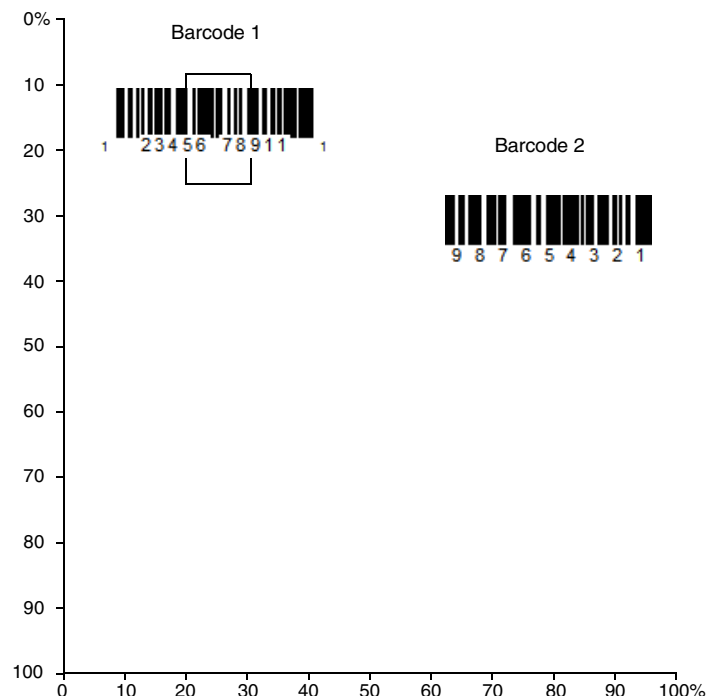

Note: A barcode needs only to be touched by the centering window in order to be read. It does not need to pass completely through the centering window.

Scan **Presentation Centering On**, then scan one of the following barcodes to change the top, bottom, left, or right of the centering window. Then scan the percent you want to shift the centering window using digits on the [Programming Chart](#). Scan **Save**. *Default Presentation Centering = 40% for Top and Left, 60% for Bottom and Right.*

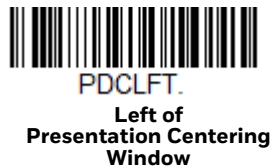

In-Stand Sensor Mode

This feature senses when the scanner is removed from the stand and tells it to begin manual triggering. When **Sensor On** is enabled, the scanner defaults to Presentation Mode when it is in the stand, and to Manual Trigger Mode when it is removed from the stand. *Default = Sensor On.*



Poor Quality Codes

Poor Quality 1D Codes

This setting improves the scanner's ability to read damaged or badly printed linear barcodes. When **Poor Quality 1D Reading On** is scanned, poor quality linear barcode reading is improved, but the scanner's snappiness is decreased, making it less aggressive when reading good quality barcodes. This setting does not affect 2D barcode reading. *Default = Poor Quality 1D Reading Off.*



DECLDI1.

Poor Quality 1D Reading On



DECLDI0.

*** Poor Quality 1D Reading Off**

Poor Quality PDF Codes

This setting improves the scanner's ability to read damaged or badly printed PDF codes by combining information from multiple images. It is useful when a complete barcode cannot be seen in one image. This setting does not affect 1D barcode reading. *Default = Poor Quality PDF Reading Off.*



PDFXPR10.

Poor Quality PDF Reading On



PDFXPR0.

*** Poor Quality PDF Reading Off**

CodeGate®

When CodeGate is **On**, the trigger is used to allow decoded data to be transmitted to the host system. The scanner remains on, scanning and decoding barcodes, but the barcode data is not transmitted until the trigger is pressed. When CodeGate is **Off**, barcode data is transmitted when it is decoded. *Default = CodeGate Off Out-of-Stand.*



Mobile Phone Read Mode

When this mode is selected, your scanner is optimized to read barcodes from mobile phone or other LED displays. However, the speed of scanning printed barcodes may be slightly lower when this mode is enabled



Hand Held Scanning - Mobile
Phone

Note: To turn off Mobile Phone Read Mode, scan the [Manual Trigger Mode](#) barcode.

Hands Free Time-Out

The Scan Stand and Presentation Modes are referred to as “hands free” modes. If the scanner’s trigger is pressed when using a hands free mode, the scanner changes to manual trigger mode. You can set the time the scanner should remain in manual trigger mode by setting the Hands Free Time-Out. Once the time-out value is reached, (if there have been no further trigger presses) the scanner reverts to the original hands free mode.

Scan the **Hands Free Time-Out** barcode, then scan the time-out duration (from 0-300,000 milliseconds) from the [Programming Chart](#), and **Save**. *Default = 5,000 ms.*



Hands Free Time-Out

Reread Delay

This sets the time period before the scanner can read the *same* barcode a second time. Setting a reread delay protects against accidental rereads of the same barcode. Longer delays are effective in minimizing accidental rereads. Use shorter delays in applications where repetitive barcode scanning is required. Reread Delay only works when in [Presentation Mode](#). *Default = Medium*.



User-Specified Reread Delay

If you want to set your own length for the reread delay, scan the barcode below, then set the delay (from 0-30,000 milliseconds) by scanning digits from the [Programming Chart](#), then scanning **Save**.



User-Specified Reread Delay

2D Reread Delay

Sometimes 2D barcodes can take longer to read than other barcodes. If you wish to set a separate Reread Delay for 2D barcodes, scan one of the programming codes that follows. **2D Reread Delay Off** indicates that the time set for [Reread Delay](#) is used for both 1D and 2D barcodes. *Default = 2D Reread Delay Off*.





DLY2RR2000.

Medium (2000ms)



DLY2RR1000.

Short (1000ms)



DLY2RR3000.

Long (3000ms)



DLY2RR4000.

Extra Long (4000ms)

Character Activation Mode

You may use a character sent from the host to trigger the scanner to begin scanning. When the activation character is received, the scanner continues scanning until either the [Character Activation Timeout](#), the deactivation character is received (see [Deactivation Character](#)), or a barcode is transmitted. Scan the following **On** barcode to use character activation, then use Activation Character (following) to select the character you will send from the host to start scanning. *Default = Off.*



HSTCEN0.

* Off



HSTCEN1.

On

Activation Character

This sets the character used to trigger scanning when using Character Activation Mode. On the [ASCII Conversion Chart \(Code Page 1252\)](#), find the hex value that represents the character you want to use to trigger scanning. Scan the following barcode, then use the [Programming Chart](#) to read the alphanumeric combination that represents that ASCII character. Scan **Save** to finish.



HSTACH.

Activation Character

End Character Activation After Good Read

After a barcode is successfully detected and read from the scanner, the aimer can be programmed either to remain on and scanning, or to turn off. When **End Character Activation After Good Read** is enabled, the aimer turns off and stops scanning after a good read. If you scan **Do Not End Character Activation After Good Read**, the aimer remains on after a good read. *Default = End Character Activation After Good Read.*



HSTCGD0.

**Do Not End Character
Activation After Good Read**



HSTCGD1.

*** End Character Activation
After Good Read**

Character Activation Timeout

You can set a timeout for the length of time the aimer remains on and attempting to decode barcodes when using [Character Activation Mode](#). Set the length (in milliseconds) for a timeout by scanning the following barcode, then setting the timeout (from 1-65535 milliseconds) by scanning digits from the [Programming Chart](#), then scanning **Save**. *Default = 5000 ms.*



HSTCDT.

Character Activation Timeout

Character Deactivation Mode

If you have sent a character from the host to trigger the scanner to begin scanning, you can also send a deactivation character to stop scanning. Scan the following **On** barcode to use character deactivation, then use [Deactivation Character](#) to select the character you will send from the host to terminate scanning. *Default = Off.*



HSTDEN0.

*** Off**



HSTDEN1.

On

Deactivation Character

This sets the character used to terminate scanning when using Character Deactivation Mode. On the [ASCII Conversion Chart \(Code Page 1252\)](#), find the hex value that represents the character you want to use to terminate scanning. Scan the following barcode, then use the [Programming Chart](#) to read the alphanumeric combination that represents that ASCII character. Scan **Save** to finish.



HSTDCH.

Deactivation Character

Illumination Lights

If you want the illumination lights on while reading a barcode, scan the **Lights On** barcode, below. However, if you want to turn just the lights off, scan the **Lights Off** barcode. *Default = Lights On.*

Note: This setting does not affect the aimer light. The aiming light can be set using [Aimer Mode](#)



SCNLED1.
* Lights On



SCNLED0.
Lights Off

Aimer Delay

The aimer delay allows a delay time for the operator to aim the scanner before the picture is taken. Use these codes to set the time between when the trigger is pulled and when the picture is taken. During the delay time, the aiming light will appear, but the LEDs won't turn on until the delay time is over. *Default = Off.*



SCNDLY200.
200 milliseconds



SCNDLY400.
400 milliseconds



SCNDLY0.
* Off (no delay)

User-Specified Aimer Delay

If you want to set your own length for the duration of the delay, scan the barcode below, then set the time-out by scanning digits (0 - 4,000 ms) from the [Programming Chart](#), then scan **Save**.



SCNDLY.
Delay Duration

Aimer Mode

This feature allows you to turn the aimer so that it is always on, always off, or in pulse mode. Pulse mode provides the best scan performance. **Always On** mode turns the aimer On while taking a picture. **Pulse Mode** turns the aimer Off while taking a picture and pulses the aimer when not taking a picture.

Default = Pulse Mode.



SCNAIM0.
Always Off



SCNAIM3.
Always On



SCNAIM5
*Pulse Mode

Centering

Use Centering to narrow the scanner's field of view to make sure that when the scanner is hand-held, it reads only those barcodes intended by the user. For instance, if multiple codes are placed closely together, centering will insure that only the desired codes are read.

Note: To adjust centering when the scanner is in the stand, see [Presentation Centering](#) (page 4-80).

If a barcode is not touched by a predefined window, it will not be decoded or output by the scanner. If centering is turned on by scanning **Centering On**, the scanner only reads codes that pass through the centering window you specify using the **Top of Centering Window**, **Bottom of Centering Window**, **Left**, and **Right of Centering Window** barcodes.

In the example below, the white box is the centering window. The centering window has been set to 20% left, 30% right, 8% top, and 25% bottom. Since Barcode 1 passes through the centering window, it will be read. Barcode 2 does not pass through the centering window, so it will not be read.

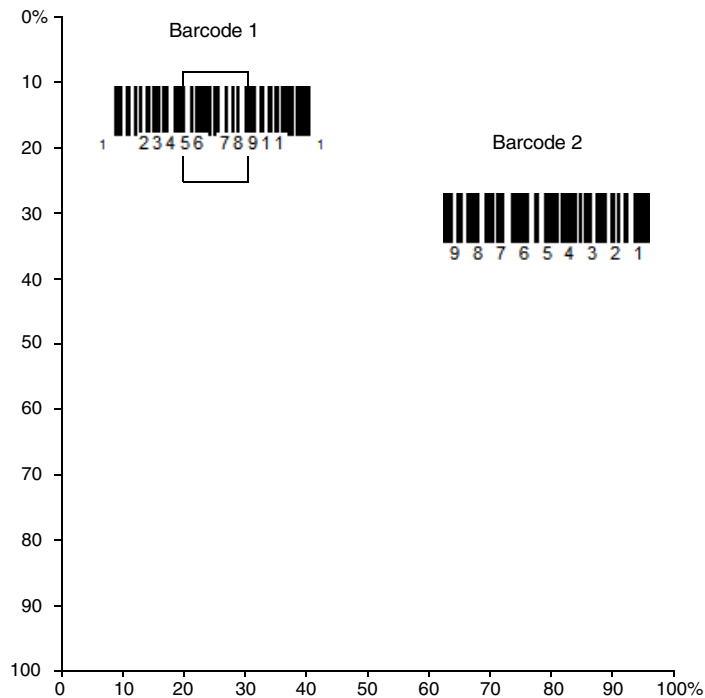

Note: A barcode needs only to be touched by the centering window in order to be read. It does not need to pass completely through the centering window.

Scan **Centering On**, then scan one of the following barcodes to change the top, bottom, left, or right of the centering window. Then scan the percent you want to shift the centering window using digits on the [Programming Chart](#). Scan **Save**. Default Centering = 40% for Top and Left, 60% for Bottom and Right.





No Read

With No Read turned On, the scanner notifies you if a code cannot be read. If using an EZConfig for Scanning Tool Scan Data Window (see page 168), an “NR” appears when a code cannot be read. If No Read is turned Off, the “NR” will not appear.
Default = Off.



If you want a different notation than “NR,” for example, “Error,” or “Bad Code,” you can edit the output message (see [Data Format](#)). The hex code for the No Read symbol is **9C**.

Video Reverse

Video Reverse is used to allow the scanner to read barcodes that are inverted. The **Video Reverse Off** barcode below is an example of this type of barcode. Scan **Video Reverse Only** to read *only* inverted barcodes. Scan **Video Reverse and Standard Barcodes** to read both types of codes.

Note: After scanning **Video Reverse Only**, menu barcodes cannot be read. You must scan **Video Reverse Off** or **Video Reverse and Standard Barcodes** in order to read menu barcodes.

Note: Images downloaded from the unit are not reversed. This is a setting for decoding only.



VIDREV1.

Video Reverse Only



VIDREV2.

Video Reverse and Standard Barcodes



VIDREV0.

*** Video Reverse Off**

Working Orientation

Some barcodes are direction-sensitive. For example, KIX codes can misread when scanned sideways or upside down. Use the working orientation settings if your direction-sensitive codes will not usually be presented upright to the scanner.
Default = Upright.

Upright:



Upside Down:



**Vertical, Top to Bottom:
(Rotate CW 90°)**

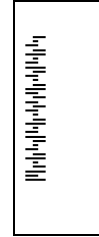

**Vertical, Bottom to Top:
(Rotate CCW 90°)**



ROTATN0.
* Upright



ROTATN2.
Upside Down



ROTATN1.
Vertical, Bottom to Top



ROTATN3.
Vertical, Top to Bottom

Prefix/Suffix Overview

When a barcode is scanned, additional information is sent to the host computer along with the barcode data. This group of barcode data and additional, user-defined data is called a “message string.” The selections in this section are used to build the user-defined data into the message string.

Prefix and Suffix characters are data characters that can be sent before and after scanned data. You can specify if they should be sent with all symbologies, or only with specific symbologies. The following illustration shows the breakdown of a message string:

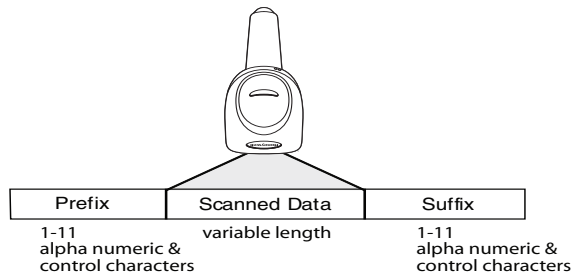

Points to Keep In Mind

- It is not necessary to build a message string. The selections in this chapter are only used if you wish to alter the default settings. *Default prefix = None. Default suffix = None.*
- A prefix or suffix may be added or cleared from one symbology or all symbologies.
- You can add any prefix or suffix from the [ASCII Conversion Chart \(Code Page 1252\)](#), plus Code I.D. and AIM I.D.
- You can string together several entries for several symbologies at one time.
- Enter prefixes and suffixes in the order in which you want them to appear on the output.

- When setting up for specific symbologies (as opposed to all symbologies), the specific symbology ID value counts as an added prefix or suffix character.
- The maximum size of a prefix or suffix configuration is 200 characters, which includes header information.

To Add a Prefix or Suffix:

- Step 1. Scan the **Add Prefix** or **Add Suffix** symbol ([page 95](#)).
- Step 2. Determine the 2 digit Hex value from the Symbology Chart (included in the [Symbology Charts](#)) for the symbology to which you want to apply the prefix or suffix. For example, for Code 128, Code ID is “j” and Hex ID is “6A”.
- Step 3. Scan the 2 hex digits from the [Programming Chart](#) or scan **9, 9** for all symbologies.

To add the Code I.D., scan **5, C, 8, 0**.

To add the AIM I.D., scan **5, C, 8, 1**.

To add the serial number, scan **5, C, 8, 8**.

To add a backslash (\), scan **5, C, 5, C**.

Note: *When adding a backslash (\), you must scan 5C twice – once to create the leading backslash and then to create the backslash itself.*

- Step 4. Repeat Steps 2 and 3 for every prefix or suffix character.
- Step 5. Scan **Save** to exit and save, or scan **Discard** to exit without saving.

Repeat the steps above to add a prefix or suffix for another symbology.

Example: Add a Tab Suffix to All Symbologies

- Step 1. Scan **Add Suffix**.
- Step 2. Scan **9, 9** from the [Programming Chart](#) to apply this suffix to all symbologies.
- Step 3. Scan **0, 9** from the [Programming Chart](#). This corresponds with the hex value for a horizontal tab, shown in the [ASCII Conversion Chart \(Code Page 1252\)](#), beginning on page 216.
- Step 4. Scan **Save**, or scan **Discard** to exit without saving.

Clear One or All Prefixes or Suffixes

You can clear a single prefix or suffix, or clear all prefixes/suffixes for a symbology. If you have been entering prefixes and suffixes for single symbologies, you can use **Clear One Prefix (Suffix)** to delete a specific character from a symbology. When you **Clear All Prefixes (Suffixes)**, all the prefixes or suffixes for a symbology are deleted.

- Step 1. Scan the **Clear One Prefix** or **Clear One Suffix** symbol.
- Step 2. Determine the 2 digit Hex value from the [Symbology Charts](#) for the symbology from which you want to clear the prefix or suffix.
- Step 3. Scan the 2 digit hex value from the [Programming Chart](#) or scan **9, 9** for all symbologies.

Your change is automatically saved.

Add a Carriage Return Suffix to All Symbologies

Scan the following barcode if you wish to add a carriage return suffix to all symbologies at once. This action first clears all current suffixes, then programs a carriage return suffix for all symbologies.



Prefix Selections



Suffix Selections

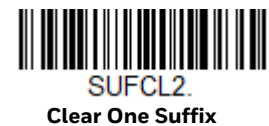



Function Code Transmit

When this selection is enabled and function codes are contained within the scanned data, the scanner transmits the function code to the terminal. Charts of these function codes are provided in the [ASCII Conversion Chart \(Code Page 1252\)](#). When the scanner is in keyboard wedge mode, the scan code is converted to a key code before it is transmitted. *Default = Enable.*



Intercharacter, Interfunction, and Intermessage Delays

Some terminals drop information (characters) if data comes through too quickly. Intercharacter, interfunction, and intermessage delays slow the transmission of data, increasing data integrity.

Intercharacter Delay

An intercharacter delay of up to 5000 milliseconds (in 5ms increments) may be placed between the transmission of each character of scanned data. Scan the **Intercharacter Delay** barcode below, then scan the number of 5ms delays, and the **Save** barcode using the [Programming Chart](#).

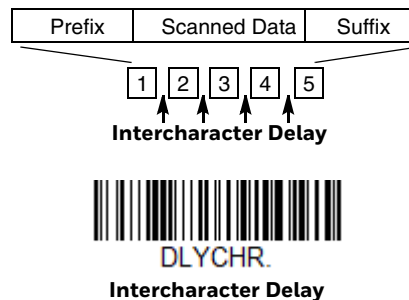

To remove this delay, scan the Intercharacter Delay barcode, then set the number of delays to **0**. Scan the **Save** barcode using the [Programming Chart](#).

Note: *Intercharacter delays are not supported in USB serial emulation.*

User Specified Intercharacter Delay

An intercharacter delay of up to 5000 milliseconds (in 5ms increments) may be placed after the transmission of a particular character of scanned data. Scan the **Delay Length** barcode below, then scan the number of 5ms delays, and the **Save** barcode using the [Programming Chart](#).

Next, scan the **Character to Trigger Delay** barcode, then the 2-digit hex value for a printable character to trigger the delay See [ISO 2022/ISO 646 Character Replacements](#) on page A-220..



To remove this delay, scan the **Delay Length** barcode, and set the number of delays to **0**. Scan the **Save** barcode using the [Programming Chart](#).

Interfunction Delay

An interfunction delay of up to 5000 milliseconds (in 5ms increments) may be placed between the transmission of each segment of the message string. Scan the **Interfunction Delay** barcode below, then scan the number of 5ms delays, and the **Save** barcode using the [Programming Chart](#).

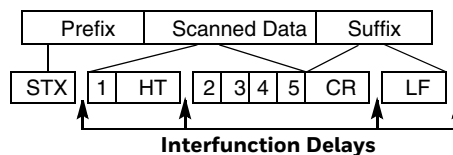

To remove this delay, scan the **Interfunction Delay** barcode, then set the number of delays to **0**. Scan the **Save** barcode using the [Programming Chart](#).

Intermessage Delay

An intermessage delay of up to 5000 milliseconds (in 5ms increments) may be placed between each scan transmission. Scan the **Intermessage Delay** barcode below, then scan the number of 5ms delays, and the **Save** barcode using the [Programming Chart](#).

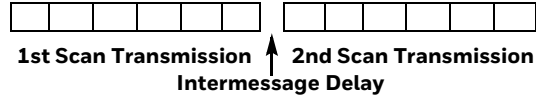

DLYMSG.
Intermessage Delay

To remove this delay, scan the **Intermessage Delay** barcode, then set the number of delays to **0**. Scan the **Save** barcode using the [Programming Chart](#).

Data Format Editor Introduction

You may use the Data Format Editor to change the scanner's output. For example, you can use the Data Format Editor to insert characters at certain points in barcode data as it is scanned. The selections in the following pages are used only if you wish to alter the output. *Default Data Format setting = None.*

Normally, when you scan a barcode, it gets outputted automatically; however when you create a format, you must use a "send" command [Send Commands](#) within the format program to output data.

Multiple formats may be programmed into the scanner. They are stacked in the order in which they are entered. However, the following list presents the order in which formats are applied:

1. Specific Terminal ID, Actual Code ID, Actual Length
2. Specific Terminal ID, Actual Code ID, Universal Length
3. Specific Terminal ID, Universal Code ID, Actual Length
4. Specific Terminal ID, Universal Code ID, Universal Length
5. Universal Terminal ID, Actual Code ID, Actual Length
6. Universal Terminal ID, Actual Code ID, Universal Length
7. Universal Terminal ID, Universal Code ID, Actual Length
8. Universal Terminal ID, Universal Code ID, Universal Length

The maximum size of a data format configuration is 2000 bytes, which includes header information.

If you have changed data format settings, and wish to clear all formats and return to the factory defaults, scan the **Default Data Format** code below.



DFMDF3.

* Default Data Format

Show Data Format

Scan the barcode below to show current data format settings.



DFMBK3?

Data Format Settings

Add a Data Format

- Step 1. Scan the [Enter Data Format](#) symbol.
- Step 2. Select **Primary/Alternate** Format
Determine if this will be your primary data format, or one of 3 alternate formats. This allows you to save a total of 4 different data formats. To program your primary format, scan **0** using the [Programming Chart](#). If you are programming an alternate format, scan **1**, **2**, or **3**, depending on which alternate format you are programming. (See [Primary/Alternate Data Formats](#) for further information.)
- Step 3. **Terminal Type**
Refer to [Terminal ID Table](#) and locate the Terminal ID number for your PC. Scan three numeric barcodes on the [Programming Chart](#) to program the scanner for your terminal ID (you must enter 3 digits). For example, scan **0 0 3** for an AT wedge.

Note: **099** indicates all terminal types.

- Step 4. **Code I.D.**
In the [Symbology Charts](#), find the symbology to which you want to apply the data format. Locate the Hex value for that symbology and scan the 2 digit hex value from the [Programming Chart](#).

Note: If you are creating a data format for Batch Mode Quantity, use **35** for the Code I.D.

- Step 5. **Length**
Specify what length (up to 9999 characters) of data will be acceptable for this symbology. Scan the four digit data length from the [Programming Chart](#). (Note: 50 characters is entered as 0050. 9999 is a universal number, indicating all lengths.)

Note: **9999** indicates all lengths.

- Step 6. **Editor Commands**
Refer to [Data Format Editor Commands](#). Scan the symbols that represent the command you want to enter.
- Step 7. Scan **Save** to save your data format, or **Discard** to exit without saving your changes.



DFMBK3.

Enter Data Format



Other Programming Selections

- **Clear One Data Format**
This deletes one data format for one symbology. If you are clearing the primary format, scan **0** from the [Programming Chart](#). If you are clearing an alternate format, scan **1**, **2**, or **3**, depending on the format you are clearing. Scan the Terminal Type and Code I.D. (see [Symbology Charts](#)), and the barcode data length for the specific data format that you want to delete. All other formats remain unaffected.
- **Clear all Data Formats**
This clears all data formats.
- **Save** to exit and save your data format changes.
- **Discard** to exit without saving any data format changes.



Terminal ID Table

Terminal	Model(s)	Terminal ID
USB	PC keyboard (HID)	124
	Mac Keyboard	125
	PC Keyboard (Japanese)	134
	Serial (COM driver required)	130
	HID POS	131
	USB SurePOS Handheld	128
	USB SurePOS Tabletop	129
Serial	RS232 TTL	000
	RS232 True	000
Keyboard	PS2 compatibles	003

Data Format Editor Commands

When working with the Data Format Editor, a virtual cursor is moved along your input data string. The following commands are used to both move this cursor to different positions, and to select, replace, and insert data into the final output.

Send Commands

Send all characters

- F1** Include in the output message all of the characters from the input message, starting from current cursor position, followed by an insert character. *Syntax = F1xx* where xx stands for the insert character's hex value for its ASCII code. Refer to the [ASCII Conversion Chart \(Code Page 1252\)](#) for decimal, hex and character codes.

Send a number of characters

- F2** Include in the output message a number of characters followed by an insert character. Start from the current cursor position and continue for "nn" characters or through the last character in the input message, followed by character "xx." *Syntax = F2nnxx* where nn stands for the numeric value (00-99) for the number of characters, and xx stands for the insert character's hex value for its ASCII code. Refer to the [ASCII Conversion Chart \(Code Page 1252\)](#), beginning on page 216 for decimal, hex and character codes.

F2 Example: Send a number of characters



Send the first 10 characters from the barcode above, followed by a carriage return.
Command string: F2100D

F2 is the “Send a number of characters” command

10 is the number of characters to send

0D is the hex value for a CR

The data is output as: **1234567890**

F2 and F1 Example: Split characters into 2 lines

Send the first 10 characters from the barcode above, followed by a carriage return, followed by the rest of the characters.

Command string: **F2100DF10D**

F2 is the “Send a number of characters” command

10 is the number of characters to send for the first line

0D is the hex value for a CR

F1 is the “Send all characters” command

0D is the hex value for a CR

The data is output as:

1234567890

ABCDEFGHIJ

<CR>

Send all characters up to a particular character

F3 Include in the output message all characters from the input message, starting with the character at the current cursor position and continuing to, but not including, the search character “ss,” followed by an insert character. The cursor is moved forward to the “ss” character. *Syntax = F3ssxx* where ss stands for the search character’s hex value for its ASCII code, and xx stands for the insert character’s hex value for its ASCII code.

Refer to the [ASCII Conversion Chart \(Code Page 1252\)](#) for decimal, hex and character codes.

F3 Example: Send all characters up to a particular character



Using the barcode above, send all characters up to but not including “D,” followed by a carriage return.

Command string: **F3440D**

F3 is the “Send all characters up to a particular character” command

44 is the hex value for a 'D’

0D is the hex value for a CR

The data is output as:

1234567890ABC

<CR>

Send all but the last characters

E9 Include in the output message all but the last “nn” characters, starting from the current cursor position. The cursor is moved forward to one position past the last input message character included. *Syntax = E9nn* where nn stands for the numeric value (00-99) for the number of characters that will not be sent at the end of the message.

Insert a character multiple times

F4 Send “xx” character “nn” times in the output message, leaving the cursor in the current position. *Syntax = F4xxnn* where xx stands for the insert character’s hex value for its ASCII code, and nn is the numeric value (00-99) for the number of times it should be sent.

Refer to the [ASCII Conversion Chart \(Code Page 1252\)](#), beginning on page 216 for decimal, hex and character codes.

E9 and F4 Example: Send all but the last characters, followed by 2 tabs



1234567890ABCDEFGHIJ

Send all characters except for the last 8 from the barcode above, followed by 2 tabs.

Command string: **E908F40902**

E9 is the “Send all but the last characters” command

08 is the number of characters at the end to ignore

F4 is the “Insert a character multiple times” command

09 is the hex value for a horizontal tab

02 is the number of times the tab character is sent

The data is output as: **1234567890AB <tab><tab>**

Move Commands

Move the cursor forward a number of characters

F5 Move the cursor ahead “nn” characters from current cursor position.
Syntax = F5nn where nn is the numeric value (00-99) for the number of characters the cursor should be moved ahead.

F5 Example: Move the cursor forward and send the data



Move the cursor forward 3 characters, then send the rest of the barcode data from the barcode above. End with a carriage return.

Command string: **F503F10D**

F5 is the “Move the cursor forward a number of characters” command

03 is the number of characters to move the cursor

F1 is the “Send all characters” command

0D is the hex value for a CR

The data is output as:

4567890ABCDEFGHIJ

<CR>

Move the cursor backward a number of characters

F6 Move the cursor back “nn” characters from current cursor position.
Syntax = F6nn where nn is the numeric value (00-99) for the number of characters the cursor should be moved back.

Move the cursor to the beginning

F7 Move the cursor to the first character in the input message. *Syntax = F7.*

FE and F7 Example: Manipulate barcodes that begin with a 1



Search for barcodes that begin with a 1. If a barcode matches, move the cursor back to the beginning of the data and send 6 characters followed by a carriage return. Using the barcode above:

Command string: **FE31F7F2060D**

FE is the “Compare characters” command

31 is the hex value for 1

F7 is the “Move the cursor to the beginning” command

F2 is the “Send a number of characters” command

06 is the number of characters to send

0D is the hex value for a CR

The data is output as:

123456

<CR>

Move the cursor to the end

EA Move the cursor to the last character in the input message. *Syntax = EA.*

Search Commands

Search forward for a character

F8 Search the input message forward for “xx” character from the current cursor position, leaving the cursor pointing to the “xx” character. *Syntax = F8xx* where xx stands for the search character’s hex value for its ASCII code. Refer to the [ASCII Conversion Chart \(Code Page 1252\)](#), beginning on page 216 for decimal, hex and character codes.

F8 Example: Send barcode data that starts after a particular character



Search for the letter “D” in barcodes and send all the data that follows, including the “D.” Using the barcode above:

Command string: **F844F10D**

F8 is the “Search forward for a character” command

44 is the hex value for “D”

F1 is the “Send all characters” command

0D is the hex value for a CR

The data is output as:

DEFGHIJ

<CR>

Search backward for a character

- F9** Search the input message backward for “xx” character from the current cursor position, leaving the cursor pointing to the “xx” character. *Syntax = F9xx* where xx stands for the search character’s hex value for its ASCII code. Refer to the [ASCII Conversion Chart \(Code Page 1252\)](#), beginning on page 216 for decimal, hex and character codes.

Search forward for a non-matching character

- E6** Search the input message forward for the first non-“xx” character from the current cursor position, leaving the cursor pointing to the non-“xx” character. *Syntax = E6xx* where xx stands for the search character’s hex value for its ASCII code. Refer to the [ASCII Conversion Chart \(Code Page 1252\)](#), beginning on page 216 for decimal, hex and character codes.

E6 Example: Remove zeros at the beginning of barcode data



This example shows a barcode that has been zero filled. You may want to ignore the zeroes and send all the data that follows. E6 searches forward for the first character that is not zero, then sends all the data after, followed by a carriage return. Using the barcode above:

Command string: **E630F10D**

E6 is the “Search forward for a non-matching character” command

30 is the hex value for 0

F1 is the “Send all characters” command

0D is the hex value for a CR

The data is output as:

37692
<CR>

Search backward for a non-matching character

- E7** Search the input message backward for the first non-“xx” character from the current cursor position, leaving the cursor pointing to the non-“xx” character. *Syntax = E7xx* where xx stands for the search character’s hex value for its ASCII code. Refer to the [ASCII Conversion Chart \(Code Page 1252\)](#), beginning on page 216 for decimal, hex and character codes.

Miscellaneous Commands

Suppress characters

FB Suppress all occurrences of up to 15 different characters, starting at the current cursor position, as the cursor is advanced by other commands. When the FC command is encountered, the suppress function is terminated. The cursor is not moved by the FB command.

Syntax = FBnnxxyy ..zz where nn is a count of the number of suppressed characters in the list, and xxyy .. zz is the list of characters to be suppressed.

FB Example: Remove spaces in barcode data



This example shows a barcode that has spaces in the data. You may want to remove the spaces before sending the data. Using the barcode above:

Command string: **FB0120F10D**

FB is the “Suppress characters” command

01 is the number of character types to be suppressed

20 is the hex value for a space

F1 is the “Send all characters” command

0D is the hex value for a CR

The data is output as:

34567890

<CR>

Stop suppressing characters

FC Disables suppress filter and clear all suppressed characters. Syntax = FC.

Replace characters

E4 Replaces up to 15 characters in the output message, without moving the cursor. Replacement continues until the E5 command is encountered. Syntax = E4nnxx₁xx₂yy₁yy₂...zz₁zz₂ where nn is the total count of the number of characters in the list (characters to be replaced plus replacement characters); xx₁ defines characters to be replaced and xx₂ defines replacement characters, continuing through zz₁ and zz₂.

E4 Example: Replace zeros with CRs in barcode data



If the barcode has characters that the host application does not want included, you can use the E4 command to replace those characters with something else. In this example, you will replace the zeroes in the barcode above with carriage returns.

Command string: **E402300DF10D**

E4 is the “Replace characters” command

02 is the total count of characters to be replaced, plus the replacement characters (0 is replaced by CR, so total characters = 2)

30 is the hex value for 0

0D is the hex value for a CR (the character that will replace the 0)

F1 is the “Send all characters” command

0D is the hex value for a CR

The data is output as:

1234

5678

ABC

<CR>

Stop replacing characters

E5 Terminates character replacement. *Syntax = E5.*

Compare characters

FE Compare the character in the current cursor position to the character “xx.” If characters are equal, move the cursor forward one position. *Syntax = FExx* where xx stands for the comparison character’s hex value for its ASCII code.

Refer to the [ASCII Conversion Chart \(Code Page 1252\)](#), beginning on page 216 for decimal, hex and character codes.

Check for a number

EC Check to make sure there is an ASCII number at the current cursor position. The format is aborted if the character is not numeric.

EC Example: Only output the data if the barcode begins with a number

If you want only data from barcodes that begin with a number, you can use EC to check for the number.

Command string: **ECF10D**

EC is the “Check for a number” command

F1 is the “Send all characters” command

0D is the hex value for a CR

If this barcode is read,  the next data format, if there is one, will be used on the data. If there is no other format, the format fails and the raw data is output as **AB1234**.

If this barcode is read:  the data is output as:

1234AB
<CR>

Check for non-numeric character

ED Check to make sure there is a non-numeric ASCII character at the current cursor position. The format is aborted if the character is numeric.

ED Example: Only output the data if the barcode begins with a letter

If you want only data from barcodes that begin with a letter, you can use ED to check for the letter.

Command string: **EDF10D**

ED is the “Check for a non-numeric character” command

F1 is the “Send all characters” command

0D is the hex value for a CR

If this barcode is read,  the next data format, if there is one, will be used on this data. If there is no other format, the format fails and the raw data is output as **1234AB**.

If this barcode is read:  the data is output as:

AB1234
<CR>

Insert a delay

EF Inserts a delay of up to 49,995 milliseconds (in multiples of 5), starting from the current cursor position. Syntax = EFnnnn where nnnn stands for the delay in 5ms increments, up to 9999. This command can only be used with keyboard emulation.

Data Formatter

When Data Formatter is turned **Off**, the barcode data is output to the host as read, including prefixes and suffixes.



You may wish to require the data to conform to a data format you have created and saved. The following settings can be applied to your data format:

- **Data Formatter On, Not Required, Keep Prefix/Suffix**
Scanned data is modified according to your data format, and prefixes and suffixes are transmitted.
- **Data Format Required, Keep Prefix/Suffix**
Scanned data is modified according to your data format, and prefixes and suffixes are transmitted. Any data that does not match your data format requirements generates an error tone and the data in that barcode is not transmitted.

Default = Data Formatter On, Not Required, Keep Prefix/Suffix.



Primary/Alternate Data Formats

You can save up to four data formats, and switch between these formats. Your primary data format is saved under **0**. Your other three formats are saved under **1**, **2**, and **3**. To set your device to use one of these formats, scan one of the barcodes below.





ALTFNM2.
Data Format 2



ALTFNM1.
Data Format 1



ALTFNM3.
Data Format 3

SYMBOLOLOGIES

This programming section contains the following menu selections. Refer to [Chapter 9](#) for settings and defaults.

- All Symbolologies
- Aztec Code
- China Post (Hong Kong 2 of 5)
- Chinese Sensible (Han Xin) Code
- Codabar
- Codablock A
- Codablock F
- Code 11
- Code 128
- Code 32 Pharmaceutical (PARAF)
- Code 39
- Code 93
- Data Matrix
- EAN/JAN-13
- EAN/JAN-8
- GS1 Composite Codes
- GS1 DataBar Expanded
- GS1 DataBar Limited
- GS1 DataBar Omnidirectional
- GS1 Emulation
- GS1-128
- Interleaved 2 of 5
- Korea Post On/Off
- Matrix 2 of 5
- MaxiCode
- MicroPDF417
- MSI
- NEC 2 of 5
- Postal Codes - 2D
- Postal Codes - Linear
- PDF417
- GS1 DataBar Omnidirectional
- QR Code
- Straight 2 of 5 IATA (two-bar start/stop)
- Straight 2 of 5 Industrial (three-bar start/stop)
- TCIF Linked Code 39 (TLC39)
- UPC-A
- UPC-A/EAN-13 with Extended Coupon Code
- UPC-E0
- UPC-E1

All Symbologies

For best scanner performance, we recommend you only enable the symbologies that you need. Scan **All Symbologies Off** to disable all symbologies, then enable the symbologies you need by scanning the **On** barcode for each symbology.



ALLENA0.

All Symbologies Off

If you want to decode all the symbologies allowable for your scanner, scan the *All Symbologies On* code. If on the other hand, you want to decode only a particular symbology, scan All Symbologies Off followed by the On symbol for that particular symbology.

Note: *All Symbologies On should only be used when needed (or you are instructed to do so) and may result in slower performance.*



ALLENA1.

All Symbologies On



ALLENA0.

All Symbologies Off

Note: *When All Symbologies On is scanned, 2D Postal Codes are not enabled. 2D Postal Codes must be enabled separately.*

Message Length Description

You are able to set the valid reading length of some of the barcode symbologies. You may wish to set the same value for minimum and maximum length to force the scanner to read fixed length barcode data. This helps reduce the chances of a mis-read.

Example: Decode only those barcodes with a count of 9-20 characters.
Min. length = 09Max. length = 20

Example: Decode only those barcodes with a count of 15 characters.
Min. length = 15Max. length = 15

For a value other than the minimum and maximum message length defaults, scan the barcode included in the explanation of the symbology, then scan the digit value of the message length and **Save** barcodes on the [Programming Chart](#). The minimum and maximum lengths and the defaults are included with the respective symbologies.

Codabar

<Default All Codabar Settings>



Codabar On/Off



Codabar Start / Stop Characters

Start/Stop characters identify the leading and trailing ends of the barcode. You may either transmit, or not transmit Start/Stop characters. *Default = Don't Transmit.*



Codabar Check Character

Codabar check characters are created using different “modulos.” You can program the scanner to read only Codabar barcodes with Modulo 16 check characters. *Default = No Check Character.*

No Check Character indicates that the scanner reads and transmits barcode data with or without a check character.

When Check Character is set to **Validate and Transmit**, the scanner will only read Codabar barcodes printed with a check character, and will transmit this character at the end of the scanned data.

When Check Character is set to **Validate, but Don't Transmit**, the unit will only read Codabar barcodes printed *with* a check character, but will not transmit the check character with the scanned data.



Codabar Concatenation

Codabar supports symbol concatenation. When you enable concatenation, the scanner looks for a Codabar symbol having a “D” start character, adjacent to a symbol having a “D” stop character. In this case the two messages are concatenated into one with the “D” characters omitted.



Select **Require** to prevent the scanner from decoding a single “D” Codabar symbol without its companion. This selection has no effect on Codabar symbols without Stop/Start D characters.



Codabar Message Length

Scan the barcodes below to change the message length. Refer to [Message Length Description](#) (page 114) for additional information. Minimum and Maximum lengths = 2-60. Minimum Default = 4, Maximum Default = 60.



CBRMIN.

Minimum Message Length



CBRMAX.

Maximum Message Length

Code 39

< Default All Code 39 Settings >



C39DFT.

Code 39 On/Off



C39ENA1.

* On



C39ENA0.

Off

Code 39 Start/Stop Characters

Start/Stop characters identify the leading and trailing ends of the barcode. You may either transmit, or not transmit Start/Stop characters. *Default = Don't Transmit.*



C39SSX1.

Transmit



C39SSX0.
* Don't Transmit

Code 39 Check Character

No Check Character indicates that the scanner reads and transmits barcode data with or without a check character.

When Check Character is set to **Validate, but Don't Transmit**, the unit only reads Code 39 barcodes printed with a check character, but will not transmit the check character with the scanned data.

When Check Character is set to **Validate and Transmit**, the scanner only reads Code 39 barcodes printed with a check character, and will transmit this character at the end of the scanned data. *Default = No Check Character.*



C39CK20.
* No Check Character



C39CK21.
Validate, but Don't Transmit



C39CK22.
Validate and Transmit

Code 39 Message Length

Scan the barcodes below to change the message length. Refer to [Message Length Description](#) (page 114) for additional information. Minimum and Maximum lengths = 0-48. Minimum Default = 0, Maximum Default = 48.



C39MIN.
Minimum Message Length



C39MAX.
Maximum Message Length

Code 39 Append

This function allows the scanner to append the data from several Code 39 barcodes together before transmitting them to the host computer. When the scanner encounters a Code 39 barcode with the append trigger character(s), it buffers Code 39 barcodes until it reads a Code 39 barcode that does not have the append trigger. The data is then transmitted in the order in which the barcodes were read (FIFO). *Default = Off.*



Code 32 Pharmaceutical (PARAF)

Code 32 Pharmaceutical is a form of the Code 39 symbology used by Italian pharmacies. This symbology is also known as PARAF.



Full ASCII

If Full ASCII Code 39 decoding is enabled, certain character pairs within the barcode symbol will be interpreted as a single character. For example: \$V will be decoded as the ASCII character SYN, and /C will be decoded as the ASCII character #. *Default = Off.*

NUL %U	DLE \$P	SP SPACE	0 0	@ %V	P P	' %W	p +P
SOH \$A	DC1 \$Q	! /A	1 1	A A	Q Q	a +A	q +Q
STX \$B	DC2 \$R	" /B	2 2	B B	R R	b +B	r +R
ETX \$C	DC3 \$S	# /C	3 3	C C	S S	c +C	s +S
EOT \$D	DC4 \$T	\$ /D	4 4	D D	T T	d +D	t +T
ENQ \$E	NAK \$U	% /E	5 5	E E	U U	e +E	u +U
ACK \$F	SYN \$V	& /F	6 6	F F	V V	f +F	v +V
BEL \$G	ETB \$W	' /G	7 7	G G	W W	g +G	w +W
BS \$H	CAN \$X	(/H	8 8	H H	X X	h +H	x +X
HT \$I	EM \$Y) /I	9 9	I I	Y Y	i +I	y +Y
LF \$J	SUB \$Z	* /J	: /Z	J J	Z Z	j +J	z +Z
VT \$K	ESC %A	+ /K	; %F	K K	[%K	k +K	{ %P
FF \$L	FS %B	, /L	< %G	L L	\ %L	l +L	%Q
CR \$M	GS %C	- -	= %H	M M] %M	m +M	} %R
SO \$N	RS %D	. .	> %I	N N	^ %N	n +N	~ %S
SI \$O	US %E	/ /O	? %J	O O	_ %O	o +O	DEL %T

Character pairs /M and /N decode as a minus sign and period respectively. Character pairs /P through /Y decode as 0 through 9.



C39ASC1.
Full ASCII On



C39ASC0.
* Full ASCII Off

Code 39 Code Page

Code pages define the mapping of character codes to characters. If the data received does not display with the proper characters, it may be because the barcode being scanned was created using a code page that is different from the one the host program is expecting. If this is the case, scan the barcode below, select the

code page with which the barcodes were created (see [ISO 2022/ISO 646 Character Replacements](#) on page 220), and scan the value and the Save barcode from the [Programming Chart](#). The data characters should then appear properly.



C39DCP.

Code 39 Code Page

Interleaved 2 of 5

< Default All Interleaved 2 of 5 Settings >



I25DFT.

Interleaved 2 of 5 On/Off



I25ENA1.

* On



I25ENA0.

Off

Check Digit

No Check Digit indicates that the scanner reads and transmits barcode data with or without a check digit.

When Check Digit is set to **Validate, but Don't Transmit**, the unit only reads Interleaved 2 of 5 barcodes printed with a check digit, but will not transmit the check digit with the scanned data.

When Check Digit is set to **Validate and Transmit**, the scanner only reads Interleaved 2 of 5 barcodes printed with a check digit, and will transmit this digit at the end of the scanned data. *Default = No Check Digit.*



I25CK20.

* No Check Digit



I25CK21.

Validate, but Don't Transmit



I25CK22.

Validate and Transmit

Interleaved 2 of 5 Message Length

Scan the barcodes below to change the message length. Refer to [Message Length Description](#) (page 114) for additional information. Minimum and Maximum lengths = 2-80. Minimum Default = 4, Maximum Default = 80.



I25MIN.

Minimum Message Length



I25MAX.

Maximum Message Length

NEC 2 of 5

< Default All NEC 2 of 5 Settings >



N25DFT.

NEC 2 of 5 On/Off



N25ENA1.

* On



N25ENA0.

Off

Check Digit

No Check Digit indicates that the scanner reads and transmits barcode data with or without a check digit.

When Check Digit is set to **Validate, but Don't Transmit**, the unit only reads NEC 2 of 5 barcodes printed with a check digit, but will not transmit the check digit with the scanned data.

When Check Digit is set to **Validate and Transmit**, the scanner only reads NEC 2 of 5 barcodes printed with a check digit, and will transmit this digit at the end of the scanned data. *Default = No Check Digit.*



N25CK20.

* No Check Digit



N25CK21.

Validate, but Don't Transmit



N25CK22.

Validate and Transmit

NEC 2 of 5 Message Length

Scan the barcodes below to change the message length. Refer to [Message Length Description](#) (page 114) for additional information. Minimum and Maximum lengths = 2-80. Minimum Default = 4, Maximum Default = 80.



N25MIN.

Minimum Message Length



N25MAX.

Maximum Message Length

Code 93

< Default All Code 93 Settings >



Code 93 On/Off



Code 93 Message Length

Scan the barcodes below to change the message length. Refer to [Message Length Description](#) (page 114) for additional information. Minimum and Maximum lengths = 0-80. Minimum Default = 0, Maximum Default = 80.



Code 93 Append

This function allows the scanner to append the data from several Code 93 barcodes together before transmitting them to the host computer. When this function is enabled, the scanner stores those Code 93 barcodes that start with a space (excluding the start and stop symbols), and does not immediately transmit the data. The scanner stores the data in the order in which the barcodes are read,

deleting the first space from each. The scanner transmits the appended data when it reads a Code 93 barcode that starts with a character other than a space. *Default = Off.*



Code 93 Code Page

Code pages define the mapping of character codes to characters. If the data received does not display with the proper characters, it may be because the barcode being scanned was created using a code page that is different from the one the host program is expecting. If this is the case, scan the barcode below, select the code page with which the barcodes were created (see [ISO 2022/ISO 646 Character Replacements](#) on page 220), and scan the value and the **Save** barcode from the [Programming Chart](#). The data characters should then appear properly.



Straight 2 of 5 Industrial (three-bar start/stop)

<Default All Straight 2 of 5 Industrial Settings>



Straight 2 of 5 Industrial On/Off



Straight 2 of 5 Industrial Message Length

Scan the barcodes below to change the message length. Refer to [Message Length Description](#) (page 114) for additional information. Minimum and Maximum lengths = 1-48. Minimum Default = 4, Maximum Default = 48.



R25MIN.

Minimum Message Length



R25MAX.

Maximum Message Length

Straight 2 of 5 IATA (two-bar start/stop)

<Default All Straight 2 of 5 IATA Settings>



A25DFT.

Straight 2 of 5 IATA On/Off



A25ENA1.

On



A25ENA0.

*** Off**

Straight 2 of 5 IATA Message Length

Scan the barcodes below to change the message length. Refer to [Message Length Description](#) (page 114) for additional information. Minimum and Maximum lengths = 1-48. Minimum Default = 4, Maximum Default = 48.



A25MIN.

Minimum Message Length



A25MAX.

Maximum Message Length

Matrix 2 of 5

<Default All Matrix 2 of 5 Settings>



X25DFT.

Matrix 2 of 5 On/Off



X25ENA1.

On



X25ENA0.

* Off

Matrix 2 of 5 Message Length

Scan the barcodes below to change the message length. Refer to [Message Length Description](#) (page 114) for additional information. Minimum and Maximum lengths = 1-80. Minimum Default = 4, Maximum Default = 80.



X25MIN.

Minimum Message Length



X25MAX.

Maximum Message Length

Code 11

<Default All Code 11 Settings>



Code 11 On/Off



Check Digits Required

This option sets whether 1 or 2 check digits are required with Code 11 barcodes.
Default = Two Check Digits.



Code 11 Message Length

Scan the barcodes below to change the message length. Refer to [Message Length Description](#) (page 114) for additional information. Minimum and Maximum lengths = 1-80. Minimum Default = 4, Maximum Default = 80.



Code 128

<Default All Code 128 Settings>



Code 128 On/Off



ISBT 128 Concatenation

In 1994 the International Society of Blood Transfusion (ISBT) ratified a standard for communicating critical blood information in a uniform manner. The use of ISBT formats requires a paid license. The ISBT 128 Application Specification describes 1) the critical data elements for labeling blood products, 2) the current recommendation to use Code 128 due to its high degree of security and its space-efficient design, 3) a variation of Code 128 that supports concatenation of neighboring symbols, and 4) the standard layout for barcodes on a blood product label. Use the barcodes below to turn concatenation on or off. *Default =Off.*



Code 128 Message Length

Scan the barcodes below to change the message length. Refer to [Message Length Description](#) (page 114) for additional information. Minimum and Maximum lengths = 0-80. Minimum Default = 0, Maximum Default = 80.



Code 128 Append

This function allows the scanner to append the data from several Code 128 barcodes together before transmitting them to the host computer. When the scanner encounters a Code 128 barcode with the append trigger character(s), it buffers Code 128 barcodes until it reads a Code 128 barcode that does not have the append trigger. The data is then transmitted in the order in which the barcodes were read (FIFO). *Default = On.*



Code 128 Code Page

Code pages define the mapping of character codes to characters. If the data received does not display with the proper characters, it may be because the barcode being scanned was created using a code page that is different from the one the host program is expecting. If this is the case, scan the barcode below, select the code page with which the barcodes were created (see [ISO 2022/ISO 646 Character Replacements](#) on page 220), and scan the value and the Save barcode from the [Programming Chart](#). The data characters should then appear properly.



GS1-128

<Default All GS1-128 Settings>



GS1-128 On/Off



GS1-128 Message Length

Scan the barcodes below to change the message length. Refer to [Message Length Description](#) (page 114) for additional information. Minimum and Maximum lengths = 1-80. Minimum Default = 1, Maximum Default = 80.



Minimum Message Length



Maximum Message Length

UPC-A

<Default All UPC-A Settings>



UPC-A On/Off

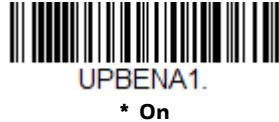

Note: To convert UPC-A barcodes to EAN-13, see [Convert UPC-A to EAN-13](#) on page 138.

UPC-A Check Digit

This selection allows you to specify whether the check digit should be transmitted at the end of the scanned data or not. *Default = On.*



UPC-A Number System

The numeric system digit of a U.P.C. symbol is normally transmitted at the beginning of the scanned data, but the unit can be programmed so it will not transmit it. *Default = On.*





UPC-A Addenda

This selection adds 2 or 5 digits to the end of all scanned UPC-A data.
Default = Off for both 2 Digit and 5 Digit Addenda.



UPC-A Addenda Required

When **Required** is scanned, the scanner will only read UPC-A barcodes that have addenda. You must then turn on a 2 or 5 digit addenda listed on [page 133](#). *Default = Not Required.*



UPC-A Addenda Separator

When this feature is on, there is a space between the data from the barcode and the data from the addenda. When turned off, there is no space. *Default = On.*



UPAADS1.

* On



UPAADS0.

Off

UPC-A/EAN-13 with Extended Coupon Code

Use the following codes to enable or disable UPC-A and EAN-13 with Extended Coupon Code. When left on the default setting (**Off**), the scanner treats Coupon Codes and Extended Coupon Codes as single barcodes.

If you scan the **Allow Concatenation** code, when the scanner sees the coupon code and the extended coupon code in a single scan, it transmits both as one symbology. Otherwise, it transmits the first coupon code it reads.

If you scan the **Require Concatenation** code, the scanner must see and read the coupon code and extended coupon code in a single read to transmit the data. No data is output unless both codes are read. *Default = Off.*



CPNENA0.

* Off



CPNENA1.

Allow Concatenation



CPNENA2.

Require Concatenation

Coupon GS1 DataBar Output

If you scan coupons that have both UPC and GS1 DataBar codes, you may wish to scan and output only the data from the GS1 DataBar code. Scan the **GS1 Output On** code below to scan and output only the GS1 DataBar code data. *Default = GS1 Output Off.*



UPC-E0

<Default All UPC-E Settings>



UPC-E0 On/Off

Most U.P.C. barcodes lead with the 0 number system. To read these codes, use the **UPC-E0 On** selection. If you need to read codes that lead with the 1 number system, use [UPC-E1](#) (page 137). *Default = On.*



UPC-E0 Expand

UPC-E Expand expands the UPC-E code to the 12 digit, UPC-A format. *Default = Off.*





UPC-E0 Addenda Required

When **Required** is scanned, the scanner will only read UPC-E barcodes that have addenda. *Default = Not Required.*



UPC-E0 Addenda Separator

When this feature is **On**, there is a space between the data from the barcode and the data from the addenda. When turned **Off**, there is no space. *Default = On.*



UPC-E0 Check Digit

Check Digit specifies whether the check digit should be transmitted at the end of the scanned data or not. *Default = On.*



UPC-E0 Leading Zero

This feature allows the transmission of a leading zero (0) at the beginning of scanned data. To prevent transmission, scan **Off**. *Default = On.*



UPENSX1.

* On



UPENSX0.

Off

UPC-E0 Addenda

This selection adds 2 or 5 digits to the end of all scanned UPC-E data. *Default = Off for both 2 Digit and 5 Digit Addenda.*



UPEAD21.

2 Digit Addenda On



UPEAD20.

* 2 Digit Addenda Off



UPEAD51.

5 Digit Addenda On



UPEAD50.

* 5 Digit Addenda Off

UPC-E1

Most U.P.C. barcodes lead with the 0 number system. For these codes, use [UPC-E0](#) (page 135). If you need to read codes that lead with the 1 number system, use the **UPC-E1 On** selection. *Default = Off.*



UPEEN11.

UPC-E1 On



EAN/JAN-13

<Default All EAN/JAN Settings>



EAN/JAN-13 On/Off



Convert UPC-A to EAN-13

When **UPC-A Converted to EAN-13** is selected, UPC-A barcodes are converted to 13 digit EAN-13 codes by adding a zero to the front. When **Do not Convert UPC-A** is selected, UPC-A codes are read as UPC-A.



EAN/JAN-13 Check Digit

This selection allows you to specify whether the check digit should be transmitted at the end of the scanned data or not. *Default = On.*



E13CKX1.

* On



E13CKX0.

Off

EAN/JAN-13 Addenda

This selection adds 2 or 5 digits to the end of all scanned EAN/JAN-13 data. *Default = Off for both 2 Digit and 5 Digit Addenda.*



E13AD21.

2 Digit Addenda On



E13AD20.

* 2 Digit Addenda Off



E13AD51.

5 Digit Addenda On



E13AD50.

* 5 Digit Addenda Off

EAN/JAN-13 Addenda Required

When **Required** is scanned, the scanner will only read EAN/JAN-13 barcodes that have addenda. *Default = Not Required.*



E13ARQ1.

Required



EAN/JAN-13 Addenda Separator

When this feature is **On**, there is a space between the data from the barcode and the data from the addenda. When turned **Off**, there is no space. *Default = On.*



Note: If you want to enable or disable EAN13 with Extended Coupon Code, refer to [UPC-A/ EAN-13 with Extended Coupon Code](#) (page 134).

ISBN Translate

When **On** is scanned, EAN-13 Bookland symbols are translated into their equivalent ISBN number format. *Default = Off.*



EAN/JAN-8

<Default All EAN/JAN-8 Settings>



EAN/JAN-8 On/Off



EAN/JAN-8 Check Digit

This selection allows you to specify whether the check digit should be transmitted at the end of the scanned data or not. *Default = On.*



EAN/JAN-8 Addenda

This selection adds 2 or 5 digits to the end of all scanned EAN/JAN-8 data. *Default = Off for both 2 Digit Addenda and 5 Digit Addenda.*





EA8AD51.

5 Digit Addenda On



EA8AD50.

* 5 Digit Addenda Off

EAN/JAN-8 Addenda Required

When **Required** is scanned, the scanner will only read EAN/JAN-8 barcodes that have addenda. *Default = Not Required.*



EA8ARQ1.

Required



EA8ARQ0.

* Not Required

EAN/JAN-8 Addenda Separator

When this feature is **On**, there is a space between the data from the barcode and the data from the addenda. When turned **Off**, there is no space. *Default = On.*



EA8ADS1.

* On



EA8ADS0.

Off

MSI

<Default All MSI Settings>



MSI On/Off



MSI Check Character

Different types of check characters are used with MSI barcodes. You can program the scanner to read MSI barcodes with Type 10 check characters. *Default = Validate Type 10, but Don't Transmit.*

When Check Character is set to **Validate Type 10/11 and Transmit**, the scanner will only read MSI barcodes printed with the specified type check character(s), and will transmit the character(s) at the end of the scanned data.

When Check Character is set to **Validate Type 10/11, but Don't Transmit**, the unit will only read MSI barcodes printed with the specified type check character(s), but will not transmit the check character(s) with the scanned data.





MSCHK3.

Validate 2 Type 10 Characters and Transmit



MSCHK4.

Validate Type 11 then Type 10 Character, but Don't Transmit



MSCHK5.

Validate Type 11 then Type 10 Character and Transmit



MSCHK6.

Disable MSI Check Characters

MSI Message Length

Scan the barcodes below to change the message length. Refer to [Message Length Description](#) (page 114) for additional information. Minimum and Maximum lengths = 4-48. Minimum Default = 4, Maximum Default = 48.



MSIMIN.

Minimum Message Length



MSIMAX.

Maximum Message Length

GS1 DataBar Omnidirectional

< Default All GS1 DataBar Omnidirectional Settings >



RSSDFT.

GS1 DataBar Omnidirectional On/Off



RSSENA1.

* On



GS1 DataBar Limited

< Default All GS1 DataBar Limited Settings >



GS1 DataBar Limited On/Off



GS1 DataBar Expanded

< Default All GS1 DataBar Expanded Settings >



GS1 DataBar Expanded On/Off



GS1 DataBar Expanded Message Length

Scan the barcodes below to change the message length. Refer to [Message Length Description](#) (page 114) for additional information. Minimum and Maximum lengths = 4-74. Minimum Default = 4, Maximum Default = 74.



RSEMIN.

Minimum Message Length



RSEMAX.

Maximum Message Length

Codablock A

<Default All Codablock A Settings>



CBADFT.

Codablock A On/Off



CBAENA1.

On



CBAENA0.

*** Off**

Codablock A Message Length

Scan the barcodes below to change the message length. Refer to [Message Length Description](#) (page 114) for additional information. Minimum and Maximum lengths = 1-600. Minimum Default = 1, Maximum Default = 600.



CBAMIN.

Minimum Message Length



CBAMAX.

Maximum Message Length

Codablock F

<Default All Codablock F Settings>



CBFDFD.

Codablock F On/Off



CBFENA1.

On



CBFENA0.

* Off

Codablock F Message Length

Scan the barcodes below to change the message length. Refer to [Message Length Description](#) (page 114) for additional information. Minimum and Maximum lengths = 1-2048. Minimum Default = 1, Maximum Default = 2048.



CBFMIN.

Minimum Message Length



CBFMAX.

Maximum Message Length

PDF417

< Default All PDF417 Settings >



PDF417 On/Off



PDF417 Message Length

Scan the barcodes below to change the message length. Refer to [Message Length Description](#) (page 114) for additional information. Minimum and Maximum lengths = 1-2750. Minimum Default = 1, Maximum Default = 2750.



MacroPDF417

MacroPDF417 is an implementation of PDF417 capable of encoding very large amounts of data into multiple PDF417 barcodes. When this selection is enabled, these multiple barcodes are assembled into a single data string. *Default = On.*





MicroPDF417

< Default All MicroPDF417 Settings >



MicroPDF417 On/Off



MicroPDF417 Message Length

Scan the barcodes below to change the message length. Refer to [Message Length Description](#) (page 114) for additional information. Minimum and Maximum lengths = 1-366. Minimum Default = 1, Maximum Default = 366.



GS1 Composite Codes

Linear codes are combined with a unique 2D composite component to form a new class called GS1 Composite symbology. GS1 Composite symbologies allow for the co-existence of symbologies already in use. *Default = Off.*



UPC/EAN Version

Scan the **UPC/EAN Version On** barcode to decode GS1 Composite symbols that have a U.P.C. or an EAN linear component. (This does not affect GS1 Composite symbols with a GS1-128 or GS1 linear component.) *Default = UPC/EAN Version Off.*



Note: *If you scan coupons that have both UPC and GS1 DataBar codes, you may wish to scan and output only the data from the GS1 DataBar code. See [Coupon GS1 DataBar Output](#) (page 135) for further information.*

GS1 Composite Code Message Length

Scan the barcodes below to change the message length. Refer to [Message Length Description](#) (page 114) for additional information. Minimum and Maximum lengths = 1-2435. Minimum Default = 1, Maximum Default = 2435.



GS1 Emulation

The scanner can automatically format the output from any GS1 data carrier to emulate what would be encoded in an equivalent GS1-128 or GS1 DataBar symbol. GS1 data carriers include UPC-A and UPC-E, EAN-13 and EAN-8, ITF-14, GS1-128, and GS1-128 DataBar and GS1 Composites. (Any application that accepts GS1 data can be simplified since it only needs to recognize one data carrier type.)

If **GS1-128 Emulation** is scanned, all retail codes (U.P.C., UPC-E, EAN8, EAN13) are expanded out to 16 digits. If the AIM ID is enabled, the value will be the GS1-128 AIM ID,]C1 (see [Symbology Charts](#) on page 213).

If **GS1 DataBar Emulation** is scanned, all retail codes (U.P.C., UPC-E, EAN8, EAN13) are expanded out to 16 digits. If the AIM ID is enabled, the value will be the GS1-DataBar AIM ID,]em (see [Symbology Charts](#) on page 213).

If **GS1 Code Expansion Off** is scanned, retail code expansion is disabled, and UPC-E expansion is controlled by the [UPC-E0 Expand](#) (page 135) setting. If the AIM ID is enabled, the value will be the GS1-128 AIM ID,]C1 (see [Symbology Charts](#) on page 213).

If **EAN8 to EAN13 Conversion** is scanned, all EAN8 barcodes are converted to EAN13 format.

Default = GS1 Emulation Off.

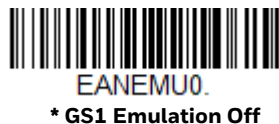
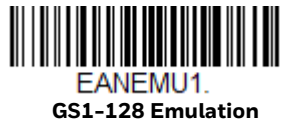

TCIF Linked Code 39 (TLC39)

This code is a composite code since it has a Code 39 linear component and a MicroPDF417 stacked code component. All barcode readers are capable of reading the Code 39 linear component. The MicroPDF417 component can only be decoded if TLC39 On is selected. The linear component may be decoded as Code 39 even if TLC39 is off. *Default = Off.*



QR Code

< Default All QR Code Settings >



QR Code On/Off

This selection applies to both QR Code and Micro QR Code.



QR Code Message Length

Scan the barcodes below to change the message length. Refer to [Message Length Description](#) (page 114) for additional information. Minimum and Maximum lengths = 1-7089. Minimum Default = 1, Maximum Default = 7089.



QRCMIN.

Minimum Message Length



QRCMAX.

Maximum Message Length

QR Code Append

This function allows the scanner to append the data from several QR Code barcodes together before transmitting them to the host computer. When the scanner encounters an QR Code barcode with the append trigger character(s), it buffers the number of QR Code barcodes determined by information encoded in those barcodes. Once the proper number of codes is reached, the data is output in the order specified in the barcodes. There are 3 ways to scan appended QR Code:

- **One scan**—Pull the trigger one time and all appended QR Codes in the same image are decoded
- **Swipe**—Pull and hold down the trigger and scan all appended QR Codes while keeping the trigger pressed. The scanner emits short beeps for each partial QR Code that is scanned and buffered. One long beep is emitted after the last QR Code is scanned and the data is complete. Not compatible with Presentation mode.
- **Point and shoot**—Pull the trigger one time for each image. The scanner emits a short beep for each partial QR Code that is scanned and buffered. One long beep is emitted after the last QR Code is scanned and the data is complete. Not compatible with Presentation mode.

Default = One Scan.



QRCAPP1.

* One Scan



QRCAPP2.

Swipe



QRCAPP3.

Point and Shoot



QR Code Page

QR Code pages define the mapping of character codes to characters. If the data received does not display with the proper characters, it may be because the barcode being scanned was created using a code page that is different from the one the host program is expecting. If this is the case, scan the barcode below, select the code page with which the barcodes were created (see [ISO 2022/ISO 646 Character Replacements](#) on page 220), and scan the value and the Save barcode from the [Programming Chart](#). The data characters should then appear properly.



Data Matrix

< Default All Data Matrix Settings >



Data Matrix On/Off



Data Matrix Message Length

Scan the barcodes below to change the message length. Refer to [Message Length Description](#) (page 114) for additional information. Minimum and Maximum lengths = 1-3116. Minimum Default = 1, Maximum Default = 3116.



IDMMIN.

Minimum Message Length



IDMMAX.

Maximum Message Length

Data Matrix Code Page

Data Matrix Code pages define the mapping of character codes to characters. If the data received does not display with the proper characters, it may be because the barcode being scanned was created using a code page that is different from the one the host program is expecting. If this is the case, scan the barcode below, select the code page with which the barcodes were created (see [ISO 2022/ISO 646 Character Replacements](#) on page 220), and scan the value and the Save barcode from the [Programming Chart](#). The data characters should then appear properly.



IDMDCP.

Data Matrix Code Page

MaxiCode

< Default All MaxiCode Settings >



MAXDFT.

MaxiCode On/Off



MAXENA0.

On



MAXENA0.

* Off

MaxiCode Message Length

Scan the barcodes below to change the message length. Refer to [Message Length Description](#) (page 114) for additional information. Minimum and Maximum lengths = 1-150. Minimum Default = 1, Maximum Default = 150.



MAXMIN.

Minimum Message Length



MAXMAX.

Maximum Message Length

Aztec Code

< Default All Aztec Code Settings >



AZTDFT.

Aztec Code On/Off



AZTENA1.

* On



AZTENA0.

Off

Aztec Code Message Length

Scan the barcodes below to change the message length. Refer to [Message Length Description](#) (page 114) for additional information. Minimum and Maximum lengths = 1-3832. Minimum Default = 1, Maximum Default = 3832.



AZTMIN.

Minimum Message Length



Aztec Append

This function allows the scanner to append the data from several Aztec barcodes together before transmitting them to the host computer. When the scanner encounters an Aztec barcode with the append trigger character(s), it buffers the number of Aztec barcodes determined by information encoded in those barcodes. Once the proper number of codes is reached, the data is output in the order specified in the barcodes. There are 3 ways to scan appended Aztec Code:

- **One scan**—Pull the trigger one time and all appended Aztec Codes in the same image are decoded
- **Swipe**—Pull and hold down the trigger and scan all appended Aztec Codes while keeping the trigger pressed. The scanner emits short beeps for each partial Aztec Code that is scanned and buffered. One long beep is emitted after the last Aztec Code is scanned and the data is complete. Not compatible with Presentation mode.
- **Point and shoot**—Pull the trigger one time for each image. The scanner emits a short beep for each partial Aztec Code that is scanned and buffered. One long beep is emitted after the last Aztec Code is scanned and the data is complete. Not compatible with Presentation mode.

Default = One Scan.



AZTAPP1.
* One Scan



AZTAPP2.
Swipe



AZTAPP3.
Point and Shoot



AZTAPP0.
Off

Aztec Code Page

Aztec Code pages define the mapping of character codes to characters. If the data received does not display with the proper characters, it may be because the barcode being scanned was created using a code page that is different from the one the host program is expecting. If this is the case, scan the barcode below, select the code page with which the barcodes were created (see [ISO 2022/ISO 646 Character Replacements](#) on page 220), and scan the value and the Save barcode from the [Programming Chart](#). The data characters should then appear properly.



Aztec Code Page

Chinese Sensible (Han Xin) Code

< Default All Han Xin Settings >



Han Xin Code On/Off

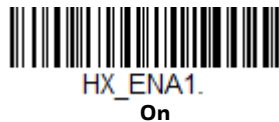

Han Xin Code Message Length

Scan the barcodes below to change the message length. Refer to [Message Length Description](#) (page 114) for additional information. Minimum and Maximum lengths = 1-7833. Minimum Default = 1, Maximum Default = 7833.



Postal Codes - 2D

The following lists the possible 2D postal codes, and 2D postal code combinations that are allowed. Only one 2D postal code selection can be active at a time. If you scan a second 2D postal code selection, the first selection is overwritten. *Default = 2D Postal Codes Off.*



POSTAL0.

* 2D Postal Codes Off

Single 2D Postal Codes:



POSTAL1.

Australian Post On



POSTAL7.

British Post On



POSTAL30.

Canadian Post On



POSTAL10.

Intelligent Mail Barcode On



POSTAL3.

Japanese Post On



POSTAL4.

KIX Post On



POSTAL5.

Planet Code On

Also see [Planet Code Check Digit](#), page 162.



POSTAL9.

Postal-4i On



POSTAL6.
Postnet On

Also see [Postnet Check Digit](#) on page 162.



POSTAL11.
Postnet with B and B' Fields On



POSTAL2.
InfoMail On

Combination 2D Postal Codes:



POSTAL8.
InfoMail and British
Post On



POSTAL20.
Intelligent Mail Barcode and
Postnet with B and B' Fields On



POSTAL14.
Postnet and
Postal-4i On



POSTAL16.
Postnet and
Intelligent Mail Barcode On



POSTAL17.
Postal-4i and
Intelligent Mail Barcode On



POSTAL19.
Postal-4i and
Postnet with B and B' Fields On



POSTAL12.
Planet Code and
Postnet On



POSTAL13.
Planet Code and
Postal-4i On



POSTAL21.
Planet Code,
Postnet, and
Postal-4i On



POSTAL23.
Planet Code,
Postal-4i, and
Intelligent Mail Barcode On



POSTAL25.
Planet Code,
Postal-4i, and
Postnet with B and B' Fields On



POSTAL18.
Planet Code and
Postnet with B and B' Fields On



POSTAL15.
Planet Code and
Intelligent Mail Barcode



POSTAL22.
Planet Code,
Postnet, and
Intelligent Mail Barcode On



POSTAL24.
Postnet,
Postal-4i, and
Intelligent Mail Barcode On



POSTAL26.
Planet Code,
Intelligent Mail Barcode, and
Postnet with B and B' Fields On



POSTAL27.
Postal-4i,
Intelligent Mail Barcode, and
Postnet with B and B' Fields On



POSTAL28.
Planet Code,
Postal-4i,
Intelligent Mail Barcode, and
Postnet On



POSTAL29.
Planet Code,
Postal-4i,
Intelligent Mail Barcode, and
Postnet with B and B' Fields On

Planet Code Check Digit

This selection allows you to specify whether the check digit should be transmitted at the end of Planet Code data. *Default = Don't Transmit.*



PLNCKX1.
Transmit Check Digit



PLNCKX0.
*** Don't Transmit Check Digit**

Postnet Check Digit

This selection allows you to specify whether the check digit should be transmitted at the end of Postnet data. *Default = Don't Transmit.*



NETCKX1.
Transmit Check Digit



NETCKX0.
*** Don't Transmit Check Digit**

Australian Post Interpretation

This option controls what interpretation is applied to customer fields in Australian 4-State symbols.

Bar Output lists the bar patterns in “0123” format.

Numeric N Table causes that field to be interpreted as numeric data using the N Table.

Alphanumeric C Table causes the field to be interpreted as alphanumeric data using the C Table. Refer to the Australian Post Specification Tables.

Combination C and N Tables causes the field to be interpreted using either the C or N Tables.



AUSINT0.

* Bar Output



AUSINT1.

Numeric N Table



AUSINT2.

Alphanumeric C Table



AUSINT3.

Combination C and N Tables

Postal Codes - Linear

The following lists linear postal codes. Any combination of linear postal code selections can be active at a time.

China Post (Hong Kong 2 of 5)

<Default All China Post (Hong Kong 2 of 5) Settings>



CPCDFT.

China Post (Hong Kong 2 of 5) On/Off



China Post (Hong Kong 2 of 5) Message Length

Scan the barcodes below to change the message length. Refer to [Message Length Description](#) (page 114) for additional information. Minimum and Maximum lengths = 2-80. Minimum Default = 4, Maximum Default = 80.



Korea Post

<Default All Korea Post Settings>



Korea Post On/Off



Korea Post Message Length

Scan the barcodes below to change the message length. Refer to [Message Length Description](#) (page 114) for additional information. Minimum and Maximum lengths = 2-80. Minimum Default = 4, Maximum Default = 48.



KPCMIN.

Minimum Message Length



KPCMAX.

Maximum Message Length

Korea Post Check Digit

This selection allows you to specify whether the check digit should be transmitted.
Default = Don't Transmit.



KPCCHK1.

Transmit Check Digit



KPCCHK0.

*** Don't Transmit Check Digit**

Add a Test Code I.D. Prefix to All Symbologies

This selection allows you to turn on transmission of a Code I.D. before the decoded symbology. (See the [Symbology Charts](#), beginning on page 213) for the single character code that identifies each symbology.) This action first clears all current prefixes, then programs a Code I.D. prefix for all symbologies. This is a temporary setting that will be removed when the unit is power cycled.



PRECA2,BK2995C80!

**Add Code I.D. Prefix to
All Symbologies (Temporary)**

Show Decoder Library Version

Scan the barcode below to output the decoder library version.



REV_AD.

**Show Decoder Library
Version**

Show Software Revision

Scan the barcode below to output the current software revision, unit serial number, and other product information for both the scanner and the base.



REVINF.

Show Revision

Show Data Format

See "Show Data Format" on page 100.

Test Menu

When you scan the **Test Menu On** code, then scan a programming code in this manual, the scanner displays the content of a programming code. The programming function will still occur, but in addition, the content of that programming code is output to the terminal.

Note: *This feature should not be used during normal scanner operation.*



EZConfig for Scanning Introduction

EZConfig for Scanning provides a wide range of PC-based programming functions that can be performed on a scanner connected to your PC. EZConfig for Scanning allows you to download upgrades to the scanner's firmware, change programmed parameters, and create and print programming barcodes. Using EZConfig for Scanning, you can even save/open the programming parameters for a scanner. This saved file can be e-mailed or, if required, you can create a single barcode that contains all the customized programming parameters and mail or fax that barcode to any location. Users in other locations can scan the barcode to load in the customized programming.

EZConfig for Scanning Operations

The EZConfig for Scanning software performs the following operations:

Scan Data

Scan Data allows you to scan barcodes and display the barcode data in a window. Scan Data lets you send serial commands to the scanner and receive scanner response that can be seen in the Scan Data window. The data displayed in the Scan Data window can either be saved in a file or printed.

Configure

Configure displays the programming and configuration data of the scanner. The scanner's programming and configuration data is grouped into different categories. Each category is displayed as a tree item under the "Configure" tree node in the application explorer. When one of these tree nodes is clicked, the right-hand side is loaded with the parameters' form belonging to that particular category. The "Configure" tree option has all the programming and configuration parameters specified for a scanner. You can set or modify these parameters as required. You can later write the modified settings to the scanner, or save them to a dcf file.

Install EZConfig Cloud for Scanning

Use the EZConfig Cloud for Scanning tool to configure your scanner online:

1. Access the Honeywell web site at honeywell.com/PSSsoftware-downloads.
2. Click on the **Browse Products** tab. Under **Software**, select **Device Management**.
3. Click on **EZConfig Cloud for Scanning**.
4. Scroll to the bottom of the page and click on **Register for free access now** to sign up.

Reset the Factory Defaults



Caution: *This selection erases all your settings and resets the scanner to the original factory defaults. It also disables all plugins.*

If you aren't sure what programming options are in your scanner, or you've changed some options and want to restore the scanner to factory default settings, first scan the **Remove Custom Defaults** barcode, then scan **Activate Defaults**. This resets the scanner to the factory default settings.



DEFOVR.

Remove Custom Defaults



DEFAULT.

Activate Defaults

Note: *If using a cordless system, scanning the **Activate Defaults** barcode also causes both the scanner and the base or Access Point to perform a reset and become unlinked. The scanner must be placed in its base to re-establish the link before any setup codes are entered. If using an Access Point, the linking barcode must be scanned. See [Cordless System Operation](#) beginning on page 37 for additional information.*

The [Menu Commands](#), beginning on page 175 list the factory default settings for each of the commands (indicated by an asterisk (*) on the programming pages).

SERIAL PROGRAMMING COMMANDS

The serial programming commands can be used in place of the programming barcodes. Both the serial commands and the programming barcodes will program the scanner. For complete descriptions and examples of each serial programming command, refer to the corresponding programming barcode in this manual.

The device must be set to an RS232 interface (see [page 12](#)). The following commands can be sent via a PC COM port using terminal emulation software.

Conventions

The following conventions are used for menu and query command descriptions:

<i>parameter</i>	A label representing the actual value you should send as part of a command.
[<i>option</i>]	An optional part of a command.
{Data}	Alternatives in a command.
bold	Names of menus, menu commands, buttons, dialog boxes, and windows that appear on the screen.

Menu Command Syntax

Menu commands have the following syntax (spaces have been used for clarity only):

Prefix [*:Name:*] *Tag SubTag {Data}* [, *SubTag {Data}*] [*; Tag SubTag {Data}*] [...] *Storage*

Prefix Three ASCII characters: SYN M CR (ASCII 22,77,13).

:Name: This command is only used with cordless devices. It is used to specify whether you're communicating with the base or the scanner. To send information to the scanner (with the base connected to host), use **:Voyager_1472g**: The default factory setting for a Voyager 1472g

scanner is Voyager_1472 scanner. This setting is changed by using the BT_NAM command, which accepts alphanumeric values. If the name is not known, a wildcard (*) can be used :*:

Note: *Since the base stores all work group settings and transfers to them to scanner once they are linked, changes are typically done to the base and not to the scanner.*

Tag	A 3 character case-insensitive field that identifies the desired menu command group. For example, all RS232 configuration settings are identified with a Tag of 232 .
SubTag	A 3 character case-insensitive field that identifies the desired menu command within the tag group. For example, the SubTag for the RS232 baud rate is BAD .
Data	The new value for a menu setting, identified by the Tag and SubTag.
Storage	A single character that specifies the storage table to which the command is applied. An exclamation point (!) performs the command's operation on the device's volatile menu configuration table. A period (.) performs the command's operation on the device's non-volatile menu configuration table. Use the non-volatile table only for semi-permanent changes you want saved through a power cycle.

Query Commands

Several special characters can be used to query the device about its settings.

^	What is the default value for the setting(s).
?	What is the device's current value for the setting(s).
*	What is the range of possible values for the setting(s). (The device's response uses a dash (-) to indicate a continuous range of values. A pipe () separates items in a list of non-continuous values.)

:Name: Field Usage (Optional)

This command returns the query information from the scanner.

Tag Field Usage

When a query is used in place of a Tag field, the query applies to the *entire* set of commands available for the particular storage table indicated by the Storage field of the command. In this case, the SubTag and Data fields should not be used because they are ignored by the device.

SubTag Field Usage

When a query is used in place of a SubTag field, the query applies only to the subset of commands available that match the Tag field. In this case, the Data field should not be used because it is ignored by the device.

Data Field Usage

When a query is used in place of the Data field, the query applies only to the specific command identified by the Tag and SubTag fields.

Concatenation of Multiple Commands

Multiple commands can be issued within one Prefix/Storage sequence. Only the Tag, SubTag, and Data fields must be repeated for each command in the sequence. If additional commands are to be applied to the same Tag, then the new command sequence is separated with a comma (,) and only the SubTag and Data fields of the additional command are issued. If the additional command requires a different Tag field, the command is separated from previous commands by a semicolon (;).

Responses

The device responds to serial commands with one of three responses:

- | | |
|------------|---|
| ACK | Indicates a good command which has been processed. |
| ENQ | Indicates an invalid Tag or SubTag command. |
| NAK | Indicates the command was good, but the Data field entry was out of the allowable range for this Tag and SubTag combination, e.g., an entry for a minimum message length of 100 when the field will only accept 2 characters. |

When responding, the device echoes back the command sequence with the status character inserted directly before each of the punctuation marks (the period, exclamation point, comma, or semicolon) in the command.

Examples of Query Commands

In the following examples, a bracketed notation [] depicts a non-displayable response.

Example: What is the range of possible values for Codabar Coding Enable?

Enter: **cbrena*.**

Response: **CBRENA0-1[ACK]**

This response indicates that Codabar Coding Enable (CBRENA) has a range of values from 0 to 1 (off and on).

Example: What is the default value for Codabar Coding Enable?

Enter: **cbrena^.**

Response: **CBRENA1[ACK]**

This response indicates that the default setting for Codabar Coding Enable (CBRENA) is 1, or on.

Example: What is the device's current setting for Codabar Coding Enable?

Enter: **cbrena?.**

Response: **CBRENA1[ACK]**

This response indicates that the device's Codabar Coding Enable (CBRENA) is set to 1, or on.

Example: What are the device's settings for all Codabar selections?

Enter: **cbr?.**

Response: **CBRENA1[ACK],**
 SSX0[ACK],
 CK20[ACK],
 CCT1[ACK],
 MIN2[ACK],
 MAX60[ACK],
 DFT[ACK].

This response indicates that the device's Codabar Coding Enable (CBRENA) is set to 1, or on;
the Start/Stop Character (SSX) is set to 0, or Don't Transmit;
the Check Character (CK2) is set to 0, or Not Required;
concatenation (CCT) is set to 1, or Enabled;
the Minimum Message Length (MIN) is set to 2 characters;
the Maximum Message Length (MAX) is set to 60 characters;
and the Default setting (DFT) has no value.

Trigger Commands

You can activate and deactivate the scanner with serial trigger commands. First, the scanner must be put in Manual Trigger Mode by scanning a Manual Trigger Mode barcode ([page 78](#)), or by sending a serial menu command for triggering ([page 79](#)). Once the scanner is in serial trigger mode, the trigger is activated and deactivated by sending the following commands:

Activate: **SYN T CR**

Deactivate: **SYN U CR**

The scanner scans until a barcode has been read, until the deactivate command is sent, or until the serial time-out has been reached (see "Read Time-Out" on page 4-79 for a description, and the serial command on [page 184](#)).

Reset the Custom Defaults

If you want the custom default settings restored to your scanner, scan the **Activate Custom Defaults** barcode below. This resets the scanner to the custom default settings. If there are no custom defaults, it will reset the scanner to the factory default settings. Any settings that have not been specified through the custom defaults will be defaulted to the factory default settings.



Activate Custom Defaults

Note: *If using a cordless system, scanning this barcode also causes both the scanner and the base or Access Point to perform a reset and become unlinked. The scanner must be placed in its base to re-establish the link. If using an Access Point, the linking barcode must be scanned. See [Cordless System Operation](#) beginning on page 37 for additional information.*

The charts on the following pages list the factory default settings for each of the commands (indicated by an asterisk (*) on the programming pages).

Menu Commands

Selection	Setting * Indicates default	Serial Command # Indicates a numeric entry	Page
Product Default Settings			
Set Custom Defaults	Set Custom Defaults	MNUCDP	8
	Save Custom Defaults	MNUCDS	8
Reset the Custom Defaults	Activate Custom Defaults	DEFAULT	9
Program the Interface			
Plug and Play Codes	Keyboard Wedge: IBM PC AT and Compatibles with CR suffix	PAP_AT	11
	Laptop Direct Connect with CR suffix	PAPLTD	12
	RS232 Serial Port	PAP232	12
Plug and Play Codes: RS485	IBM Port 5B Interface	PAPP5B	12
	IBM Port 9B HHBCR-1 Interface	PAP9B1	12
	IBM Port 17 Interface	PAPP17	13

Selection	Setting * Indicates default	Serial Command # Indicates a numeric entry	Page
	IBM Port 9B HHBCR-2 Interface	PAP9B2	13
	RS485 Packet Mode On	RTLPDF1	13
	*RS485 Packet Mode Off	RTLPDF0	13
	RS485 Packet Length (20-256) *40	RTLMPS	13
Plug and Play Codes: IBM SurePos	USB IBM SurePos Handheld	PAPSPH	14
	USB IBM SurePos Tabletop	PAPSPT	14
Plug and Play Codes: USB	USB Keyboard (PC)	PAP124	14
	USB Keyboard (Mac)	PAP125	14
	USB Japanese Keyboard (PC)	TRMUSB134	14
	USB HID	PAP131	15
	USB Serial	TRMUSB130	15
	CTS/RTS Emulation On	USBCTS1	15
	CTS/RTS Emulation Off*	USBCTS0	15
	ACK/NAK Mode On	USBACK1	15
	ACK/NAK Mode Off*	USBACK0	15
Remote MasterMind for USB	ReM Off	REMIFC0	16
	*ReM On	REMIFC1	16
Plug and Play Codes	Verifone Ruby Terminal	PAPRBY	16
	Gilbarco Terminal	PAPGLB	17
	Honeywell Bioptic Aux Port	PAPBIO	17
	Datalogic Magellan Bioptic Aux Port	PAPMAG	17
	NCR Bioptic Aux Port	PAPNCR	18
	Wincor Nixdorf Terminal	PAPWNX	18
	Wincor Nixdorf Beetle	PAPBTL	19
	Wincor Nixdorf RS232 Mode A	PAPWMA	19
Program Keyboard Country	*U.S.A.	KBDCTY0	20
	Albania	KBDCTY35	20
	Azeri (Cyrillic)	KBDCTY81	20
	Azeri (Latin)	KBDCTY80	20
	Belarus	KBDCTY82	20
	Belgium	KBDCTY1	20
	Bosnia	KBDCTY33	20
	Brazil	KBDCTY16	20
	Brazil (MS)	KBDCTY59	20
	Bulgaria (Cyrillic)	KBDCTY52	21
	Bulgaria (Latin)	KBDCTY53	21
	Canada (French legacy)	KBDCTY54	21

Selection	Setting * Indicates default	Serial Command # Indicates a numeric entry	Page
	Canada (French)	KBDCTY18	21
	Canada (Multilingual)	KBDCTY55	21
	Croatia	KBDCTY32	21
	Czech	KBDCTY15	21
	Czech (Programmers)	KBDCTY40	21
	Czech (QWERTY)	KBDCTY39	21
	Czech (QWERTZ)	KBDCTY38	21
	Denmark	KBDCTY8	21
	Dutch (Netherlands)	KBDCTY11	22
	Estonia	KBDCTY41	22
	Faroese	KBDCTY83	22
	Finland	KBDCTY2	22
	France	KBDCTY3	22
	Gaelic	KBDCTY84	22
	Germany	KBDCTY4	22
	Greek	KBDCTY17	22
	Greek (220 Latin)	KBDCTY64	22
	Greek (220)	KBDCTY61	22
	Greek (319 Latin)	KBDCTY65	22
	Greek (319)	KBDCTY62	22
	Greek (Latin)	KBDCTY63	23
	Greek (MS)	KBDCTY66	23
	Greek (Polytonic)	KBDCTY60	23
	Hebrew	KBDCTY12	23
	Hungarian (101 key)	KBDCTY50	23
	Hungary	KBDCTY19	23
	Iceland	KBDCTY75	23
	Irish	KBDCTY73	23
	Italian (142)	KBDCTY56	23
	Italy	KBDCTY5	23
	Japan ASCII	KBDCTY28	23
	Kazakh	KBDCTY78	24
	Kyrgyz (Cyrillic)	KBDCTY79	24
	Latin America	KBDCTY14	24
	Latvia	KBDCTY42	24
	Latvia (QWERTY)	KBDCTY43	24
	Lithuania	KBDCTY44	24

Selection	Setting * Indicates default	Serial Command # Indicates a numeric entry	Page
	Lithuania (IBM)	KBDCTY45	24
	Macedonia	KBDCTY34	24
	Malta	KBDCTY74	24
	Mongolian (Cyrillic)	KBDCTY86	24
	Norway	KBDCTY9	24
	Poland	KBDCTY20	24
	Polish (214)	KBDCTY57	25
	Polish (Programmers)	KBDCTY58	25
	Portugal	KBDCTY13	25
	Romania	KBDCTY25	25
	Russia	KBDCTY26	25
	Russian (MS)	KBDCTY67	25
	Russian (Typewriter)	KBDCTY68	25
	SCS	KBDCTY21	25
	Serbia (Cyrillic)	KBDCTY37	25
	Serbia (Latin)	KBDCTY36	25
	Slovakia	KBDCTY22	25
	Slovakia (QWERTY)	KBDCTY49	26
	Slovakia (QWERTZ)	KBDCTY48	26
	Slovenia	KBDCTY31	26
	Spain	KBDCTY10	26
	Spanish variation	KBDCTY51	26
	Sweden	KBDCTY23	26
	Switzerland (French)	KBDCTY29	26
	Switzerland (German)	KBDCTY6	26
	Tatar	KBDCTY85	26
	Turkey F	KBDCTY27	26
	Turkey Q	KBDCTY24	26
	Ukrainian	KBDCTY76	26
	United Kingdom	KBDCTY7	27
	United Stated (Dvorak right)	KBDCTY89	27
	United States (Dvorak left)	KBDCTY88	27
	United States (Dvorak)	KBDCTY87	27
	United States (International)	KBDCTY30	27
	Uzbek (Cyrillic)	KBDCTY77	27
Keyboard Style	*Regular	KBDSTY0	27
	Caps Lock	KBDSTY1	27

Selection	Setting * Indicates default	Serial Command # Indicates a numeric entry	Page
	Shift Lock	KBDSTY2	28
	Automatic Caps Lock	KBDSTY6	28
	Emulate External Keyboard	KBDSTY5	28
Keyboard Conversion	*Keyboard Conversion Off	KBDCNV0	29
	Convert all Characters to Upper Case	KBDCNV1	29
	Convert all Characters to Lower Case	KBDCNV1	29
Control Character Output	*Control Character Output Off	KBDNPE0	29
	*Control Character Output On	KBDNPE1	29
Keyboard Modifiers	*Control + ASCII Off	KBDCAS0	30
	DOS Mode Control + ASCII On	KBDCAS1	30
	Windows Mode Control + ASCII On	KBDCAS2	30
	Windows Mode Prefix/Suffix Off	KBDCAS3	30
	*Turbo Mode Off	KBDTMD0	30
	Turbo Mode On	KBDTMD1	30
	*Numeric Keypad Off	KBDNPS0	30
	Numeric Keypad On	KBDNPS1	30
	*Auto Direct Connect Off	KBDADC0	31
	Auto Direct Connect On	KBDADC1	31
Baud Rate	300 BPS	232BAD0	31
	600 BPS	232BAD1	31
	1200 BPS	232BAD2	31
	2400 BPS	232BAD3	31
	4800 BPS	232BAD4	31
	9600 BPS	232BAD5	32
	19200 BPS	232BAD6	32
	38400 BPS	232BAD7	32
	57600 BPS	232BAD8	32
	*115200 BPS	232BAD9	32
Word Length: Data Bits, Stop Bits, and Parity	7 Data, 1 Stop, Parity Even	232WRD3	32
	7 Data, 1 Stop, Parity None	232WRD0	32
	7 Data, 1 Stop, Parity Odd	232WRD6	32
	7 Data, 2 Stop, Parity Even	232WRD4	32
	7 Data, 2 Stop, Parity None	232WRD1	32
	7 Data, 2 Stop, Parity Odd	232WRD7	33
	8 Data, 1 Stop, Parity Even	232WRD5	33
	*8 Data, 1 Stop, Parity None	232WRD2	33
	8 Data, 1 Stop, Parity Odd	232WRD8	33

Selection	Setting * Indicates default	Serial Command # Indicates a numeric entry	Page
RS232 Receiver Time-out	Range 0 - 300 seconds (*0)	232LPT###	33
RS232 Handshaking	*RTS/CTS Off	232CTS0	34
	Flow Control, No Timeout	232CTS1	34
	Two-Direction Flow Control	232CTS2	34
	Flow Control with Timeout	232CTS3	34
	RS232 Timeout (Range 1-5100ms)	232DEL####	34
	*XON/XOFF Off	232XON0	35
	XON/XOFF On	232XON1	34
	*ACK/NAK Off	232ACK0	35
ACK/NAK On	232ACK1	35	
Scanner-Bioptic Packet Mode	*Packet Mode Off	232PKT0	35
	Packet Mode On	232PKT2	35
Scanner-Bioptic ACK/NAK Mode	*Bioptic ACK/NAK Off	232NAK0	36
	Bioptic ACK/NAK On	232NAK1	36
Scanner-Bioptic ACK/NAK Timeout	ACK/NAK Timeout (Range 1-5100ms) *5100	232DLK#####	36
Cordless System Operation			
<i>Note: This section applies only to cordless systems. It does not apply to corded scanners.</i>			
Replace a Linked Scanner	Override Locked Scanner (Single Scanner)	BT_RPL1	39
Base Power Communication Indicator	*On	*:BASRED1	44
	Off	*:BASREDO	44
Reset Scanner	Reset Scanner	RESET_	45
Scan While in Base Cradle	Scanning in Cradle Off	BT_SIC0	45
	*Scanning in Cradle On	BT_SIC1	45
	Shut Down Scanner In Cradle	BT_SIC2	45
Base Charge Modes	Base Charge Off	BASCHG0	46
	*External or Interface Cable Power	BASCHG1	46
	External Power Only	BASCHG2	46
Page Mode	*On	BEPPGE1	46
	Off	BEPPGE0	46
Page Pitch	Low (*1000 Hz)	BEPPFQ1000	47
	Medium (3250 Hz)	BEPPFQ3250	47
	High (4200)	BEPPFQ4200	47
Beeper Pitch - Base Error	*Razz (250) (min 200Hz)	BASFQ2250	47
	Medium (3250)	BASFQ23250	47
	High (4200) (max 9000Hz)	BASFQ24200	47

Selection	Setting * Indicates default	Serial Command # Indicates a numeric entry	Page
Number of Beeps - Base Error	Range 1 - 9 (*1)	BASERR#	48
Scanner Report	Scanner Report	RPTSCN	48
Scanner Address	Scanner Address	BT_LDA	48
Base Address	Base Address	BASLDA	48
Scanner Modes	Charge Only Mode	BASLNK0	49
	*Charge and Link Mode	BASLNK1	49
	Locked Link Mode	BASCON0,DNG1	49
	*Open Link Mode	BASCON1,DNG1	50
	Unlink Scanner	BT_RMV	49
	Override Locked Scanner	BT_RPL1	50
Out-of-Range Alarm	Base Alarm Duration (Range 1 - 3000 sec (*0))	BASORD	51
	Scanner Alarm Duration (Range 1 - 3000 sec (*0))	BT_ORD	51
Alarm Sound Type	Base Alarm Type (Range 0-7 (*0))	BASORW	51
	Scanner Alarm Type (Range 0-7 (*0))	BT_ORW	52
Scanner Power Time-Out Timer	Timer (0-7200 seconds)	BT_LPT0	52
	200 Seconds	BT_LPT200	52
	400 Seconds	BT_LPT400	52
	900 Seconds	BT_LPT900	52
	* 3600 Seconds	BT_LPT3600	52
	7200 Seconds	BT_LPT7200	52
Flexible Power Management	*Full Power	BT_TXP100	53
	Medium Power	BT_TXP35	53
	Medium Low Power	BT_TXP5	53
	Low Power	BT_TXP1	53
Batch Mode	Automatic Batch Mode	BATENA1	54
	*Batch Mode Off	BATENA0	54
	Inventory Batch Mode	BATENA2	54
	Persistent Batch Mode	BATENA3	54
Batch Mode Beep	Off	BATBEPO	55
	*On	BATBEP1	55
Batch Mode Storage	*Flash Storage	BATNVS1	55
	RAM Storage	BATNVS0	55
Batch Mode Quantity	*Off	BATQTY0	56
	On	BATQTY1	56

Selection	Setting * Indicates default	Serial Command # Indicates a numeric entry	Page
Quantity Codes	0	BATNUM0	56
	*1	BATNUM1	57
	2	BATNUM2	57
	3	BATNUM3	57
	4	BATNUM4	57
	5	BATNUM5	57
	6	BATNUM6	57
	7	BATNUM7	57
	8	BATNUM8	57
	9	BATNUM9	58
Batch Mode Output Order	*FIFO	BATLIFO	58
	LIFO	BATLIF1	58
Total Records	Total Records	BATNRC	58
Delete Last Code	Delete Last Code	BATUND	58
Clear All Codes	Clear All Codes	BATCLR	58
Transmit Records to Host	Transmit Inventory Records	BAT_TX	59
Batch Mode Transmit Delay	*Off	BATDLY0	59
	Short (250 ms)	BATDLY250	59
	Medium (500 ms)	BATDLY500	59
	Long (1000 ms)	BATDLY1000	59
Multiple Scanner Operation	Multiple Scanner Operation	BASCON2,DNG3	60
Scanner Name	Name 1-7	BT_NAM#####	60
	Reset	RESET_	61
	Scanner Name	BT_NAM	61
Application Work Group Selections	*Group 0	GRPSELO	61
	Group 1-6	GRPSEL#	61
Reset the Factory Defaults: All Application Work Groups	Factory Default Settings: All Work Groups	PAPDFT&	62
Reset the Custom Defaults: All Application Work Groups	Custom Default Settings: All Work Groups	PAPDFT	63
Bluetooth Connection	*Bluetooth SSP On	BT_SSP1	64
	Bluetooth SSP Off	BT_SSP0	64
	Bluetooth HID Keyboard Connect	PAPBTH	64
	Bluetooth HID Japanese Keyboard Connect	PAPJKB	64
	Bluetooth HID Keyboard Disconnect	PAPSPP	66
	Bluetooth Serial Port - PCs/Laptops	BT_TRM0;BT_DNG5	66
	BT Connection - PDA/Mobility Systems Device	BT_TRM0;BT_DNG1	66

Selection	Setting * Indicates default	Serial Command # Indicates a numeric entry	Page
	Bluetooth PIN Code	BT_PIN	67
Auto Reconnect Mode	*Auto Reconnect On	BT_ACM1	67
	Auto Reconnect Off	BT_ACM0	67
Maximum Link Attempts	Maximum Link Attempts	BT_MLA	68
Relink Time-Out	Relink Time-Out	BT_RLT	69
Host Command Acknowledgment	Host ACK On	HSTACK1	71
	*Host ACK Off	HSTACK0	71
	Host ACK Timeout (range 0-90) *10	HSTATO	72
Input/Output Selections			
Power Up Beeper	Power Up Beeper Off - Scanner	BEPPWRO	73
	*Power Up Beeper On - Scanner	BEPPWR1	73
	Power Up Beeper Off - Cordless Base	BASPWRO	73
	*Power Up Beeper On - Cordless Base	BASPWR1	73
Beep on BEL Character	Beep on BEL On	BELBEP1	74
	*Beep on BEL Off	BELBEPO	74
Trigger Click	On	BEPTRG1	74
	*Off	BEPTRG0	74
Beeper - Good Read	Off	BEPBEPO	74
	*On	BEPBEP1	74
Beeper Volume - Good Read	Off	BEPLVLO	74
	Low	BEPLVL1	75
	Medium	BEPLVL2	75
	*High	BEPLVL3	75
Beeper Pitch - Good Read (Frequency)	Low (1600) (min 400Hz)	BEPFQ11600	75
	*Medium (2400)	BEPFQ12400	75
	High (4200) (max 9000Hz)	BEPFQ14200	75
Beeper Pitch - Error (Frequency)	*Razz (250) (min 200Hz)	BEPFQ2250	75
	Medium (3250)	BEPFQ23250	76
	High (4200) (max 9000Hz)	BEPFQ24200	76
Beeper Duration - Good Read	*Normal Beep	BEPBIPO	76
	Short Beep	BEPBIP1	76
LED - Good Read	Off	BEPLED0	76
	*On	BEPLED1	76
Number of Beeps - Error	Range 1 - 9 (*1)	BEPERR#	77
Number of Beeps - Good Read	Range 1 - 9 (*1)	BEPRPT#	77
Good Read Delay	*No Delay	DLYGRD0	77
	Short Delay (500 ms)	DLYGRD500	77

Selection	Setting * Indicates default	Serial Command # Indicates a numeric entry	Page
	Medium Delay (1000 ms)	DLYGRD1000	77
	Long Delay (1500 ms)	DLYGRD1500	77
User-Specified Good Read Delay	Range 0 - 30,000 ms	DLYGRD#####	78
Manual Trigger Mode	*Manual Trigger - Normal	PAPHHF	78
LED Illumination - Manual Trigger	Low	PWRNOL15	78
	Medium	PWRNOL50	78
	*High	PWRNOL150	78
Serial Trigger Mode	Read Time-Out (range 0-300,000) *30,000	TRGSTO#####	79
Presentation	Presentation Mode	PAPPST	79
Triggered Presentation Mode	Ambient Light Only	PDCLED0	79
	* Ambient and Scanner Light	PDCLED1	79
Presentation Centering Window	Presentation Centering On	PDCWIN1	81
	*Presentation Centering Off	PDCWIN0	81
	Left of Presentation Centering Window (*40%)	PDCLFT###	81
	Right of Presentation Centering Window (*60%)	PDCRGT###	81
	Top of Presentation Centering Window (*40%)	PDCTOP###	81
	Bottom of Presentation Centering Window (*60%)	PDCBOT###	81
In-Stand Sensor Mode	*Sensor On	TRGSSW1	81
	Sensor Off	TRGSSW0	81
Poor Quality Codes	Poor Quality 1D Reading On	DECLDI1	82
	*Poor Quality 1D Reading Off	DECLDI0	82
	Poor Quality PDF Reading On	PDFXPR10	82
	*Poor Quality PDF Reading Off	PDFXPRO	82
CodeGate	*CodeGate Off Out-of-Stand	AOSCGD0.	83
	CodeGate On Out-of-Stand	AOSCGD1.	83
Mobile Phone Read Mode	Hand Held Scanning - Mobile Phone	PAPHHC	83
Hands Free Time-Out	Range 0 - 300,000 ms (*5000 ms)	TRGPTO#####	83
Reread Delay	Short (500 ms)	DLYRRD500	84
	*Medium (750 ms)	DLYRRD750	84
	Long (1000 ms)	DLYRRD1000	84
	Extra Long (2000 ms)	DLYRRD2000	84
User-Specified Reread Delay	Range 0 - 30,000 ms	DLYRRD#####	84

Selection	Setting * Indicates default	Serial Command # Indicates a numeric entry	Page
2D Reread Delay	*2D Reread Delay Off	DLY2RR0	84
	Short (1000ms)	DLY2RR1000	85
	Medium (2000ms)	DLY2RR2000	85
	Long (3000ms)	DLY2RR3000	85
	Extra Long (4000ms)	DLY2RR4000	85
Character Activation Mode	*Off	HSTCEN0	85
	On	HSTCEN1	85
	Activation Character	HSTACH##	85
	Do Not End Character Activation After Good Read	HSTCGD0	86
	*End Character Activation After Good Read	HSTCGD1	86
	Character Activation Timeout (Range 1 - 65525) *5000 ms	HSTCDT#####	86
Character Deactivation Mode	*Off	HSTDEN0	86
	On	HSTDEN1	86
	Deactivation Character	HSTDCH##	87
Illumination Lights	*Lights On	SCNLED1	87
	Lights Off	SCNLED0	87
Aimer Delay	200 milliseconds	SCNDLY200	87
	400 milliseconds	SCNDLY400	87
	*Off (no delay)	SCNDLY0	88
User-Specified Aimer Delay	Range 0 - 4,000 ms	SCNDLY####	88
Aimer Mode	Off	SCNAIM0	88
	On	SCNAIM3	88
	*Pulse Mode	SCNAIM5	88
Centering Window	Centering On	DECWIN1	89
	*Centering Off	DECWIN0	89
	Left of Centering Window (*40%)	DECLFT###	90
	Right of Centering Window (*60%)	DECRGT###	90
	Top of Centering Window (*40%)	DECTOP###	90
	Bottom of Centering Window (*60%)	DECBOT###	90
No Read	On	SHWNRD1	90
	*Off	SHWNRD0	90
Video Reverse	Video Reverse Only	VIDREV1	91
	Video Reverse and Standard Barcodes	VIDREV2	91
	*Video Reverse Off	VIDREVO	91
Working Orientation	*Upright	ROTATNO	92

Selection	Setting * Indicates default	Serial Command # Indicates a numeric entry	Page
	Vertical, Bottom to Top (Rotate CCW 90°)	ROTATN1	92
	Upside Down	ROTATN2	92
	Vertical, Top to Bottom (Rotate CW 90°)	ROTATN3	92
Prefix/Suffix Selections			
Add CR Suffix to All Symbologies		VSUFCR	95
Prefix	Add Prefix	PREBK2##	95
	Clear One Prefix	PRECL2	95
	Clear All Prefixes	PRECA2	95
Suffix	Add Suffix	SUFBK2##	95
	Clear One Suffix	SUFCL2	95
	Clear All Suffixes	SUFCA2	95
Function Code Transmit	*Enable	RMVFNC0	96
	Disable	RMVFNC1	96
Intercharacter Delay	Range 0 - 1000 (5ms increments)	DLYCHR##	96
User Specified Intercharacter Delay	Delay Length 0 - 1000 (5ms increments)	DLYCRX##	97
	Character to Trigger Delay	DLY_XX##	97
Interfunction Delay	Range 0 - 1000 (5ms increments)	DLYFNC##	97
Intermessage Delay	Range 0 - 1000 (5ms increments)	DLYMSG##	98
Data Formatter Selections			
Data Format Editor	*Default Data Format (None)	DFMDF3	99
	Show Data Format	DFMBK3?	100
	Enter Data Format	DFMBK3##	100
	Clear One Data Format	DFMCL3	101
	Clear All Data Formats	DFMCA3	101
Data Formatter	Data Formatter Off	DFM_EN0	111
	*Data Formatter On, Not Required, Keep Prefix/Suffix	DFM_EN1	111
	Data Format Required, Keep Prefix/Suffix	DFM_EN2	111
Primary/Alternate Data Formats	Primary Data Format	ALTFNM0	111
	Data Format 1	ALTFNM1	112
	Data Format 2	ALTFNM2	112
	Data Format 3	ALTFNM3	112
Symbologies			
All Symbologies	All Symbologies Off	ALLENA0	114
	All Symbologies On	ALLENA1	114
Codabar	Default All Codabar Settings	CBRDFT	115

Selection	Setting * Indicates default	Serial Command # Indicates a numeric entry	Page
	Off	CBRENA0	115
	*On	CBRENA1	115
Codabar Start/Stop Char.	*Don't Transmit	CBRSSX0	115
	Transmit	CBRSSX1	115
Codabar Check Char.	*No Check Char.	CBRCK20	116
	Validate, But Don't Transmit	CBRCK21	116
	Validate, and Transmit	CBRCK22	116
Codabar Concatenation	*Off	CBRCCT0	116
	On	CBRCCT1	116
	Require	CBRCCT2	116
Codabar Message Length	Minimum (2 - 60) *4	CBRMIN##	117
	Maximum (2 - 60) *60	CBRMAX##	117
Code 39	Default All Code 39 Settings	C39DFT	117
	Off	C39ENA0	117
	*On	C39ENA1	117
Code 39 Start/Stop Char.	*Don't Transmit	C39SSX0	118
	Transmit	C39SSX1	117
Code 39 Check Char.	*No Check Char.	C39CK20	118
	Validate, But Don't Transmit	C39CK21	118
	Validate, and Transmit	C39CK22	118
Code 39 Message Length	Minimum (0 - 48) *0	C39MIN##	118
	Maximum (0 - 48) *48	C39MAX##	118
Code 39 Append	*Off	C39APPO	119
	On	C39APP1	119
Code 32 Pharmaceutical (PARAF)	*Off	C39B320	119
	On	C39B321	119
Code 39 Full ASCII	*Off	C39ASC0	120
	On	C39ASC1	120
	Code 39 Code Page	C39DCP	121
Interleaved 2 of 5	Default All Interleaved 2 of 5 Settings	I25DFT	121
	Off	I25ENA0	121
	*On	I25ENA1	121
Interleaved 2 of 5 Check Digit	*No Check Digit	I25CK20	121

Selection	Setting * Indicates default	Serial Command # Indicates a numeric entry	Page
	Validate, But Don't Transmit	I25CK21	122
	Validate, and Transmit	I25CK22	122
Interleaved 2 of 5 Message Length	Minimum (2 - 80) *4	I25MIN##	122
	Maximum (2 - 80) *80	I25MAX##	122
NEC 2 of 5	Default All NEC 2 of 5 Settings	N25DFT	122
	Off	N25ENAO	122
	*On	N25ENA1	122
NEC 2 of 5 Check Digit	*No Check Char.	N25CK20	123
	Validate, But Don't Transmit	N25CK21	123
	Validate, and Transmit	N25CK22	123
NEC 2 of 5 Message Length	Minimum (2 - 80) *4	N25MIN##	123
	Maximum (2 - 80) *80	N25MAX##	123
Code 93	Default All Code 93 Settings	C93DFT	124
	Off	C93ENAO	124
	*On	C93ENA1	125
Code 93 Message Length	Minimum (0 - 80) *0	C93MIN##	124
	Maximum (0 - 80) *80	C93MAX##	124
Code 93 Append	On	C93APP1	125
	*Off	C93APP0	125
Code 93 Code Page	Code 93 Code Page	C93DCP	125
Straight 2 of 5 Industrial	Default All Straight 2 of 5 Industrial Settings	R25DFT	125
	*Off	R25ENAO	125
	On	R25ENA1	125
Straight 2 of 5 Industrial Message Length	Minimum (1 - 48) *4	R25MIN##	126
	Maximum (1 - 48) *48	R25MAX##	126
Straight 2 of 5 IATA	Default All Straight 2 of 5 IATA Settings	A25DFT	126
Straight 2 of 5 IATA	*Off	A25ENAO	126
	On	A25ENA1	126
Straight 2 of 5 IATA Message Length	Minimum (1 - 48) *4	A25MIN##	126
	Maximum (1 - 48) *48	A25MAX##	127
Matrix 2 of 5	Default All Matrix 2 of 5 Settings	X25DFT	127
	*Off	X25ENAO	127
	On	X25ENA1	127
Matrix 2 of 5 Message Length	Minimum (1 - 80) *4	X25MIN##	127
	Maximum (1 - 80) *80	X25MAX##	127
Code 11	Default All Code 11 Settings	C11DFT	128
	*Off	C11ENAO	128

Selection	Setting * Indicates default	Serial Command # Indicates a numeric entry	Page
	On	C11ENA1	128
Code 11 Check Digits Required	One Check Digit	C11CK20	128
	*Two Check Digits	C11CK21	128
Code 11 Message Length	Minimum (1 - 80) *4	C11MIN##	128
	Maximum (1 - 80) *80	C11MAX##	128
Code 128	Default All Code 128 Settings	128DFT	129
	Off	128ENAO	129
	*On	128ENA1	129
ISBT Concatenation	*Off	ISBENAO	129
	On	ISBENA1	129
Code 128 Message Length	Minimum (0 - 80) *0	128MIN##	130
	Maximum (0 - 80) *80	128MAX##	130
Code 128 Append	*On	128APP1	129
	Off	128APP0	130
Code 128 Code Page	Code 128 Code Page	128DCP##	130
GS1-128	Default All GS1-128 Settings	GS1DFT	131
	*On	GS1ENA1	131
	Off	GS1ENAO	131
GS1-128 Message Length	Minimum (1 - 80) *1	GS1MIN##	131
	Maximum (0 - 80) *80	GS1MAX##	131
UPC-A	Default All UPC-A Settings	UPADFT	132
	Off	UPBENAO	132
	*On	UPBENA1	132
UPC-A Check Digit	Off	UPACKX0	132
	*On	UPACKX1	132
UPC-A Number System	Off	UPANSX0	133
	*On	UPANSX1	132
UPC-A 2 Digit Addenda	*Off	UPAAD20	133
	On	UPAAD21	133
UPC-A 5 Digit Addenda	*Off	UPAAD50	133
	On	UPAAD51	133
UPC-A Addenda Required	*Not Required	UPAARQ0	133
	Required	UPAARQ1	133
UPC-A Addenda Separator	Off	UPAADS0	134
	*On	UPAADS1	134

Selection	Setting * Indicates default	Serial Command # Indicates a numeric entry	Page
UPC-A/EAN-13 with Extended Coupon Code	*Off	CPNENAO	134
	Allow Concatenation	CPNENA1	134
	Require Concatenation	CPNENA2	134
Coupon GS1 DataBar Output	*GS1 Output Off	CPNGS10	135
	GS1 Output On	CPNGS11	135
UPC-E0	Default All UPC-E Settings	UPEDFT	135
	Off	UPEEN00	135
	*On	UPEEN01	135
UPC-E0 Expand	*Off	UPEEXP0	136
	On	UPEEXP1	135
UPC-E0 Addenda Required	Required	UPEARQ1	136
	*Not Required	UPEARQ0	136
UPC-E0 Addenda Separator	*On	UPEADS1	136
	Off	UPEADS0	136
UPC-E0 Check Digit	Off	UPECKX0	136
	*On	UPECKX1	136
UPC-E0 Number System	Off	UPENSX0	137
	*On	UPENSX1	137
UPC-E0 Addenda	2 Digit Addenda On	UPEAD21	137
	*2 Digit Addenda Off	UPEAD20	137
	5 Digit Addenda On	UPEAD51	137
	*5 Digit Addenda Off	UPEAD50	137
UPC-E1	*Off	UPEEN10	138
	On	UPEEN11	137
EAN/JAN-13	Default All EAN/JAN Settings	E13DFT	138
	Off	E13ENAO	138
	*On	E13ENA1	138
EAN/JAN-13 Check Digit	Off	E13CKX0	139
	*On	E13CKX1	138
EAN/JAN-13 2 Digit Addenda	2 Digit Addenda On	E13AD21	139
	*2 Digit Addenda Off	E13AD20	139
	5 Digit Addenda On	E13AD51	139
	*5 Digit Addenda Off	E13AD50	139
EAN/JAN-13 Addenda Required	*Not Required	E13ARQ0	140
	Required	E13ARQ1	139
EAN/JAN-13 Addenda Separator	Off	E13ADS0	140
	*On	E13ADS1	140

Selection	Setting * Indicates default	Serial Command # Indicates a numeric entry	Page
ISBN Translate	*Off	E13ISB0	140
	On	E13ISB1	140
EAN/JAN-8	Default All EAN/JAN 8 Settings	EA8DFT	141
	Off	EA8ENAO	141
	*On	EA8ENA1	141
EAN/JAN-8 Check Digit	Off	EA8CKX0	141
	*On	EA8CKX1	141
EAN/JAN-8 Addenda	*2 Digit Addenda Off	EA8AD20	141
	2 Digit Addenda On	EA8AD21	141
	*5 Digit Addenda Off	EA8AD50	142
	5 Digit Addenda On	EA8AD51	142
EAN/JAN-8 Addenda Required	*Not Required	EA8ARQ0	142
	Required	EA8ARQ1	142
EAN/JAN-8 Addenda Separator	Off	EA8ADS0	142
	*On	EA8ADS1	142
MSI	Default All MSI Settings	MSIDFT	143
	*Off	MSIENAO	143
	On	MSIENA1	143
MSI Check Character	*Validate Type 10, but Don't Transmit	MSICHK0	143
	Validate Type 10 and Transmit	MSICHK1	143
	Validate 2 Type 10 Chars, but Don't Transmit	MSICHK2	143
	Validate 2 Type 10 Chars and Transmit	MSICHK3	144
	Validate Type 10 then Type 11 Char, but Don't Transmit	MSICHK4	144
	Validate Type 10 then Type 11 Char and Transmit	MSICHK5	144
	Disable MSI Check Characters	MSICHK6	144
MSI Message Length	Minimum (4 - 48) *4	MSIMIN##	144
	Maximum (4 - 48) *48	MSIMAX##	144
GS1 DataBar Omnidirectional	Default All GS1 DataBar Omnidirectional Settings	RSSDFT	144
	Off	RSENAO	144
	*On	RSENA1	144
GS1 DataBar Limited	Default All GS1 DataBar Limited Settings	RSLDFT	145
	Off	RSLENAO	145
	*On	RSLENA1	145

Selection	Setting * Indicates default	Serial Command # Indicates a numeric entry	Page
GS1 DataBar Expanded	Default All GS1 DataBar Expanded Settings	RSEDFT	145
	Off	RSEENAO	145
	*On	RSEENA1	145
GS1 DataBar Expanded Msg. Length	Minimum (4 - 74) *4	RSEMIN##	146
	Maximum (4 - 74) *74	RSEMAX##	146
Codablock A	Default All Codablock A Settings	CBADFT	146
	*Off	CBAENAO	146
	On	CBAENA1	146
Codablock A Msg. Length	Minimum (1 - 600) *1	CBAMIN####	146
	Maximum (1 - 600) *600	CBAMAX####	147
Codablock F	Default All Codablock F Settings	CBFDFT	147
	*Off	CBFENAO	147
	On	CBFENA1	147
Codablock F Msg. Length	Minimum (1 - 2048) *1	CBFMIN####	147
	Maximum (1 - 2048) *2048	CBFMAX####	147
PDF417	Default All PDF417 Settings	PDFDFT	148
	*On	PDFENA1	148
	Off	PDFENAO	148
PDF417 Msg. Length	Minimum (1-2750) *1	PDFMIN####	148
	Maximum (1-2750) *2750	PDFMAX####	148
MacroPDF417	*On	PDFMAC1	148
	Off	PDFMAC0	149
MicroPDF417	Default All Micro PDF417 Settings	MPDDFT	149
	On	MPDENA1	149
	*Off	MPDENA0	149
MicroPDF417 Msg. Length	Minimum (1-366) *1	MPDMIN###	149
	Maximum (1-366) *366	MPDMAX###	149
GS1 Composite Codes	On	COMENA1	150
	*Off	COMENAO	150
UPC/EAN Version	On	COMUPC1	150
	*Off	COMUPC0	150
GS1 Composite Codes Msg. Length	Minimum (1-2435) *1	COMMIN####	150
	Maximum (1-2435) *2435	COMMAX####	150
GS1 Emulation	GS1-128 Emulation	EANEMU1	151
	GS1 DataBar Emulation	EANEMU2	151
	GS1 Code Expansion Off	EANEMU3	151

Selection	Setting * Indicates default	Serial Command # Indicates a numeric entry	Page
	EAN8 to EAN13 Conversion	EANEMU4	151
	*GS1 Emulation Off	EANEMU0	151
TCIF Linked Code 39	On	T39ENA1	152
	*Off	T39ENA0	152
QR Code	Default All QR Code Settings	QRCDFT	158
	*On	QRCENA1	152
	Off	QRCENA0	152
QR Code Msg. Length	Minimum (1-7089) *1	QRCMIN####	153
	Maximum (1-7089) *7089	QRCMAX####	153
QR Code Append	*One Scan	QRCAPP1	153
	Swipe	QRCAPP2	153
	Point and Shoot	QRCAPP3	153
	Off	QRCAPP0	154
QR Code Page	QR Code Page	QRCDCP##	154
Data Matrix	Default All Data Matrix Settings	IDMDFT	154
	*On	IDMENA1	154
	Off	IDMENA0	154
Data Matrix Msg. Length	Minimum (1-3116) *1	IDMMIN####	155
	Maximum (1-3116) *3116	IDMMAX####	155
Data Matrix Code Page	Data Matrix Code Page	IDMDCP##	155
MaxiCode	Default All MaxiCode Settings	MAXDFT	155
	On	MAXENA1	155
	*Off	MAXENA0	155
MaxiCode Msg. Length	Minimum (1-150) *1	MAXMIN###	156
	Maximum (1-150) *150	MAXMAX###	156
Aztec Code	Default All Aztec Code Settings	AZTDFT	156
	*On	AZTENA1	156
	Off	AZTENA0	156
Aztec Code Msg. Length	Minimum (1-3832) *1	AZTMIN####	156
	Maximum (1-3832) *3832	AZTMAX####	157
Aztec Append	*One Scan	AZTAPP1	157
	Swipe	AZTAPP2	157
	Point and Shoot	AZTAPP3	157
	Off	AZTAPP0	157
Aztec Code Page	Aztec Code Page	AZTDCP##	158

Selection	Setting * Indicates default	Serial Command # Indicates a numeric entry	Page
Chinese Sensible (Han Xin) Code	Default All Han Xin Code Settings	HX_DFT	158
	On	HX_ENA1	158
	*Off	HX_ENA0	158
Chinese Sensible (Han Xin) Code Msg. Length	Minimum (1-7833) *1	HX_MIN####	158
	Maximum (1-7833) *7833	HX_MAX####	158
Postal Codes - 2D			
2D Postal Codes	*Off	POSTAL0	165
Single 2D Postal Codes	Australian Post On	POSTAL1	159
	British Post On	POSTAL7	159
	Canadian Post On	POSTAL30	159
	Intelligent Mail Barcode On	POSTAL10	159
	Japanese Post On	POSTAL3	159
	KIX Post On	POSTAL4	159
	Planet Code On	POSTAL5	159
	Postal-4i On	POSTAL9	159
	Postnet On	POSTAL6	160
	Postnet with B and B' Fields On	POSTAL11	160
	InfoMail On	POSTAL2	160
Combination 2D Postal Codes	InfoMail and British Post On	POSTAL8	160
	Intelligent Mail Barcode and Postnet with B and B' Fields On	POSTAL20	160
	Postnet and Postal-4i On	POSTAL14	160
	Postnet and Intelligent Mail Barcode On	POSTAL16	160
	Postal-4i and Intelligent Mail Barcode On	POSTAL17	160
	Postal-4i and Postnet with B and B' Fields On	POSTAL19	160
	Planet and Postnet On	POSTAL12	161
	Planet and Postnet with B and B' Fields On	POSTAL18	161
	Planet and Postal-4i On	POSTAL13	161
	Planet and Intelligent Mail Barcode On	POSTAL15	161
	Planet, Postnet, and Postal-4i On	POSTAL21	161
	Planet, Postnet, and Intelligent Mail Barcode On	POSTAL22	161
	Planet, Postal-4i, and Intelligent Mail Barcode On	POSTAL23	161
	Postnet, Postal-4i, and Intelligent Mail Barcode On	POSTAL24	161
Planet, Postal-4i, and Postnet with B and B' Fields On	POSTAL25	161	

Selection	Setting * Indicates default	Serial Command # Indicates a numeric entry	Page
	Planet, Intelligent Mail Barcode, and Postnet with B and B' Fields On	POSTAL26	161
	Postal-4i, Intelligent Mail Barcode, and Postnet with B and B' Fields On	POSTAL27	162
	Planet, Postal-4i, Intelligent Mail Barcode, and Postnet On	POSTAL28	162
	Planet, Postal-4i, Intelligent Mail Barcode, and Postnet with B and B' Fields On	POSTAL29	162
Planet Code Check Digit	Transmit	PLNCKX1	162
	*Don't Transmit	PLNCKX0	162
Postnet Check Digit	Transmit	NETCKX1	162
	*Don't Transmit	NETCKX0	162
Australian Post Interpretation	Bar Output	AUSINT0	163
	Numeric N Table	AUSINT1	163
	Alphanumeric C Table	AUSINT2	163
	Combination N and C Tables	AUSINT3	163
Postal Codes - Linear			
China Post (Hong Kong 2 of 5)	Default All China Post (Hong Kong 2 of 5) Settings	CPCDFT	163
	*Off	CPCENAO	164
	On	CPCENA1	164
China Post (Hong Kong 2 of 5) Msg. Length	Minimum (2 - 80) *4	CPCMIN##	164
	Maximum (2 - 80) *80	CPCMAX##	164
Korea Post	Default All Korea Post Settings	KPCDFT	164
	*Off	KPCENAO	164
	On	KPCENA1	164
Korea Post Msg. Length	Minimum (2 - 80) *4	KPCMIN##	165
	Maximum (2 - 80) *48	KPCMAX##	165
Korea Post Check Digit	Transmit Check Digit	KPCCHK1	165
	*Don't Transmit Check Digit	KPCCHK0	165
Utilities			
Add Code I.D. Prefix to All Symbolologies (Temporary)		PRECA2,BK2995C80!	167
Show Decoder Library Version		REV_AD	167
Show Software Revision		REVINF	167
Test Menu	On	TSTMNU1	168
	*Off	TSTMNU0	168
Reset the Factory Defaults	Remove Custom Defaults	DEFOVR	169
	Activate Defaults	DEFALT	169

Voyager XP 1470g Scanner Product Specifications

Parameter	Specification
Mechanical	
Height	3.23 in. (82mm)
Length	2.45 in. (62mm)
Width	6.65 in. (169mm)
Weight	4.6 oz. (130g)
Electrical	
Input Voltage	4.0 - 5.5VDC
Operating Power	2W (400mA @ 5VDC)
Standby Power	.45W (90mA @ 5VDC)
Illumination	White color (CCT 2700K)
Aiming	Red color, 624nm peak wavelength
Environmental	
Operating Temperature	32°F to 122°F (0°C to 50°C)
Storage Temperature	-40°F to 140°F (-40°C to 60°C)
Humidity	5 to 95% non-condensing
Drop	Operational after 30 drops to concrete from 5.9 ft. (1.8m)
Environmental Sealing	IP52
Light Levels	0 to 100,000 lux (9,290 foot-candles)
ESD	15kV Air, 8kV contact

Parameter	Specification
Image	
Image Size	1040 x 720 pixels
Scan Performance	
Pitch, Skew	± 65°, ± 70°
Motion Tolerance: Presentation Mode	up to 70cm per second for 13 mil UPC
Print Contrast	20%

Voyager XP 1472g Cordless Scanner Product Specifications

Parameter	Specification
Mechanical	
Height	6.8 in. (17.3cm)
Length	3.2 in. (8.2cm)
Width	2.5 in. (6.2cm)
Weight	7.3 oz. (210g)
Electrical	
Battery: Lithium Ion	2400 mAH lithium-ion
Number of Scans	Up to 50,000 per charge
Expected Hours of Operation	14
Expected Charge Time	4.5 hours
Illumination	White color (CCT 2700K)
Aiming	Red color, 624nm peak wavelength
Radio	
Frequency	2.4 to 2.5 GHz (ISM Band) Frequency Hopping Bluetooth v.4.2
Range	33 ft. (10 m) typical
Data Rate	Up to 1 MBps
Environmental	
Operating Temperature	32° F to 122° F (0° C to 50° C)
Storage Temperature (with battery)	-4°F to 95°F (-20°C to 35°C) storage for 90 days -4°F to 68°F (-20°C to 20°C) storage for 1 year
Storage Temperature (without battery)	-40° F to 140° F (-40° C to 60° C)
Humidity	Up to 95% non-condensing
Drop	Operational after 30 drops to concrete from 5.9 ft. (1.8 m)
Environmental Sealing	IP52

Parameter	Specification
Vibration	Withstands 5G peak from 5 to 300 Hz
ESD	12kV Air, 8kV contact
Image	
Image Size	1040 x 720 pixels
Scan Performance	
Pitch, Skew	± 65°, ± 70°
Motion Tolerance: Presentation Mode	up to 70cm per second for 13 mil UPC
Print Contrast	20%

*Storage outside of this temperature range could be detrimental to battery life.

CCB01-010BT-V1N Charge Base Product Specifications

Parameter	Specification
Dimensions (Typical):	
Height	3.2 inches (8.13cm)
Length	5.19 inches (13.18cm)
Width	3.98 inches (10.11cm)
Weight	6.3 oz (179g)
Voltage:	4.5 to 5.5 volts
Current Draw:	
Host Terminal Port	500mA
Aux Power Port	1A
Charge Time	5 hours
Radio:	
Frequency	2.4 to 2.5 GHz (ISM Band) Frequency Hopping Bluetooth v.4.2
Range	33 ft. (10 m) typical
Data Rate	Up to 1 MBps
Temperature Ranges:	
Operating	32° F to +122° F (0° C to +50° C)
Battery Charge	41° F to +104° F (5° C to +40° C)
Storage	-40° F to +158° F (-40° C to +70° C)
Humidity	Up to 95% non-condensing

(Continued)Parameter	Specification
Mechanical Drop	Operational after 50 drops from 3.28 feet (1 m) to concrete
Vibration	5G Peak from 22Hz to 300Hz
ESD Sensitivity	Up to 15kV direct air Up to 8 kV indirect coupling plane
Sealant Rating	IP41

Depth of Field Charts

Typical Performance

Focus			
Symbology		Near Distance	Far Distance
5 mil Code 39	in.	.8	8.1
	mm	20	205
10 mil Code 39	in.	.2	14.4
	mm	5	365
13 mil UPC-A	in.	.7	15.7
	mm	18	400
20 mil Code 39	in.	1	24.2
	mm	25	615
6.7 mil PDF417	in.	.6	7.3
	mm	15	185
10 mil PDF417	in.	.8	11
	mm	20	280
10 mil Data Matrix	in.	.4	6.5
	mm	10	165
10 mil QR Code	in.	.2	6.9
	mm	5	175
20 mil QR Code	in.	.2	12.8
	mm	5	325
NYS DL	in.	3.1	8.7
	mm	80	220

Resolution (Code 39)	3 mil	0.076 mm
Resolution (PDF417)	4 mil	0.102 mm
Resolution (QR)	6 mil	0.152 mm
Resolution (DM)	5 mil	0.127 mm

Guaranteed Performance

Focus			
Symbology		Near Distance	Far Distance
5 mil Code 39	in.	1	7.9
	mm	25	200
10 mil Code 39	in.	.2	13
	mm	5	330
13 mil UPC-A	in.	.8	14.6
	mm	20	370
20 mil Code 39	in.	1.2	17.9
	mm	30	455
6.7 mil PDF417	in.	1	6.9
	mm	25	175
10 mil PDF417	in.	1	10.2
	mm	25	260
10 mil Data Matrix	in.	.6	6.1
	mm	15	155
10 mil QR Code	in.	.4	6.3
	mm	10	160
20 mil QR Code	in.	.4	12
	mm	10	305
NYS DL	in.	3.1	7.9
	mm	80	200

Standard Cable Pinouts

Note: *The following pin assignments are not compatible with Honeywell legacy products. Use of a cable with improper pin assignments may lead to damage to the unit. Use of any cables not provided by the manufacturer may result in damage not covered by your warranty.*

Keyboard Wedge

10 Pin RJ41 Modular Plug

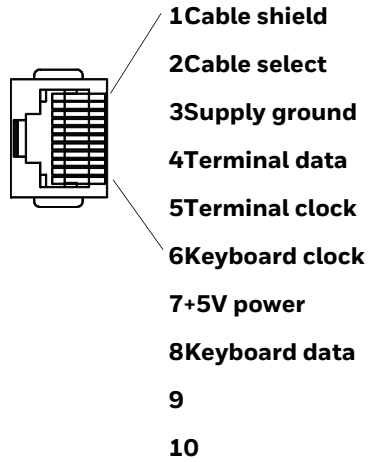

Serial Output

10 Pin RJ41 Modular Plug

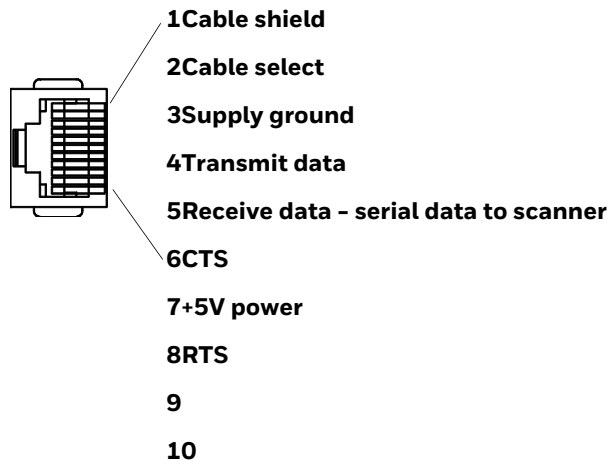

USB

10 Pin Modular Plug

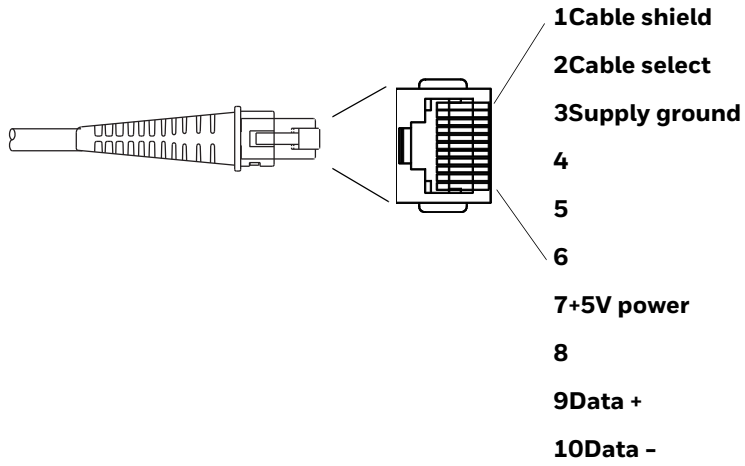

RS485 Output

10 Pin RJ41 Modular Plug

Note: RS485 signal conversion is performed in the cable.

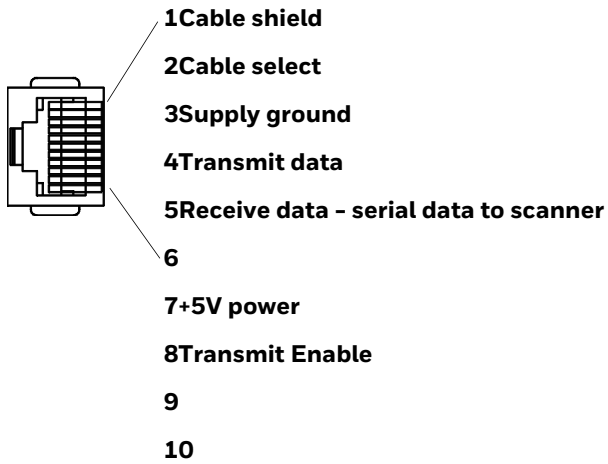

Required Safety Labels

Voyager XP 1470g/1472g Scanner

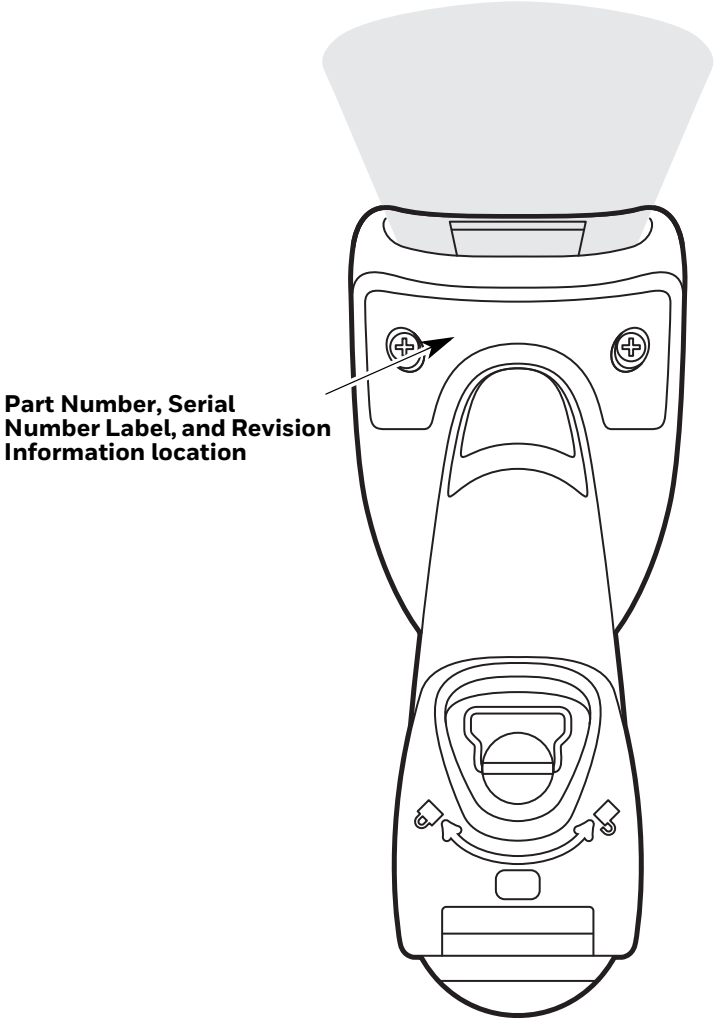

Part Number, Serial Number Label, and Revision Information location

CCB01-010BT-V1N Base

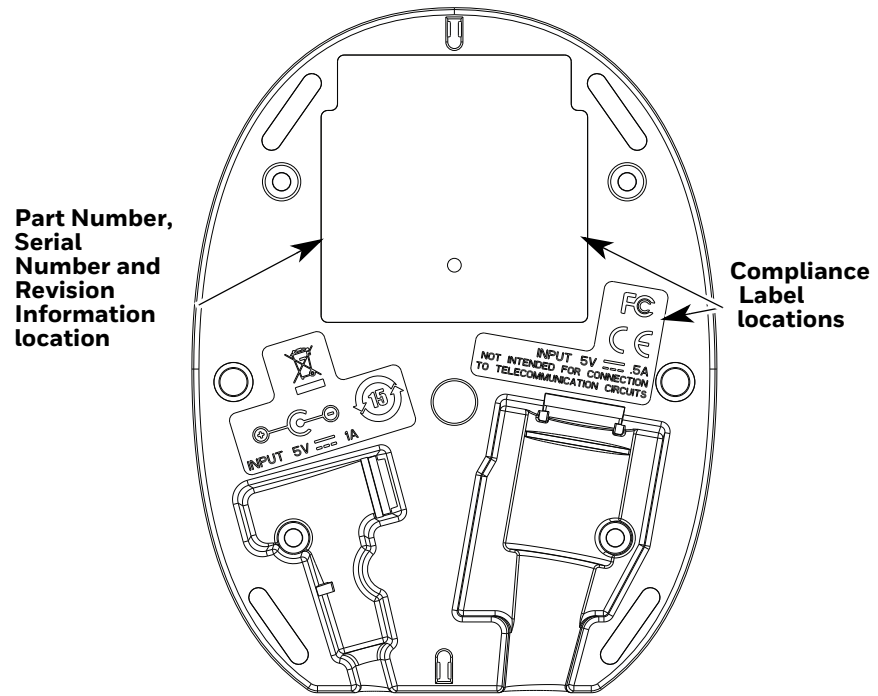

MAINTENANCE AND TROUBLESHOOTING

Repairs

Repairs and/or upgrades are not to be performed on this product. These services are to be performed only by an authorized service center (see [Customer Support](#) on page xv).

Maintenance

Your device provides reliable and efficient operation with a minimum of care. Although specific maintenance is not required, the following sections describe periodic checks to ensure dependable operation.

Clean the Scanner

The scanner or base's housing may be cleaned with a soft cloth dampened with water or a mild detergent-water solution. If a mild detergent solution is used, wipe the scanner or base with a clean cloth dampened only with water to remove any detergent residue.



Caution: Do not submerge the scanner in water. Do not use abrasive wipes or cloths on the scanner's window. Abrasive wipes may scratch the window. Never use solvents (e.g., acetone) on the housing or window. Solvents may damage the finish or the window.

Caution: Ensure all components are dry prior to mating the scanner with charging accessories or other peripheral devices. Mating wet components may cause damage not covered by the warranty.

Clean the Window

Reading performance may degrade if the scanner's window is not clean. If the window is visibly dirty, or if the scanner isn't operating well, clean the window with soft cloth dampened with water.



Caution: Do not use abrasive wipes or cloths on the scanner's window. Abrasive wipes may scratch the window. Never use solvents (e.g., acetone) on the window. Solvents may damage the window.

About Disinfectant-ready Models

Some configurations of Voyager XP scanners are available with an external plastic housing that is designed to resist the effects of harsh chemicals. These scanners are equipped with disinfectant-ready housings (DRH) for the healthcare and general-purpose markets.

Please refer to the Honeywell Safety and Productivity Solutions website for specific details on how to clean Voyager XP scanners with disinfectant-ready housings. Helpful information on the care of these specialty products can be found in the following articles:

- [Learn to Clean Honeywell Healthcare Disinfectant-ready Products](#)
- [Honeywell Instructions for Cleaning General Purpose Disinfectant-ready Housing Devices](#)
- [Disinfectant-Ready Application Brief](#)

Inspect Cords and Connectors

Inspect the interface cable and connector for wear or other signs of damage. A badly worn cable or damaged connector may interfere with scanner operation. Contact your distributor for information about cable replacement. Cable replacement instructions are on [page 208](#).

Replace Cables in Corded Scanners

The standard interface cable is attached to the scanner with an 10-pin modular connector. When properly seated, the connector is held in the scanner's handle by a flexible retention tab. The interface cable is designed to be field replaceable.

- Order replacement cables from Honeywell or from an authorized distributor.
- When ordering a replacement cable, specify the cable part number of the original interface cable.

Replace a Corded Scanner Interface Cable

1. Turn the power to the host system OFF.
2. Disconnect the scanner's cable from the terminal or computer.
3. Locate the small hole on the back of the scanner's handle. This is the cable release.
4. Straighten one end of a paper clip.
5. Insert the end of the paper clip into the small hole and press in. This depresses the retention tab, releasing the connector. Pull the connector out while maintaining pressure on the paper clip, then remove the paper clip.
6. Replace with the new cable.
Insert the connector into the opening and press firmly. The connector is keyed to go in only one way, and will click into place.

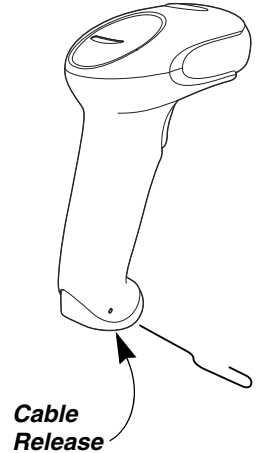

Replace Cables and Batteries in Cordless Systems

Replace an Interface Cable in a Base

1. Turn the power to the host system OFF.
2. Disconnect the base's cable from the terminal or computer.
3. Turn the base upside down.
4. Pull the connector out while maintaining pressure on the connector release clip.

CCB01-010BT-V1N Base:

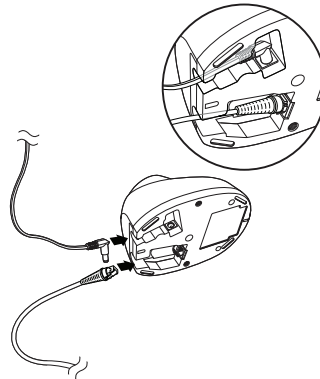

5. Replace with the new cable.
Insert the connector into the opening and press firmly. The connector is keyed to go in only one way, and will click into place.

Change a Cordless Scanner Battery

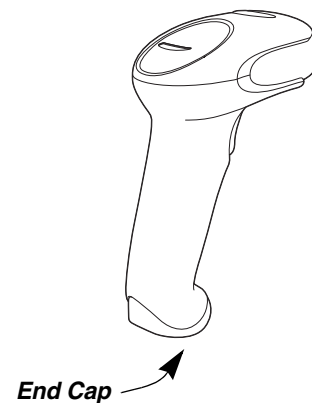

1. Use the hinged wire or a flat head screwdriver to remove the screw from the end cap.
2. Remove the end cap and remove the battery from the handle.
3. Insert replacement battery.
4. Replace end cap and screw it back on.

Troubleshoot a Corded Scanner

The scanner automatically performs self-tests whenever you turn it on. If your scanner is not functioning properly, review the following Troubleshooting Guide to try to isolate the problem.

Is the power on? Is the aimer on?

If the aimer isn't illuminated, check that:

- The cable is connected properly.
- The host system power is on (if external power isn't used).
- The trigger works.

Is the scanner having trouble reading your symbols?

If the scanner isn't reading symbols well, check that the symbols:

- Aren't smeared, rough, scratched, or exhibiting voids.
- Aren't coated with frost or water droplets on the surface.
- Are enabled in the scanner or in the decoder to which the scanner connects.

Is the barcode displayed but not entered?

The barcode is displayed on the host device correctly, but you still have to press a key to enter it (the Enter/Return key or the Tab key, for example).

- You need to program a suffix. Programming a suffix enables the scanner to output the barcode data plus the key you need (such as "CR") to enter the data

into your application. Refer to [Prefix/Suffix Overview](#) beginning on page 93 for further information.

If you aren't sure what programming options have been set in the scanner, or if you want the factory default settings restored, refer to [Reset the Custom Defaults](#) on page 175.

Troubleshoot a Cordless System

Troubleshoot a Base

Note: Visit the *Services and Support* section of our website (sps.honeywell.com) to check for the latest software for both the scanner and the base.

If your base is not functioning properly, review the following troubleshooting guidelines to try to isolate the problem.

Is the red LED on?

If the red LED isn't illuminated, check that:

- The power cable is connected properly and there is power at the power source.
- The host system power is on (if external power isn't used).

Is the green LED on?

If the green LED isn't illuminated, check that:

- The scanner is correctly placed in the base.
- There is external power or 12 volt host power.
- Charge mode is turned on. (See "[Beeper and LED Sequences and Meaning](#)" on page 43)
- The battery is not bad or deeply discharged. In some cases, the scanner's battery may trickle charge to bring it into an acceptable level and then transition to a normal charge cycle.

Troubleshoot a Cordless Scanner

Note: Make sure that your scanner's battery is charged. Visit the *Services and Support* section of our website (sps.honeywell.com) to check for the latest software for both the scanner and the base or Access Point.

Is the scanner having trouble reading your symbols?

If the scanner isn't reading symbols well, check that the symbols:

- Aren't smeared, rough, scratched, or exhibiting voids.
- Aren't coated with frost or water droplets on the surface.

- Are enabled in the base or Access Point to which the scanner connects.

Is the barcode displayed but not entered into the application?

The barcode is displayed on the host device correctly, but you still have to press a key to enter it (the Enter/Return key or the Tab key, for example).

- You need to program a suffix. Programming a suffix enables the scanner to output the barcode data plus the key you need (such as “CR”) to enter the data into your application. Refer to [Prefix/Suffix Overview](#) on page 93 for further information.

The scanner won’t read your barcode at all.

- Scan the sample barcodes in the back of this manual. If the scanner reads the sample barcodes, check that your barcode is readable.

Verify that your barcode symbology is enabled (see [Chapter 7](#)).

REFERENCE CHARTS

Symbology Charts

Note: “m” represents the AIM modifier character. Refer to *International Technical Specification, Symbology Identifiers*, for AIM modifier character details.

Prefix/Suffix entries for specific symbologies override the universal (*All Symbologies*, 99) entry.

Refer to [Data Edit](#) beginning on page 93 and [Data Format](#) beginning on page 99 for information about using Code ID and AIM ID.

Linear Symbologies

Symbology	AIM		Honeywell	
	ID	Possible modifiers (m)	ID	Hex
<i>All Symbologies</i>				99
Codabar	JFm	0-1	a	61
Code 11	JH3		h	68
Code 128	JCm	0, 1, 2, 4	j	6A
Code 32 Pharmaceutical (PARAF)	JX0		<	3C
Code 39 (supports Full ASCII mode)	JAm	0, 1, 3, 4, 5, 7	b	62
TCIF Linked Code 39 (TLC39)	JL2		T	54
Code 93 and 93i	JGm	0-9, A-Z, a-m	i	69
EAN	JEm	0, 1, 3, 4	d	64
EAN-13 (including Bookland EAN)	JE0		d	64
EAN-13 with Add-On	JE3		d	64
EAN-13 with Extended Coupon Code	JE3		d	64
EAN-8	JE4		D	44

Symbology	AIM		Honeywell	
	ID	Possible modifiers (m)	ID	Hex
EAN-8 with Add-On	JE3		D	44
GS1				
GS1 DataBar	jem	0	y	79
GS1 DataBar Limited	jem		{	7B
GS1 DataBar Expanded	jem		}	7D
GS1-128	JC1		l	49
2 of 5				
China Post (Hong Kong 2 of 5)	JX0		Q	51
Interleaved 2 of 5	Jlm	0, 1, 3	e	65
Matrix 2 of 5	JX0		m	6D
NEC 2 of 5	JX0		Y	59
Straight 2 of 5 IATA	JRm	0, 1, 3	f	66
Straight 2 of 5 Industrial	JS0		f	66
MSI	JMm	0, 1	g	67
Telepen	JBm		t	74
UPC		0, 1, 2, 3, 8, 9, A, B, C		
UPC-A	JE0		c	63
UPC-A with Add-On	JE3		c	63
UPC-A with Extended Coupon Code	JE3		c	63
UPC-E	JE0		E	45
UPC-E with Add-On	JE3		E	45
UPC-E1	JX0		E	45

Add Honeywell Code ID				5C80
Add AIM Code ID				5C81
Add Backslash				5C5C
Batch mode quantity			5	35

2D Symbologies

Symbology	AIM		Honeywell	
	ID	Possible modifiers (m)	ID	Hex
All Symbologies				99
Aztec Code]zm	0-9, A-C	z	7A

Symbology	AIM		Honeywell	
	ID	Possible modifiers (m)	ID	Hex
Chinese Sensible Code (Han Xin Code)]X0		H	48
Codablock A]06	0, 1, 4, 5, 6	V	56
Codablock F]0m	0, 1, 4, 5, 6	q	71
Code 49]Tm	0, 1, 2, 4	l	6C
Data Matrix]dm	0-6	w	77
GS1]em	0-3	y	79
GS1 Composite]em	0-3	y	79
GS1 DataBar Omnidirectional]em	0-3	y	79
MaxiCode]Um	0-3	x	78
PDF417]Lm	0-2	r	72
MicroPDF417]Lm	0-5	R	52
QR Code]Qm	0-6	s	73
Micro QR Code]Qm		s	73

Postal Symbologies

Symbology	AIM		Honeywell	
	ID	Possible modifiers (m)	ID	Hex
All Symbologies				99
Australian Post]X0		A	41
British Post]X0		B	42
Canadian Post]X0		C	43
China Post]X0		Q	51
InfoMail]X0		,	2c
Intelligent Mail Barcode]X0		M	4D
Japanese Post]X0		J	4A
KIX (Netherlands) Post]X0		K	4B
Korea Post]X0		?	3F
Planet Code]X0		L	4C
Postal-4i]X0		N	4E
Postnet]X0		P	50

ASCII Conversion Chart (Code Page 1252)

In keyboard applications, ASCII Control Characters can be represented in 3 different ways, as shown below. The CTRL+X function is OS and application dependent. The following table lists some commonly used Microsoft functionality. This table applies to U.S. style keyboards. Certain characters may differ depending on your Country Code/PC regional settings.

Non-printable ASCII control characters			Keyboard Control + ASCII (CTRL+X) Mode		
DEC	HEX	Char	Control + X Mode Off (KBDCAS0)	Windows Mode Control + X Mode On (KBDCAS2)	
				CTRL + X	CTRL + X function
0	00	NUL	Reserved	CTRL+ @	
1	01	SOH	NP Enter	CTRL+ A	Select all
2	02	STX	Caps Lock	CTRL+ B	Bold
3	03	ETX	ALT Make	CTRL+ C	Copy
4	04	EOT	ALT Break	CTRL+ D	Bookmark
5	05	ENQ	CTRL Make	CTRL+ E	Center
6	06	ACK	CTRL Break	CTRL+ F	Find
7	07	BEL	Enter / Ret	CTRL+ G	
8	08	BS	<i>(Apple Make)</i>	CTRL+ H	History
9	09	HT	Tab	CTRL+ I	Italic
10	0A	LF	<i>(Apple Break)</i>	CTRL+ J	Justify
11	0B	VT	Tab	CTRL+ K	hyperlink
12	0C	FF	Delete	CTRL+ L	list, left align
13	0D	CR	Enter / Ret	CTRL+ M	
14	0E	SO	Insert	CTRL+ N	New
15	0F	SI	ESC	CTRL+ O	Open
16	10	DLE	F11	CTRL+ P	Print
17	11	DC1	Home	CTRL+ Q	Quit
18	12	DC2	PrtScn	CTRL+ R	
19	13	DC3	Backspace	CTRL+ S	Save
20	14	DC4	Back Tab	CTRL+ T	
21	15	NAK	F12	CTRL+ U	
22	16	SYN	F1	CTRL+ V	Paste
23	17	ETB	F2	CTRL+ W	
24	18	CAN	F3	CTRL+ X	
25	19	EM	F4	CTRL+ Y	?
26	1A	SUB	F5	CTRL+ Z	?
27	1B	ESC	F6	CTRL+ [?
28	1C	FS	F7	CTRL+ \	?
29	1D	GS	F8	CTRL+]	?
30	1E	RS	F9	CTRL+ ^	?
31	1F	US	F10	CTRL+ -	?
127	7F	△	NP Enter		?

Lower ASCII Reference Table

Note: Windows Code page 1252 and lower ASCII use the same characters.

Printable Characters								
DEC	HEX	Character	DEC	HEX	Character	DEC	HEX	Character
32	20	<SPACE>	64	40	@	96	60	`
33	21	!	65	41	A	97	61	a
34	22	"	66	42	B	98	62	b
35	23	#	67	43	C	99	63	c
36	24	\$	68	44	D	100	64	d
37	25	%	69	45	E	101	65	e
38	26	&	70	46	F	102	66	f
39	27	'	71	47	G	103	67	g
40	28	(72	48	H	104	68	h
41	29)	73	49	I	105	69	i
42	2A	*	74	4A	J	106	6A	j
43	2B	+	75	4B	K	107	6B	k
44	2C	,	76	4C	L	108	6C	l
45	2D	-	77	4D	M	109	6D	m
46	2E	.	78	4E	N	110	6E	n
47	2F	/	79	4F	O	111	6F	o
48	30	0	80	50	P	112	70	p
49	31	1	81	51	Q	113	71	q
50	32	2	82	52	R	114	72	r
51	33	3	83	53	S	115	73	s
52	34	4	84	54	T	116	74	t
53	35	5	85	55	U	117	75	u
54	36	6	86	56	V	118	76	v
55	37	7	87	57	W	119	77	w
56	38	8	88	58	X	120	78	x
57	39	9	89	59	Y	121	79	y
58	3A	:	90	5A	Z	122	7A	z
59	3B	;	91	5B	[123	7B	{
60	3C	<	92	5C	\	124	7C	
61	3D	=	93	5D]	125	7D	}
62	3E	>	94	5E	^	126	7E	~
63	3F	?	95	5F	_	127	7F	△

Extended ASCII Characters					
DEC	HEX	CP 1252	ASCII	Alternate Extended	PS2 Scan Code
128	80	€	Ç	up arrow ↑	0x48
129	81		ü	down arrow ↓	0x50
130	82	,	é	right arrow →	0x4B
131	83	f	â	left arrow ←	0x4D
132	84	„	ä	Insert	0x52
133	85	…	à	Delete	0x53
134	86	†	å	Home	0x47
135	87	‡	ç	End	0x4F
136	88	^	ê	Page Up	0x49
137	89	‰	ë	Page Down	0x51
138	8A	Š	è	Right ALT	0x38
139	8B	<	ï	Right CTRL	0x1D

Extended ASCII Characters (Continued)

DEC	HEX	CP 1252	ASCII	Alternate Extended	PS2 Scan Code
140	8C	Œ	î	Reserved	n/a
141	8D		ï	Reserved	n/a
142	8E	Ž	Ā	Numeric Keypad Enter	0x1C
143	8F		Ă	Numeric Keypad /	0x35
144	90		É	F1	0x3B
145	91	‘	æ	F2	0x3C
146	92	’	Æ	F3	0x3D
147	93	“	ô	F4	0x3E
148	94	”	ö	F5	0x3F
149	95	•	ò	F6	0x40
150	96	–	û	F7	0x41
151	97	—	ù	F8	0x42
152	98	˜	ÿ	F9	0x43
153	99	™	Ö	F10	0x44
154	9A	š	Ü	F11	0x57
155	9B	›	ç	F12	0x58
156	9C	œ	£	Numeric Keypad +	0x4E
157	9D		¥	Numeric Keypad -	0x4A
158	9E	ž	Ps	Numeric Keypad *	0x37
159	9F	ÿ	f	Caps Lock	0x3A
160	A0		á	Num Lock	0x45
161	A1	ı	í	Left Alt	0x38
162	A2	ç	ó	Left Ctrl	0x1D
163	A3	£	ú	Left Shift	0x2A
164	A4	¤	ñ	Right Shift	0x36
165	A5	¥	Ñ	Print Screen	n/a
166	A6	ı	ª	Tab	0x0F
167	A7	§	º	Shift Tab	0x8F
168	A8	¨	¿	Enter	0x1C
169	A9	©	ƒ	Esc	0x01
170	AA	ª	¬	Alt Make	0x36
171	AB	«	½	Alt Break	0xB6
172	AC	¬	¼	Control Make	0x1D
173	AD		ı	Control Break	0x9D
174	AE	®	«	Alt Sequence with 1 Character	0x36
175	AF	™	»	Ctrl Sequence with 1 Character	0x1D
176	B0	°	␣		
177	B1	±	␣		
178	B2	²	␣		
179	B3	³	␣		
180	B4	´	␣		
181	B5	µ	␣		
182	B6	¶	␣		
183	B7	·	␣		
184	B8	¸	␣		
185	B9	¹	␣		
186	BA	º	␣		
187	BB	»	␣		
188	BC	¼	␣		
189	BD	½	␣		
190	BE	¾	␣		
191	BF	¿	␣		
192	C0	À	␣		
193	C1	Á	␣		

Extended ASCII Characters (Continued)					
DEC	HEX	CP 1252	ASCII	Alternate Extended	PS2 Scan Code
194	C2	Â	T		
195	C3	Ã	†		
196	C4	Ä	—		
197	C5	Å	í		
198	C6	Æ	ƒ		
199	C7	Ç	‡		
200	C8	È	ℓ		
201	C9	É	ƒ		
202	CA	Ê	≡		
203	CB	Ë	ƒ		
204	CC	Ì	‡		
205	CD	Í	=		
206	CE	Î	‡		
207	CF	Ï	≡		
208	D0	Ð	≡		
209	D1	Ñ	ƒ		
210	D2	Ò	≡		
211	D3	Ó	ℓ		
212	D4	Ô	ℓ		
213	D5	Õ	F		
214	D6	Ö	ƒ		
215	D7	×	‡		
216	D8	Ø	†		
217	D9	Ù	J		
218	DA	Ú	ƒ		
219	DB	Û	■		
220	DC	Ü	■		
221	DD	Ý	■		
222	DE	Þ	■		
223	DF	ß	■		
224	E0	à	α		
225	E1	á	β		
226	E2	â	Γ		
227	E3	ã	π		
228	E4	ä	Σ		
229	E5	å	σ		
230	E6	æ	μ		
231	E7	ç	τ		
232	E8	è	Φ		
233	E9	é	Θ		
234	EA	ê	Ω		
235	EB	ë	δ		
236	EC	ì	∞		
237	ED	í	φ		
238	EE	î	ε		
239	EF	ï	∩		
240	F0	ð	≡		
241	F1	ñ	±		
242	F2	ò	≥		
243	F3	ó	≤		
244	F4	ô			
245	F5	õ]		
246	F6	ö	+		
247	F7	÷	≈		

Extended ASCII Characters (Continued)					
DEC	HEX	CP 1252	ASCII	Alternate Extended	PS2 Scan Code
248	F8	ø	°		
249	F9	ù	·		
250	FA	ú	·		
251	FB	û	√		
252	FC	ü	n		
253	FD	ý	²		
254	FE	þ	■		
255	FF	ÿ			

ISO 2022/ISO 646 Character Replacements

Code pages define the mapping of character codes to characters. If the data received does not display with the proper characters, it may be because the barcode being scanned was created using a code page that is different from the one the host program is expecting. If this is the case, select the code page with which the barcodes were created. The data characters should then appear properly.

Code Page Selection Method/ Country	Standard	Keyboard Country	Honeywell Code Page Option
United States (standard ASCII)	ISO/IEC 646-IRV	n/a	1
Automatic National Character Replacement	ISO/IEC 2022	n/a	2 (default)
Binary Code page	n/a	n/a	3
Default "Automatic National Character replacement" will select the below Honeywell Code Page options for Code128, Code 39 and Code 93.			
United States	ISO/IEC 646-06	0	1
Canada	ISO /IEC 646-121	54	95
Canada	ISO /IEC 646-122	18	96
Japan	ISO/IEC 646-14	28	98
China	ISO/IEC 646-57	92	99
Great Britain (UK)	ISO /IEC 646-04	7	87
France	ISO /IEC 646-69	3	83
Germany	ISO/IEC646-21	4	84
Switzerland	ISO /IEC 646-CH	6	86
Sweden / Finland (extended Annex C)	ISO/IEC 646-11	2	82
Ireland	ISO /IEC 646-207	73	97
Denmark	ISO/IEC 646-08	8	88
Norway	ISO/IEC 646-60	9	94
Italy	ISO/IEC 646-15	5	85
Portugal	ISO/IEC 646-16	13	92

Code Page Selection Method/ Country	Standard	Keyboard Country	Honeywell Code Page Option
Spain	ISO/IEC 646-17	10	90
Spain	ISO/IEC 646-85	51	91

Dec			35	36	64	91	92	93	94	96	123	124	125	126
Hex			23	24	40	5B	5C	5D	5E	60	7B	7C	7D	7E
US	0	1	#	\$	@	[\]	^	`	{		}	~
CA	54	95	#	\$	à	â	ç	ê	î	ô	é	ù	è	û
CA	18	96	#	\$	à	â	ç	ê	É	ô	é	ù	è	û
JP	28	98	#	\$	@	[¥]	^	`	{		}	-
CN	92	99	#	¥	@	[\]	^	`	{		}	-
GB	7	87	£	\$	@	[\]	^	`	{		}	~
FR	3	83	£	\$	à	°	ç	§	^	μ	é	ù	è	¨
DE	4	84	#	\$	§	Ä	Ö	Ü	^	`	ä	ö	ü	ß
CH	6	86	ù	\$	à	é	ç	ê	î	ô	ä	ö	ü	û
SE/FI	2	82	#	¤	É	Ä	Ö	Å	Ü	é	ä	ö	å	ü
DK	8	88	#	\$	@	Æ	Ø	Å	^	`	æ	ø	å	~
NO	9	94	#	\$	@	Æ	Ø	Å	^	`	æ	ø	å	-
IE	73	97	£	\$	Ó	É	Í	Ú	Á	ó	é	í	ú	á
IT	5	85	£	\$	§	°	ç	é	^	ù	à	ò	è	ì
PT	13	92	#	\$	§	Ã	Ç	Õ	^	`	ã	ç	õ	°
ES	10	90	#	\$	§	i	Ñ	¿	^	`	°	ñ	ç	~
ES	51	91	#	\$	·	i	Ñ	Ç	¿	`	·	ñ	ç	¨
COUNTRY	Country Keyboard	Honeywell CodePage	ISO / IEC 646 National Character Replacements											

Keyboard Key References

6E	70	71	72	73	74	75	76	77	78	79	7A	7B	7C	7D	7E					
01	02	03	04	05	06	07	08	09	0A	0B	0C	0D	0F	4B	50	55	5A	5F	64	69
10	11	12	13	14	15	16	17	18	19	1A	1B	1C	1D	4C	51	56	5B	60	65	6A
1E	1F	20	21	22	23	24	25	26	27	28	29	2B				5C	61	66		
2C	2E	2F	30	31	32	33	34	35	36	37	39	53	5D	62	67				6C	
3A	3B	3C			3D				3E	3F	38	40	4F	54	59	63	68			

104 Key U.S. Style Keyboard

6E	70	71	72	73	74	75	76	77	78	79	7A	7B	7C	7D	7E					
01	02	03	04	05	06	07	08	09	0A	0B	0C	0D	0F	4B	50	55	5A	5F	64	69
10	11	12	13	14	15	16	17	18	19	1A	1B	1C	2B	4C	51	56	5B	60	65	6A
1E	1F	20	21	22	23	24	25	26	27	28	29	2A				5C	61	66		
2C	2D	2E	2F	30	31	32	33	34	35	36	37	39	53	5D	62	67				6C
3A	3B	3C			3D				3E	3F	38	40	4F	54	59	63	68			

105 Key European Style Keyboard

SAMPLE SYMBOLS

UPC-A

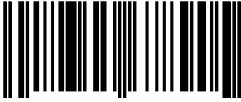

0 123456 7890

Interleaved 2 of 5

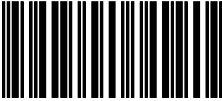

01234567890

EAN-13



9 780330 290951

Code 128



Code 128

Code 39

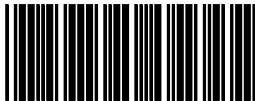

BC321

Codabar



A13579B

Code 93



123456-9\$

Straight 2 of 5 Industrial

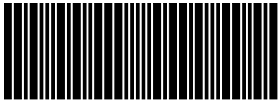

123456

Matrix 2 of 5



6543210

RSS-14



(01) 00123456789012

PDF417



Car Registration

Code 49



1234567890

SAMPLE SYMBOLS (CONTINUED)

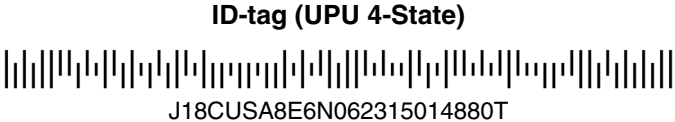
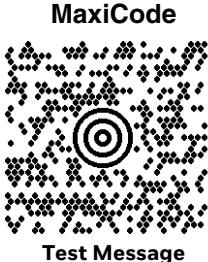

PROGRAMMING CHART



K0K

0



K2K

2



K4K

4



K6K

6



K8K

8



K1K

1



K3K

3



K5K

5



K7K

7



K9K

9

PROGRAMMING CHART (CONTINUED)



KAK
A



KBK
B



KCK
C



KDK
D



KEK
E



KFK
F



MNUSAV.
Save



MNUABT.
Discard



RESET_
Reset

Note: If you make an error while scanning the letters or digits (before scanning **Save**), scan **Discard**, scan the correct letters or digits, and **Save** again.

Honeywell
855 S. Mint St.
Charlotte, SC 28202

sps.honeywell.com